

EG4[®] FLEXBOSS21 HYBRID INVERTER

USER MANUAL



TABLE OF CONTENTS

1.	TECHNICAL SPECIFICATIONS	1
2.	ABBREVIATIONS	3
3.	INVERTER SAFETY	4
3.1	SAFETY INSTRUCTIONS.....	4
3.2	IMPORTANT SAFETY NOTIFICATIONS	4
4.	PACKING LIST	6
5.	PRODUCT DIMENSIONS.....	7
6.	PRODUCT OVERVIEW	11
6.1	FEATURES OVERVIEW	11
6.2	SYSTEM DIAGRAMS.....	12
7.	SYSTEM INSTALLATION	13
7.1	TOOLS NEEDED FOR INSTALLATION.....	13
7.2	LOCATION SELECTION AND INSTALLATION.....	13
7.3	CONNECTION OVERVIEW.....	17
7.4	PV CONNECTIONS	20
7.5	BATTERY CONNECTIONS	23
7.6	AC WIRING INFORMATION.....	25
7.7	PARALLEL SYSTEM CONNECTION	28
7.8	GRID, LOAD, AND AC INFORMATION	31
7.9	RAPID SHUTDOWN/ESS DISCONNECT.....	32
8.	INVERTER START-UP AND SHUTDOWN PROCEDURE.....	33
9.	WORKING WITH A GRIDBOSS.....	33
10.	MONITOR SYSTEM SETUP	34
10.1	WI-FI/4G DONGLE CONNECTION.....	34
10.2	ONLINE MONITORING SYSTEM USER INTERFACE	35
10.3	EG4® MONITOR APP SETUP	35
10.4	ENABLE APP NOTIFICATIONS	37
10.5	LOCAL MONITORING SETUP WITH THE EG4® MONITOR APP.....	39
10.6	THIRD-PARTY RS485 COMMUNICATION.....	39
11.	MONITOR CENTER SETTINGS	40
11.1	COMMON SETTING.....	40
11.2	APPLICATION SETTING.....	41
11.3	SYSTEM GRID CONNECT SETTING.....	42
11.4	CHARGE SETTING.....	43
11.5	DISCHARGE SETTING.....	44
12.	WORKING MODES AND RELATED SETTINGS	45
13.	FIRMWARE UPDATES.....	52
13.1	FIRMWARE UPDATES VIA EG4® ELECTRONICS APP.....	52
13.2	FIRMWARE UPDATE VIA MONITOR CENTER (WEBSITE).....	53
14.	TROUBLESHOOTING AND MAINTENANCE.....	53
14.1	REGULAR MAINTENANCE	53
14.2	LED DESCRIPTION	54
14.3	FAULTS AND ALARMS LIST	54
15.	STANDARDS AND CERTIFICATIONS	57
16.	WARRANTY INFORMATION.....	58
17.	CHANGELOG.....	59

1. TECHNICAL SPECIFICATIONS

AC INPUT DATA				
NOMINAL AC VOLTAGE	120/240VAC; 120/208VAC (L1/L2/N required)			
FREQUENCY	60 Hz (Default) 50 Hz			
MAX. AC CURRENT	50A @ 240V 57.7A @ 208V			
MAX. AC INPUT POWER	12kW			
MAX. AC BYPASS	90A			
AC GRID OUTPUT DATA				
MAX. OUTPUT CURRENT	66.7A			
OUTPUT VOLTAGE	120/240VAC; 120/208VAC (L1/L2/N required)			
OPERATING VOLTAGE RANGE	180 – 270VAC			
NOMINAL POWER OUTPUT	w/ PV: 16000W @240V 13800kW @208V w/ out PV: 12000W @240V 12000W @208V			
OUTPUT FREQUENCY	60 Hz (Default) 50 Hz			
POWER FACTOR	.99 @ Full Load			
REACTIVE POWER ADJUST RANGE	(-0.8) – (+0.8) Leading Adjustable			
THD @ FULL LOAD	<5%			
TRANSFER TIME	20ms (Default), 10ms (Configurable) Parallel – 20ms			
BACKUP/UPS AC OUTPUT DATA				
RATED OUTPUT CURRENT (240 208VAC)	50A 57.7A			
NOMINAL OUTPUT VOLTAGE	120/240 120/208 VAC			
RATED OUTPUT POWER	12kW @ 240VAC 12kW @ 208VAC			
PEAK POWER	24kW (.5 sec)	18kW (1 sec)	15kW (6 min)	13.2kW (12 min)
OPERATING FREQUENCY	60 Hz (Default) 50 Hz			
THDV (TOTAL HARMONIC DISTORTION VOLTAGE)	<5%			
TRANSFER TIME	20ms (Default), 10ms (Configurable), 20ms (Parallel)			
PV INPUT DATA				
NUMBER OF MPPTS	3			
INPUTS PER MPPT	2 (MPPT 1) 2 (MPPT 2) 1 (MPPT 3)			
MAX. USABLE INPUT CURRENT	26A (MPPT 1) 26A (MPPT 2) 15A (MPPT 3)			
MAX. SHORT CIRCUIT INPUT CURRENT	31A (MPPT 1) 31A (MPPT 2) 19A (MPPT 3)			
DC INPUT VOLTAGE RANGE	100 – 600VDC			
UNIT START-UP VOLTAGE	100VDC			
MPPT OPERATING VOLTAGE RANGE	120 – 440VDC			
NOMINAL MPPT VOLTAGE	360VDC			
MAX. UTILIZED SOLAR POWER	21kW			
MAX. RECOMMENDED SOLAR INPUT	25kW			
EFFICIENCY				
CEC	96.9%			
MAX. EFFICIENCY (PV TO GRID)	97%			
MAX. EFFICIENCY (BATTERY TO GRID)	94%			
MAX. EFFICIENCY (PV TO BATTERY)	94.5%			
IDLE CONSUMPTION	<65W			

BATTERY DATA

COMPATIBLE BATTERY TYPES	Lead-acid/ Lithium
MAX. CHARGE/DISCHARGE POWER	12000W
NOMINAL VOLTAGE	48VDC
VOLTAGE RANGE	40 – 60VDC
RECOMMENDED BATTERY CAPACITY PER INVERTER	>300Ah

GENERAL DATA

MAX. UNITS IN PARALLEL	16
PRODUCT DIMENSIONS (H×W×D)	30.43 × 22.28 × 11.22 in. (773 × 566 × 285 mm)
UNIT WEIGHT	88 lbs. (52 kg)
DESIGN TOPOLOGY	High Frequency – Transformerless
RELATIVE HUMIDITY	0 – 100%
OPERATING ALTITUDE	<6561 ft (<2000 m)
OPERATING AMBIENT TEMPERATURE RANGE	-13° – 140°F (-25° – 60°C)
STORAGE AMBIENT TEMPERATURE RANGE	-13° – 140°F (-25° – 60°C)
NOISE EMISSION (TYPICAL)	<50dB @ 3 ft
COMMUNICATION INTERFACE	RS485/Wi-Fi/CAN
STANDARD WARRANTY	10-year standard warranty*
OUTDOOR RATING	NEMA 4X
SAFETY FEATURES	Integrated DC disconnect, Reverse polarity protection, Output over-voltage protection varistor, Output over current protection, Ground fault monitoring, Grid monitoring, Pole sensitive leakage current monitoring unit, AFCI, RSD

STANDARDS AND CERTIFICATIONS

UL1741, SA, SB, PCS CRD
California Rule 21 Phase I, II, III
Arc-Fault Circuit Interrupter (AFCI) NEC 2020:690.11/UL1699B
Ground Fault Monitoring (GFDI) NEC 2020:690.41(B)
CSA 22.2.107.1:2016 Ed. 4
CSA 22.2.330:2017 Ed. 1
IEEE 1547.1:2020; IEEE 1547:2018
Hawaii Rule 14H [HECO SRD IEEE 1547.1-2020 Ed. 2]
Rapid Shutdown (RSD) NEC 2020:690.12
FCC Part 15, Class B (PENDING)

*For information regarding warranty registration on EG4® Electronics products, please navigate to <https://eg4electronics.com/warranty/> and select the corresponding product to begin the registration process.

2. ABBREVIATIONS

- AWG – American Wire Gauge
- A – Amps
- Ah – Amp hour(s)
- AC – Alternating Current
- AFCI – Arc-Fault Circuit Interrupter
- AHJ – Authority Having Jurisdiction
- kAIC – kilo-Amp Interrupting Capability
- ANSI – American National Standards Institute
- BAT – Battery
- BMS – Battery Management System
- COM – Communication
- CT – Current Transformer
- DC – Direct Current
- DIP – Dual In-line Package
- DOD – Depth of Discharge
- EG – Equipment Ground
- EGS – Equipment Grounding System
- EMC – Electromagnetic Compatibility
- EPS – Emergency Power System
- ESS – Energy Storage System
- E-Stop – Emergency Stop
- FCC – Federal Communication Commission
- GE – Grounding Electrode
- GEC – Grounding Electrode Conductor
- GFCI – Ground Fault Circuit Interrupter
- GFDI – Ground Fault Detector/Interrupter
- Imp – Maximum Power Point Current
- IEEE – Institute of Electrical and Electronic Engineers
- IP – Ingress Protection
- I_{sc} – Short-Circuit Current
- In-lbs. – Inch Pounds
- kW – Kilowatt
- kWh – Kilowatt-hour
- LCD – Liquid Crystal Display
- LFP – Lithium Iron Phosphate
- L1 – Line 1
- L2 – Line 2
- mm – Millimeters
- MPPT – Maximum Power Point Tracking
- mV – Millivolt
- N – Neutral
- NEC – National Electric Code
- NEMA – National Electrical Manufacturers Association
- NFPA – National Fire Prevention Association
- Nm – Newton Meters
- NOCT – Normal Operating Cell Temperature
- PC – Personal Computer
- PCB – Printed Circuit Board
- PE – Protective Earth
- PPE – Personal Protective Equipment
- PV – Photovoltaic
- RSD – Rapid Shut Down
- SCC – Standards Council of Canada
- SOC – State of Charge
- STC – Standard Testing Conditions
- UL – Underwriters Laboratories
- UPS – Uninterrupted Power Supply
- V – Volts
- VOC – Open-Circuit Voltage
- VMP – Voltage Maximum Power

3. INVERTER SAFETY

3.1 SAFETY INSTRUCTIONS

International safety regulations have been strictly observed in the design and testing of the inverter. Before beginning any work, carefully read all safety instructions, and always observe them when working on or with the inverter. The installation must follow all applicable national or local standards and regulations.

Incorrect installation may cause:

- Injury or death to the installer, operator or third party
- Damage to the inverter or other attached equipment

3.2 IMPORTANT SAFETY NOTIFICATIONS



DANGER:

There are various safety concerns that must be carefully observed before, during, and after the installation, as well as during future operation and maintenance. The following are important safety notifications for the installer and any end users of this product under normal operating conditions.

1. **Beware of high PV voltage.** Install an external DC disconnect switch or breaker and ensure it is in the “off” or “open” position before installing or working on the inverter. Use a voltmeter to confirm there is no DC voltage present to avoid electric shock.
2. **Beware of high grid voltage.** Ensure the AC switch and/or AC breaker are in the “off” or “open” position before installing or working on the inverter. Use a voltmeter to confirm there is no voltage present to avoid electric shock.
3. **Beware of high battery current.** Ensure that the battery module breakers and/or on/off switches are in the “open” or “off” position before installing or working on the inverter. Use a voltmeter to confirm there is no DC voltage present to avoid electric shock.
4. **Do not open the inverter while it is operating to avoid electric shock and damage from live voltage and current within the system.**
5. Do not make any connections or disconnections (PV, battery, grid, communication, etc.) while the inverter is operating.
6. An installer should make sure to be well protected by reasonable and professional insulative equipment [e.g., personal protective equipment (PPE)].
7. Before installing, operating, or maintaining the system, it is important to inspect all existing wiring to ensure that it meets the appropriate specifications and conditions for use.
8. Ensure that the PV, battery, and grid connections to the inverter are secure and proper to prevent damage or injuries caused by improper installation.
9. Some components of the system can be very heavy. Be sure to utilize team-lift among other safe lifting techniques throughout the installation.



WARNING: TO REDUCE THE RISK OF INJURY, READ ALL INSTRUCTIONS!

All work on this product (system design, installation, operation, setting, configuration, and maintenance) must be carried out by qualified personnel. To reduce the risk of electric shock, do not perform any servicing other than those specified in the operating instructions unless qualified to do so.

1. Read all instructions before installing. For electrical work, follow all local and national wiring standards, regulations, and these installation instructions.
2. Make sure the inverter is properly grounded. All wiring should be in accordance with the National Electrical Code (NEC), ANSI/NFPA 70.
3. The inverter and system can inter-connect with the utility grid only if the utility provider permits. Consult with the local AHJ (Authority Having Jurisdiction) before installing this product for any additional regulations and requirements for the immediate area.
4. All warning labels and nameplates on the inverter should be clearly visible and must not be removed or covered.
5. The installer should consider the safety of future users when choosing the inverter's correct position and location as specified in this manual.
6. Keep children from touching or misusing the inverter and relevant systems.
7. **Beware!** The inverter and some parts of the system can be hot when in use. Do not touch the inverter's surface or most of the parts when they are operating. During operation, only the LCD and buttons should be touched.



WARNING!

Cancer and Reproductive Harm – See www.P65Warnings.ca.gov for more details.

DISCLAIMER

EG4® reserves the right to make changes to the material herein at any time without notice. Please refer to www.eg4electronics.com for the most updated version of our manuals/spec sheets.

4. PACKING LIST

When the product is unpacked, the contents should match the list below.

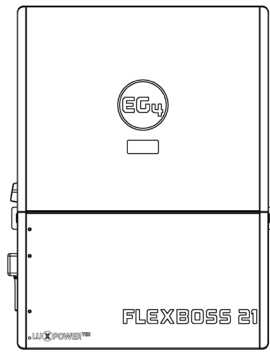

Hybrid Inverter

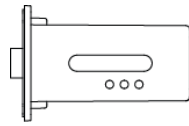

Wi-Fi Dongle

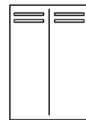

**Wall Mount
Template**



1" CT (x2)

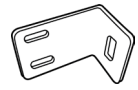

L Bracket (x2)

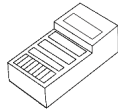

**RJ45 Terminals
(x4)**

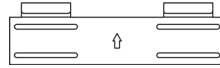

Mounting Bracket

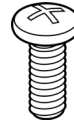

**Phillips Head
Screw M5x10 (x4)**

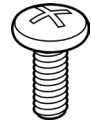

**Phillips Head
Screw M3x10 (x4)**

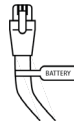

**Battery
Communication
Cable L=2m x 1
(Orange)**

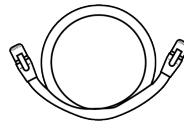

**Parallel
Communication
Cable L=2m x 1
(Grey)**

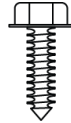

**Self-Tapping
Screws (x6)**



**Expansion Bolts
(x6)**

Pictures for reference only, subject to product availability.

5. PRODUCT DIMENSIONS



LABEL	COMPONENT	DESCRIPTION
A	Handles	Use for installation. See section 7.2.
B	LED Panel	Used to quickly monitor system status. See section 14.3
C	PV Disconnect Switch	Used to connect and disconnect power from solar panels. See section 7.4
D	Clasps	Use to open cable box. See section 7.3
E	Wi-Fi Dongle	Used to communicate with Monitor Center app or website. See section 10.1
F	RSD Button	Rapid Shut Down. See section 7.9

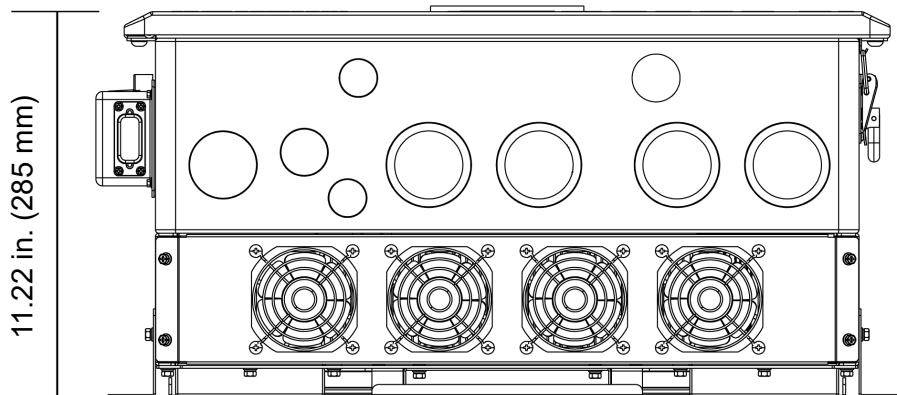
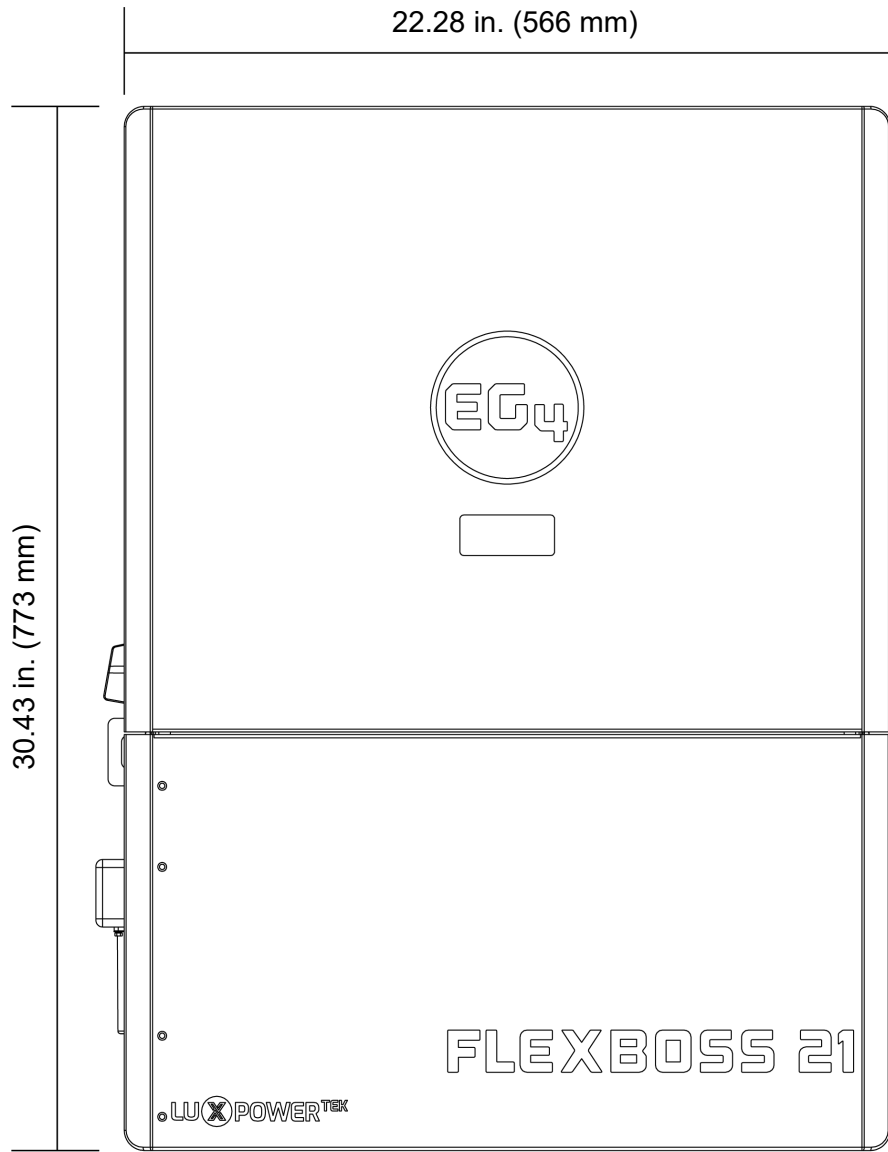

Bottom View of Cable Box

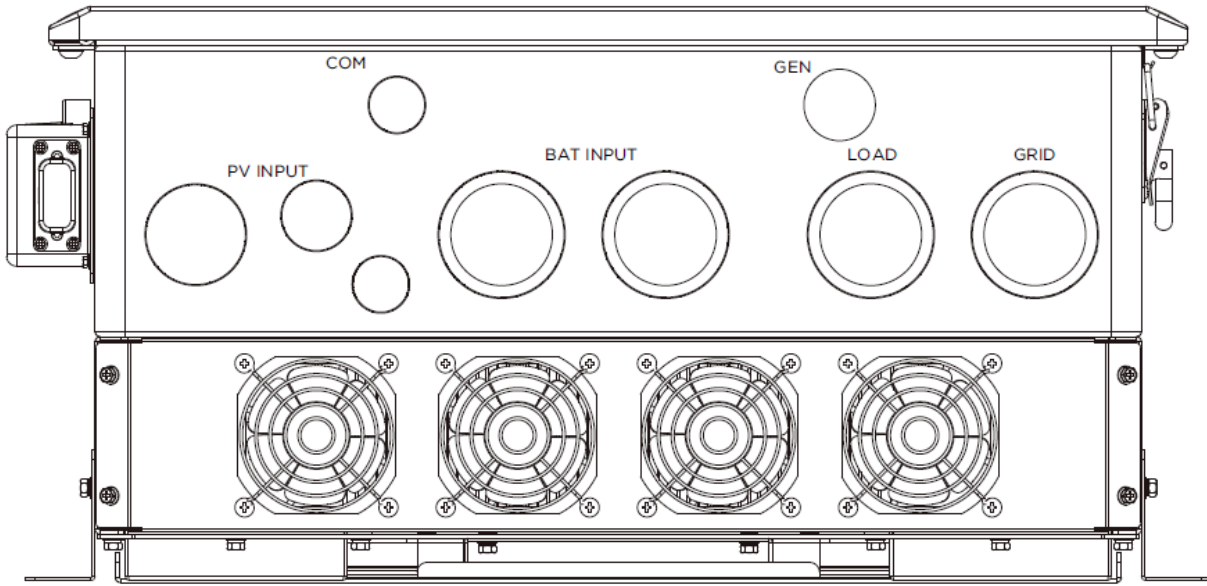

Bottom View of Cable Box Knockouts

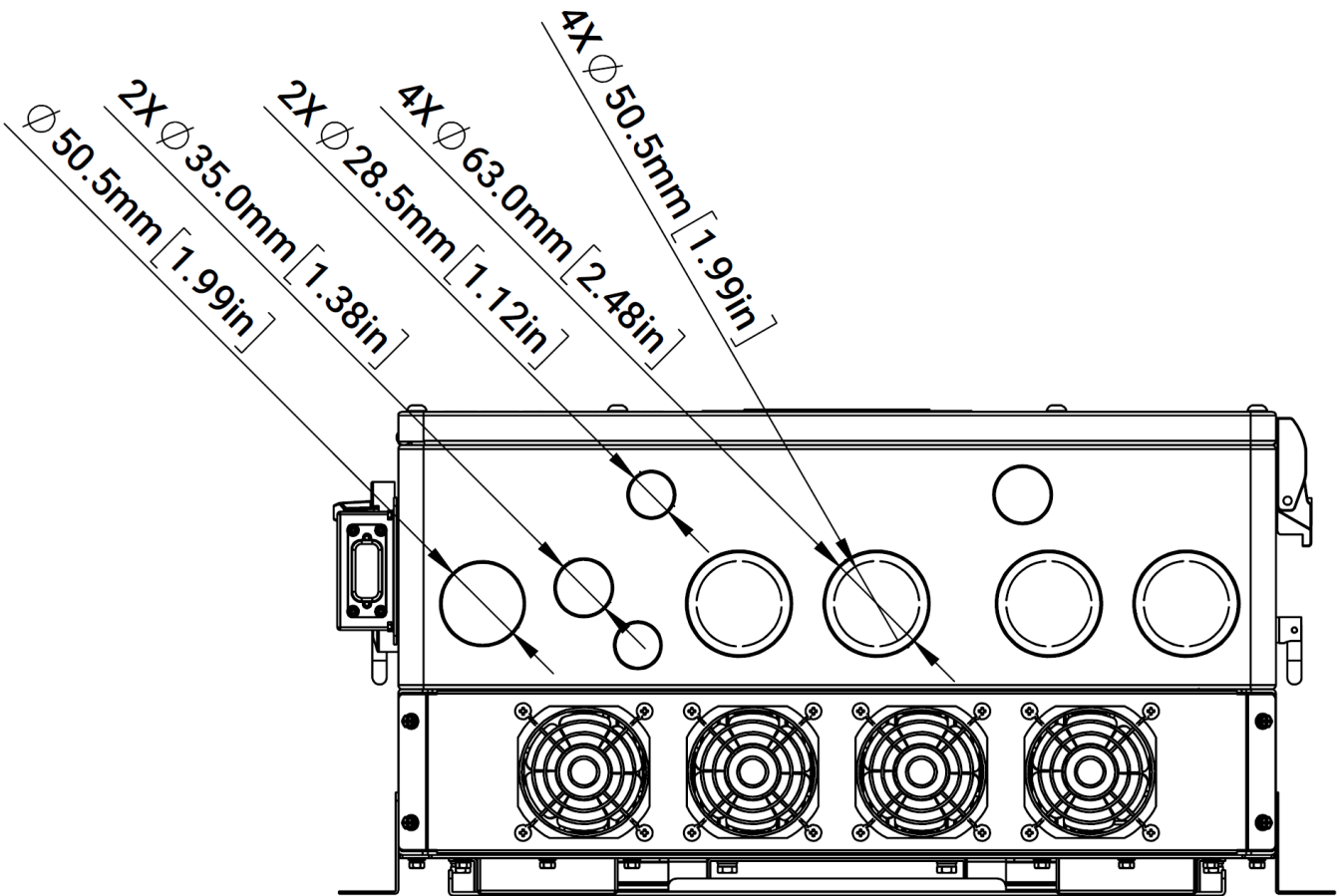

Back View of Cable Box Knockouts

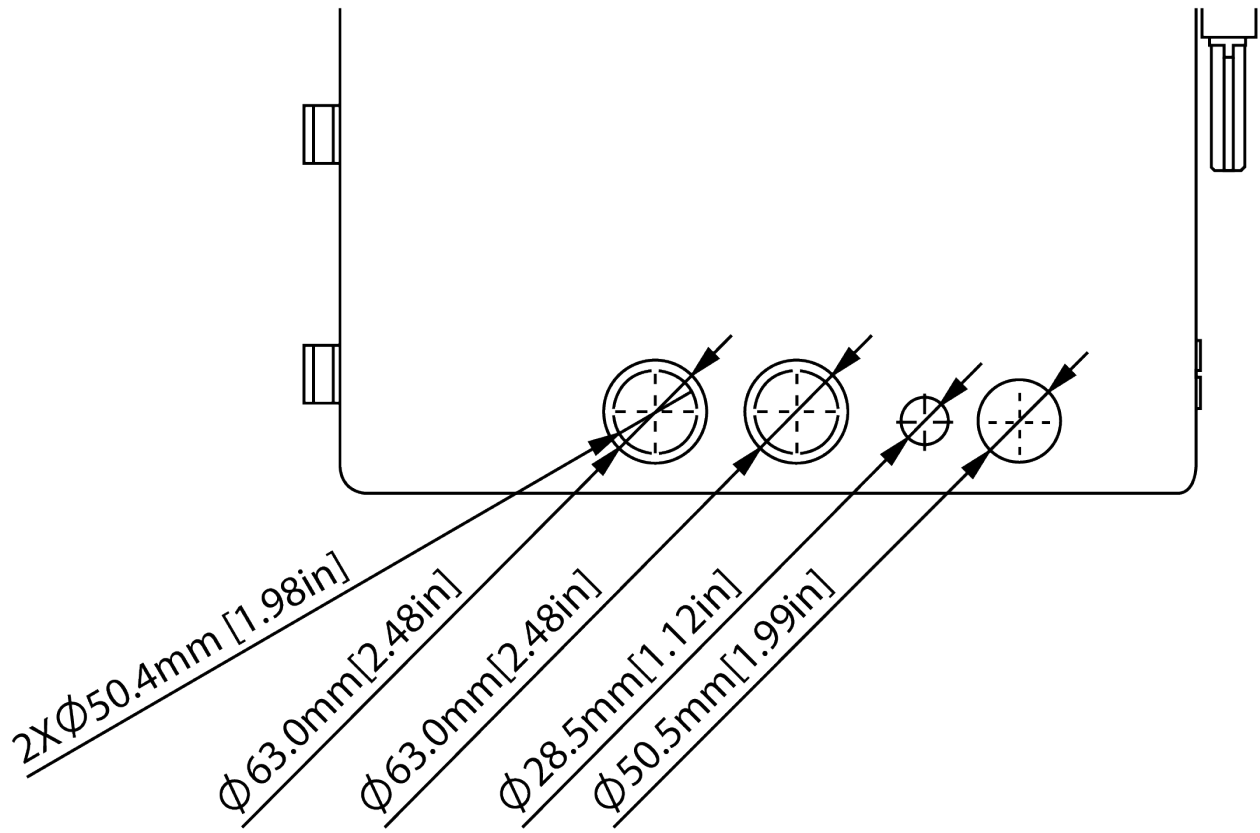

U.S. NOM. TRADE SIZE	ACTUAL KNOCKOUT SIZE
1/2 in.	0.88 in. (22.2 mm)
3/4 in.	1.12 in. (28.5 mm)
1 in.	1.38 in. (35 mm)
1 1/4 in.	1.73 in. (44 mm)
1 1/2 in.	1.99 in. (50.5 mm)
2 in.	2.48 in. (63 mm)

6. PRODUCT OVERVIEW

The EG4® FlexBOSS21 is a 16kW, 120/240VAC split-phase, all-in-one, hybrid, sine wave inverter designed for the residential and small commercial markets. The FlexBOSS21 can utilize 21kW of DC (STC) solar PV on three MPPTs (26/26/15A) and can generate 12kW of power during non-sunlight conditions and 16kW with solar PV gain when connected to the grid. It can bypass 90A of utility power from its grid port to load port. The FlexBOSS21 is an enhanced power-level cousin to EG4's flagship 18kPV inverter. Though it can perform as a standalone inverter, it has been designed to work optimally with EG4's GridBOSS power gateway. This unique pairing unlocks an even more robust feature-set and level of performance for the end user.

6.1 FEATURES OVERVIEW

- FlexBOSS21 is a split-phase hybrid inverter that has the ability to operate off and on the grid.
- Designed for rural and suburban homeowners, and small commercial companies seeking energy savings and independence.
- Charge batteries and power loads simultaneously as users harness multiple power sources, including photovoltaic (PV), battery storage, as well as the grid.
- Supports up to 25kW of DC (STC) solar PV input while producing 16kW of continuous AC output, even during battery charging, positioning it as an effective option for those looking to implement a robust Energy Storage System (ESS).
- Incorporates MPPTs, a bi-directional DC-AC inverter, grid interaction, and battery connectivity. Supports closed-loop communications with all EG4® batteries and a wide selection of third-party batteries using CAN/RS485 protocols.
- Three MPPT solar charge controllers support a PV input of 600V with an optimal range of 120VDC – 440VDC. The three MPPTs allow for flexibility in paralleling strings. MPPT 1 and 2 allow up to 26A each, while MPPT 3 allows 15A, for a total of 21kW of utilized solar power.
- Rated for 12kW continuous output without PV, and 16kW continuous output when utilizing PV and grid connection, with a power factor of 1.
- Features a comprehensive list of certifications that ensure code compliance while offering additional safety and reliability. Fully compliant safety features include PV Arc Fault Protection, PV Ground Fault Protection, PV Reverse Polarity Protection, Pole Sensitive Leakage Current Monitoring Unit, Surge Protection, Integrated PV Disconnect, built-in RSD transmitter, and RSD/ESS disconnect initiator.
- Modular design allows for expansion, adapting to growing energy needs and securing future efficiency in solar investment. Supports up to 16 inverters in a parallel configuration.
- Users can monitor system performance and perform updates remotely via the EG4® Monitoring website and mobile app, ensuring control and flexibility.
- Full AC coupling, generator, and smart loads capabilities when used with GridBOSS.

6.2 SYSTEM DIAGRAMS

This unit and its associated system are suitable for the following applications:

WITHOUT GRIDBOSS

Grid-Tie Only



- Maximize Solar Offset
- Low Initial Cost - Simple
- No Storage
- No Solar when Grid down

Grid-Tie w Battery Backup (GTBB)

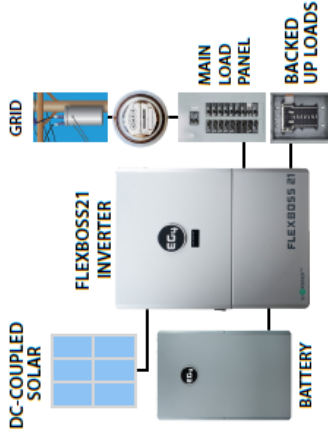

- Modest system for infrequent outages & partial home backup

Fully Off-Grid

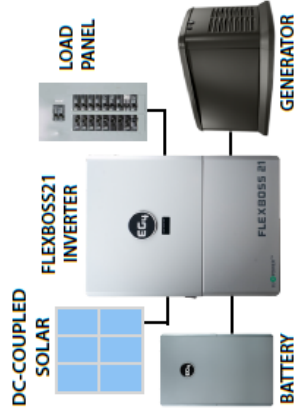

- Remote - No Grid
- Grid Expensive
- Add Grid Backup Later
- Self-Reliance
- Energy Autonomy

WITH GRIDBOSS

Minimize or Optimize Net Energy Metering

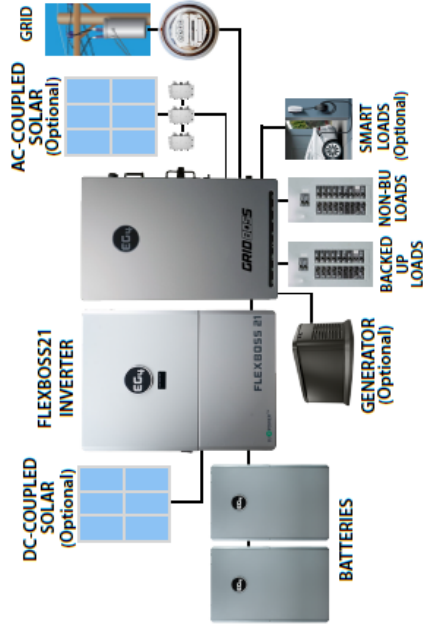

Larger Systems Using Multiple Inverters

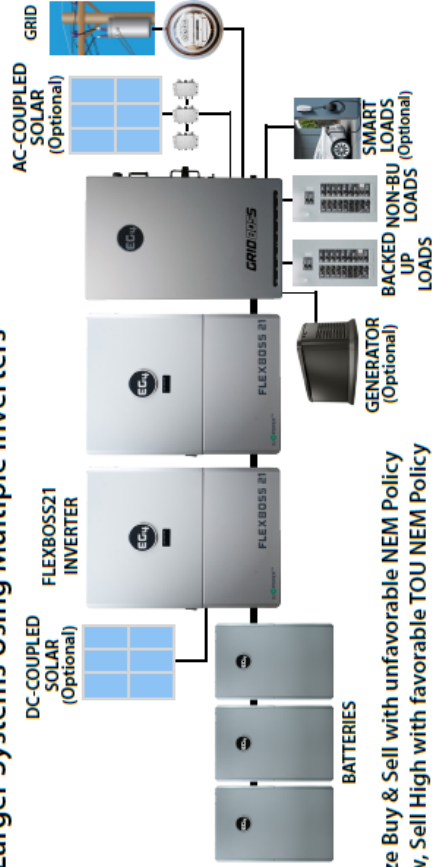

- Minimize Buy & Sell with unfavorable NEM Policy
- Buy Low, Sell High with favorable TOU NEM Policy
- Reduce Demand Charges
- Smart Loads allow for Whole-Home Backup
- Off-Grid Capable

7. SYSTEM INSTALLATION

7.1 TOOLS NEEDED FOR INSTALLATION

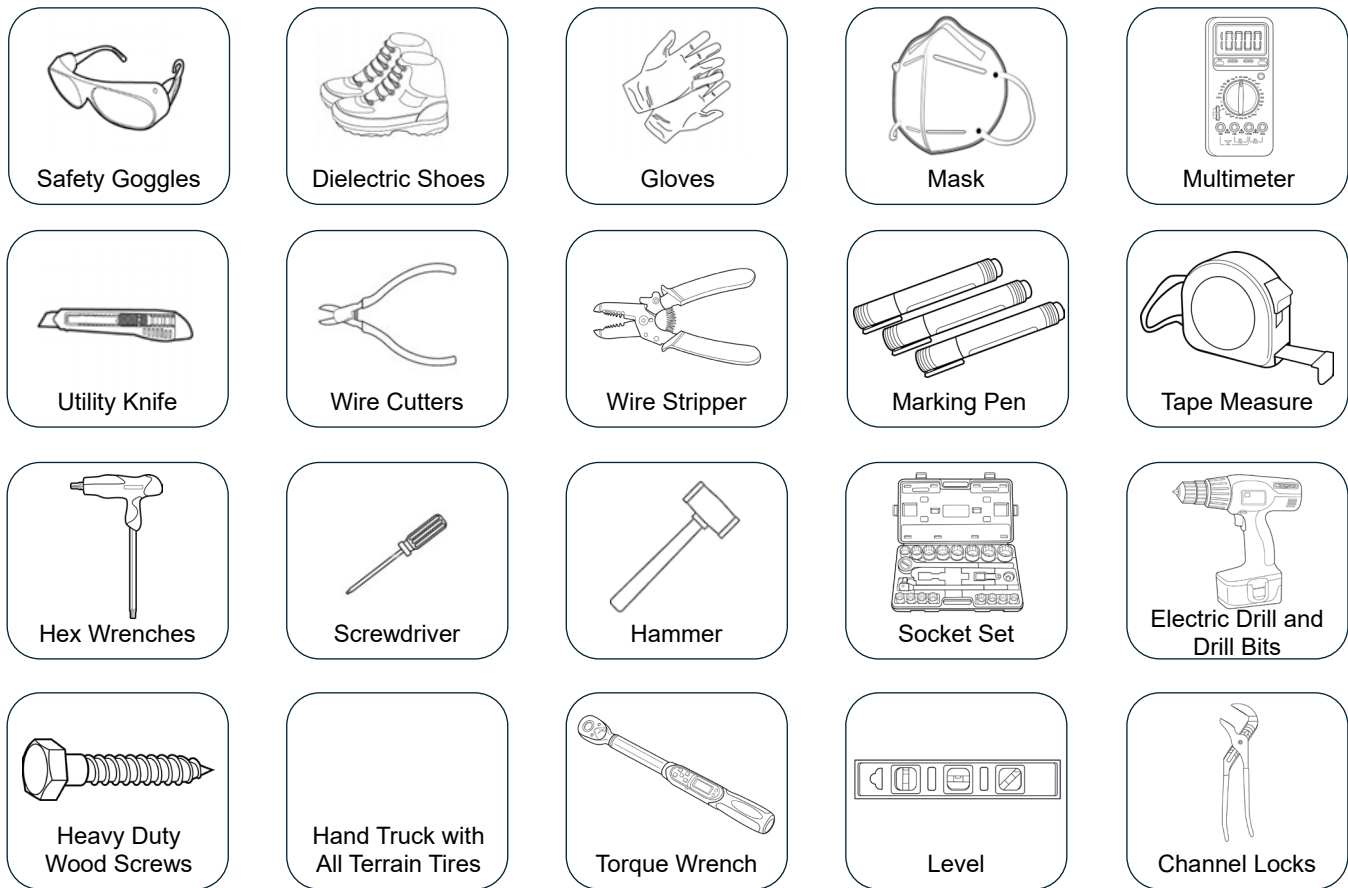

7.2 LOCATION SELECTION AND INSTALLATION

Requirements for Installation



DANGER:

Ensure there is at least 5.91 inches (150 mm) of space around the inverter for heat to dissipate or else there is a risk of fire. Ensure the inverter is mounted away from all combustible materials.

1. The mounting wall should be strong enough to bear the weight of the inverter.
2. Maintain the minimum clearances presented below for adequate heat dissipation.

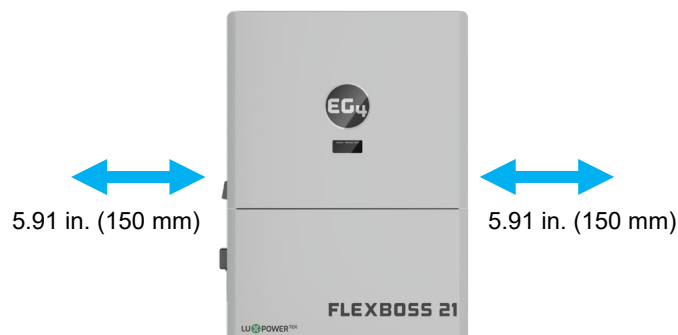

- Never position the inverter in direct sunlight, rain, or snow. Refer to the figure below and choose a well-shaded site or in an indoor location to protect the inverter from the elements. The inverter should be installed upright on a vertical surface.

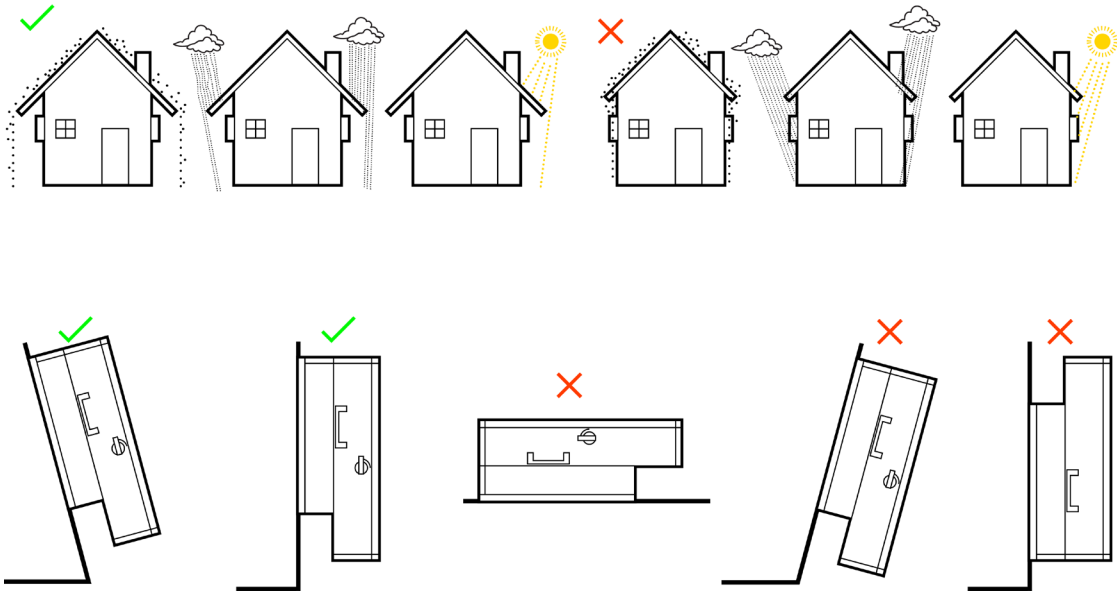

Installing the Inverter

The inverter is designed to be wall-mounted on a vertical, solid, **non-combustible** surface such as brick or concrete. Two or more people may be needed to install the inverter due to its weight. The slots on the mounting bracket can accommodate various stud spacings from 12 in. (305 mm) to 16 in. (406 mm).

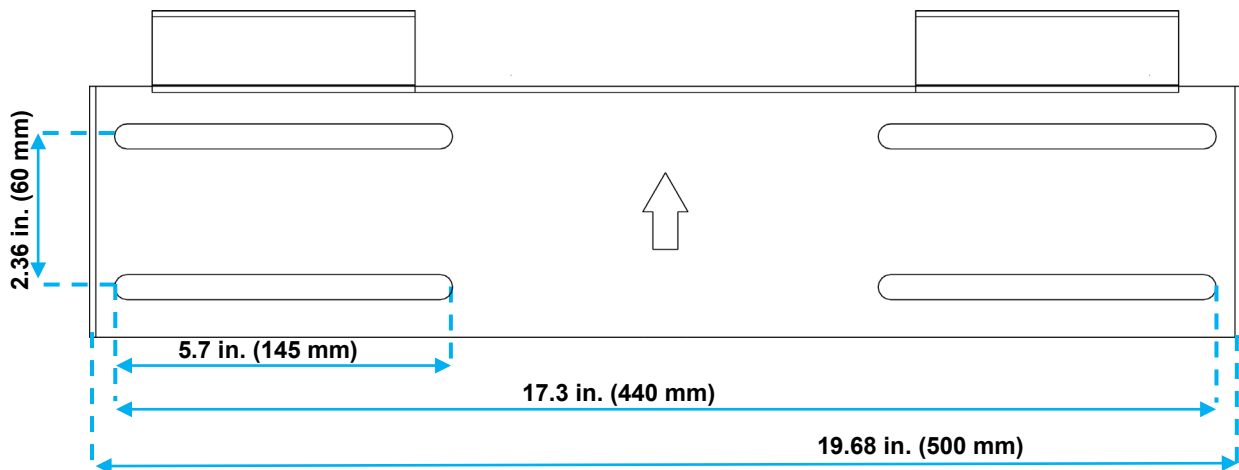

NOTE:

Ensure the mounting surface can support the weight of the unit and has proper spacing per the diagram above.

Mounting Steps

1. Select a location for the inverter's final placement.
2. Use the wall mounting template to mark where the mounting bracket screws will be installed. Use a level to ensure the bracket will be installed parallel with the ground.

NOTE: When installing the bracket to studs, verify the marks for the screws are centered over a stud. Ensure proper 12 in. (305 mm) or 16 in. (406 mm) spacing.

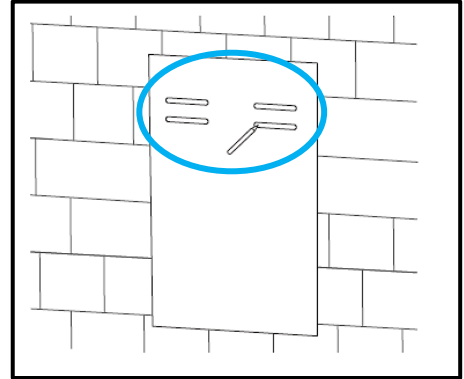

3. When installing the bracket to concrete or brick, drill 5/16 in. (8 mm) diameter holes on the marks, making sure the holes are deeper than 2 in. (50 mm) when using the included expansion bolts.

When installing the bracket to studs, drill a pilot hole sized appropriately for the screw diameter used. Ensure studs are spaced 12 to 16 in. apart.

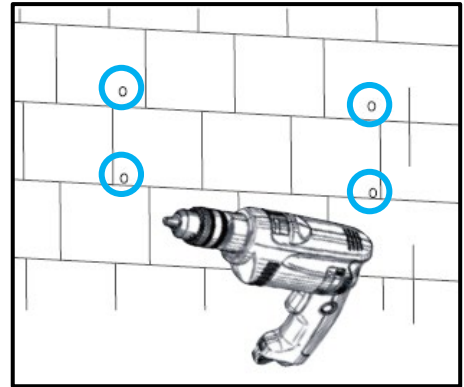

4. For concrete or brick installation, insert the expansion bolts into the drilled holes. Install the bracket to the wall, ensuring the arrow is pointing up. Use the corresponding nuts and washers (packaged together with the expansion bolts) to affix the bracket to the wall. For stud wall installation, use the proper screws and affix the bracket to the wall.

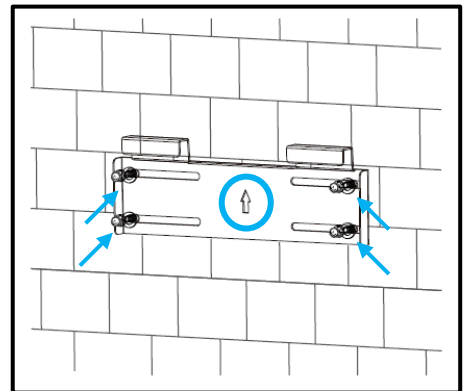

- Using the team lift technique, place the inverter onto the wall bracket, securing it to the wall.

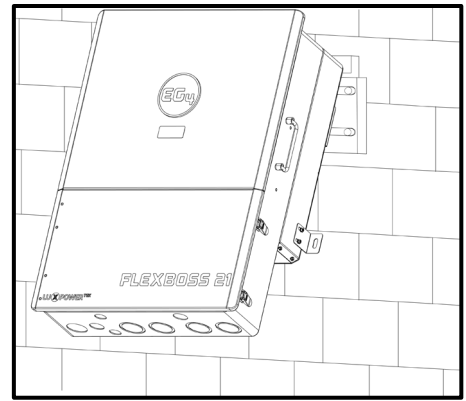

- Temporarily mount the L bracket to the side of the inverter (located at the bottom, one on each side). Mark holes on the wall based on the hole location on the L bracket (repeat this step for both sides).

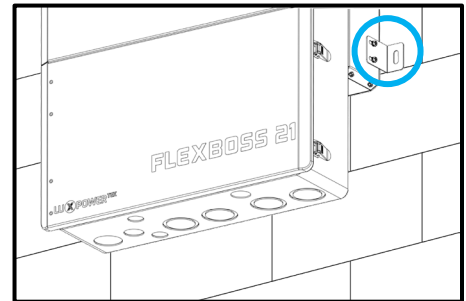

- Remove the L bracket and drill a hole at the marking. Use the drill bit size based on the anchor type or screw size as directed in step 3 (repeat this step for both sides).

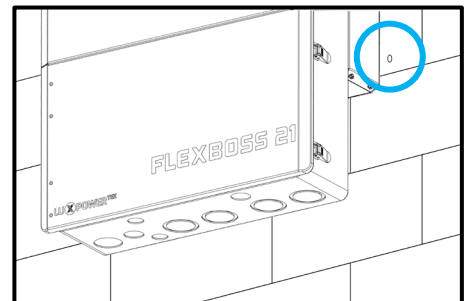

- Attach the L brackets (one on each side) to the inverter and to the wall using the correct hardware. Once the bracket is secure, the wall installation is complete.

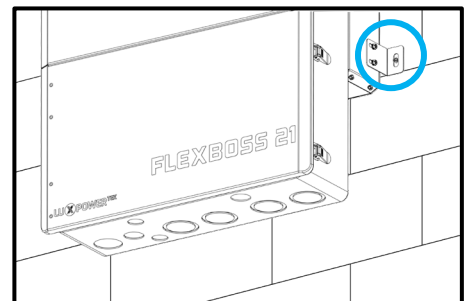

7.3 CONNECTION OVERVIEW

To expose the cable box area, open the bottom cover by opening the clasps on the side of the inverter and remove the three screws on the internal wire box cover as indicated in the image below.

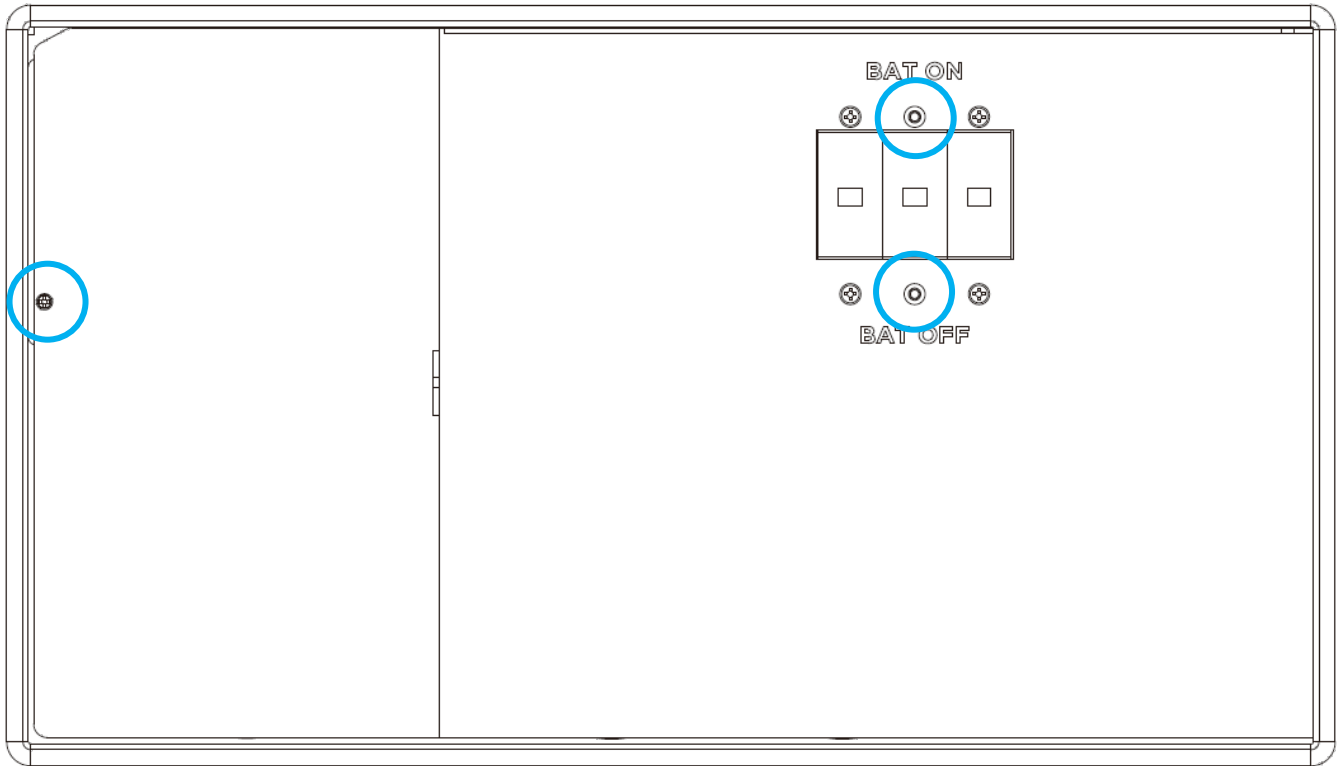

Once the cover is open, follow the sections below for connecting the wiring for PV, battery, AC, paralleled inverters, and rapid shutdown. Before connecting any wiring to the inverter, verify each wire is not carrying voltage using a multimeter.

Breaker selection recommendation for both DC and AC:

BREAKER	RATING
PV Breakers (2P×4)	MMPT 1 string 1: 600V/20A MPPT 1 string 2:600V/20A MMPT 2 string 1: 600V/20A MMPT 2 string 2: 600V/20A MMPT 3 string 1: 600V/20A
Main Breaker (2P)	80A/240Vac when used for partial load backup
Integrated Battery Breaker	300A
Load Breaker	80A/240Vac

Cable Box Overview

LABEL	COMPONENT	DESCRIPTION
A	Communication Board	Used to connect communications cables, set DIP switches, add CTs, and connect external RSD
B	Battery (DC) Connections	Used to connect battery cables
C	Integrated Bonded Battery Breaker	Overcurrent protection for connected batteries
D	AC Connections	Used for wiring AC power from the grid and to the loads
E	PV Input	Used for wiring DC power from solar units to the inverter
F	Protected Earth (Ground Busbar)	Used for ground wiring
G	Neutral Busbar	Used for neutral wiring

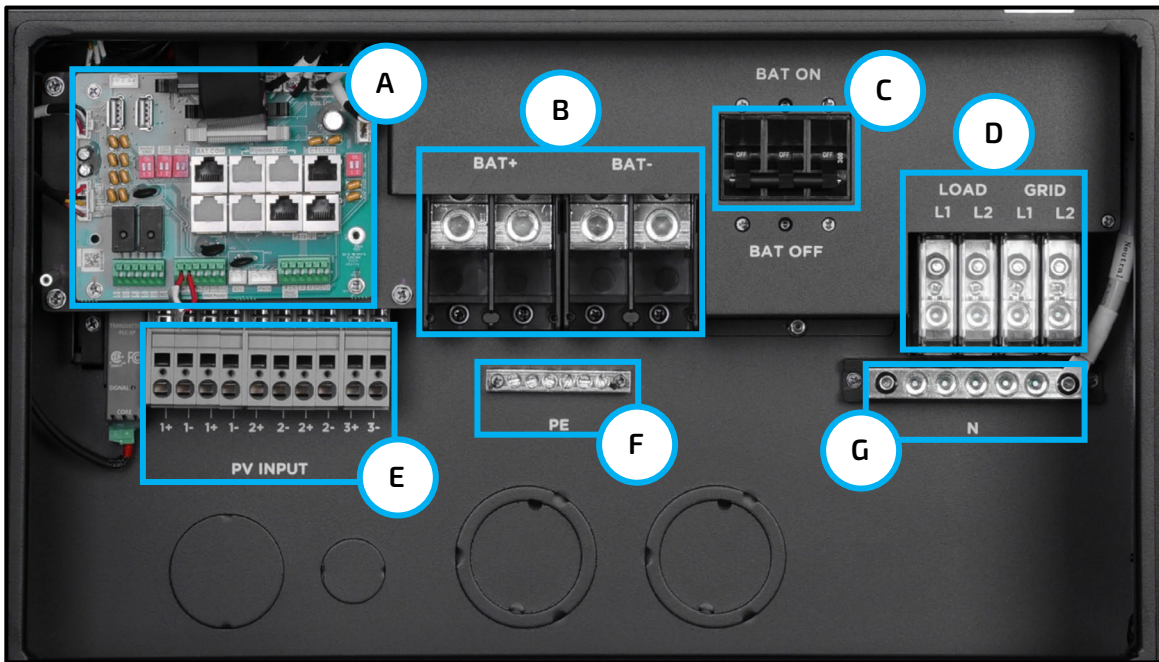

Communication Board Overview

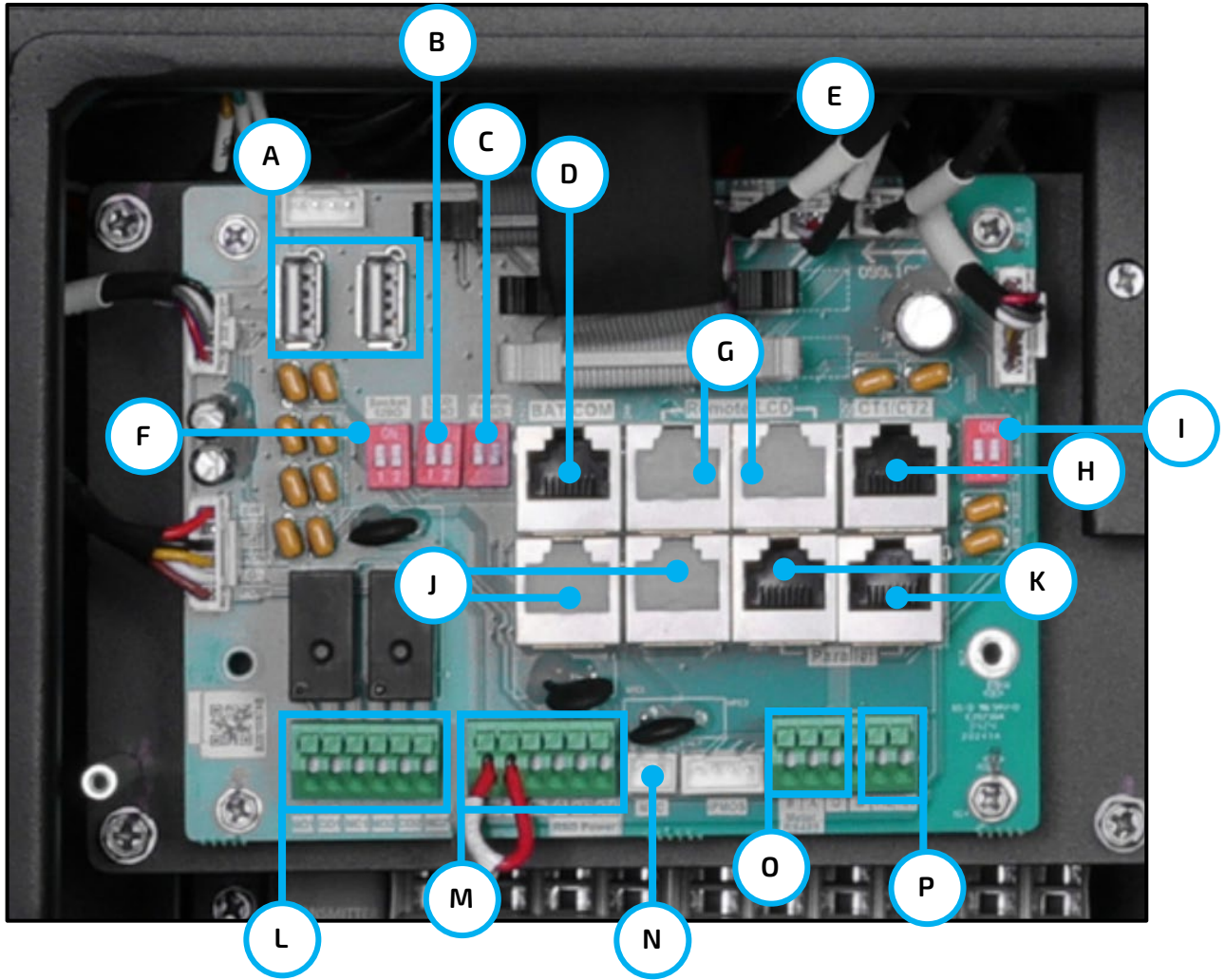

LABEL	DESCRIPTION
A	Reserved
B	Reserved
C	Parallel DIP Switches: Set DIP switches when using inverters in parallel
D	Battery Communication Port (CAN & RS485)
E	Fan Power Supply
F	485 balance resistance
G	Reserved
H	CT Interface
I	Reserved
J	Reserved
K	Paralleling Communication Port
L	DRY (NO, NC): Reserved
M	RSD Terminals
N	NTC: Connection for temperature sensor for lead-acid battery
O	Meter 485B & 485A: For meter communication
P	DC power for customer use, max. 1A

7.4 PV CONNECTIONS

Cable Requirements*:

CABLE SIZE	MINIMUM INSULATOR VOLTAGE	MAX. AMPERAGE PER MPPT
10 AWG – 6 AWG (max.) (6 mm ² – 16 mm ²)	600V	MPPT 1: 26A
		MPPT 2: 26A
		MPPT 3: 15A

*Consult installer to ensure that appropriate cable sizing is used due to various factors such as distance, operating voltage, and amperage.



IMPORTANT:

- Verify the lowest ambient temperature of the installation location. The rated VOC on the solar module nameplate is obtained at STC (77°F/25°C). As the ambient temperature drops, the solar module VOC increases. Ensure the maximum solar string voltage, corrected at the lowest temperature, does not exceed the inverter's maximum input voltage of 600V.
- It is recommended to install a PV disconnect switch between the inverter and PV modules.
- It is very important for system safety and efficient operation to use proper cable for PV module connection as shown in the table above.
- When connecting multiple inverters in parallel, a single string cannot be shared between inverters. Each string must be connected to its own MPPT.

PV INPUT DATA	DESCRIPTION	PARAMETER
DC Input Voltage Range	Range required for the unit to operate up to maximum input	100 – 600VDC
Unit Start-up Voltage	Voltage needed for the unit to turn on	100VDC
Load Output Minimum Voltage	Minimum voltage needed to output power on the load side	>140VDC
MPPT Operating Voltage Range	Range where the MPPT can track	120 – 440VDC
Full Power MPPT Voltage Range	Range where the MPPT operates at maximum capacity	250 – 440VDC
Nominal MPPT Voltage	Voltage at which MPPT will operate most optimally	360VDC
Maximum Utilized Solar Power	Wattage the unit can utilize from the solar array	21kW
Recommended Maximum Solar Input	Suggested PV power input to the device to utilize the full 21kW of PV	25kW

String Sizing

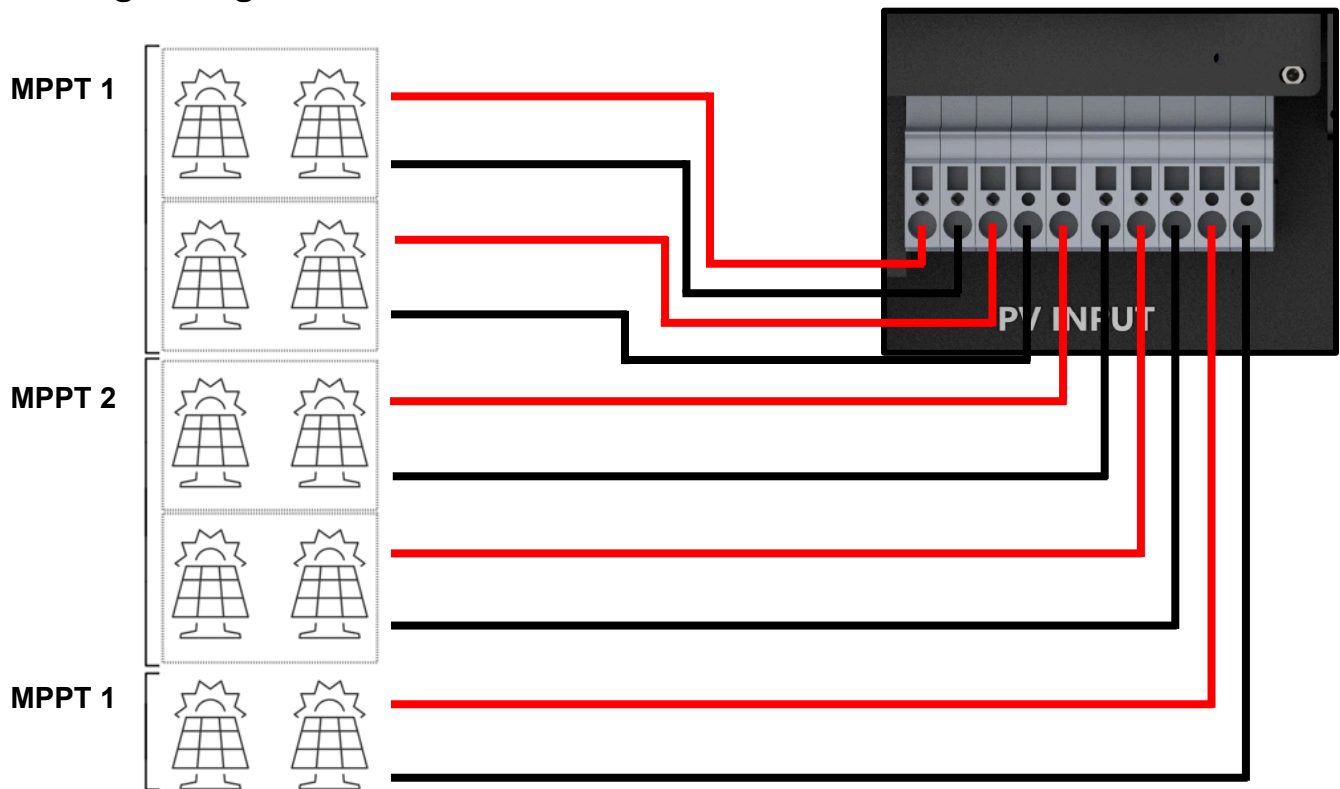

EG4 String Sizer
Tool

- Each string should ideally contain the same model, brand, and quantity of panels for ease of design, racking, and wiring. However, varying string sizes can be used for unique MPPTs. If two strings are used for MPPT 1, they MUST be the same model, brand, and number per string. MPPT 2 and MPPT 3 could differ in model, brand, and number per string (same make/model per string) on the condition that each string complies with the lowest temperature (maximum string number) and maximum amperage calculations.
- When solar modules are put in a series string, the voltage multiplies by the number of modules and the amperage stays the same as each module.
- Calculate the maximum current of the string so as not to exceed the inverter's MPPT circuit ratings. Double check if the calculated VMP range is within the 120 – 440VDC optimal MPPT circuit operating range. Consult a solar designer if needed.
- When solar modules are put in parallel, the amperage multiplies by the number of modules and the total voltage of the string remains equal to the voltage of a single module within the string.
- The inverter has three MPPT inputs: MPPT 1 and MPPT 2 will use up to 26A each which means strings can be paralleled together for any modules having less than a 13A (Imp) rating, ensuring the total amperage does not exceed 26A (Imp). MPPT 3 will use up to 15A which means strings can be paralleled together for any modules having less than 7.5A (Imp), ensuring the total amperage does not exceed 15A (Imp).

- All panels on a series/parallel string should face the same orientation and be exposed to roughly the same shading across the string. Consideration should be placed on string location and wiring order on the racking to minimize shading effects. One shaded module can disproportionately reduce output for the entire string. Optimizers can help counteract the effects of partial shading.
- The maximum utilized solar input of the inverter is 21kW (DC).



NOTE:

For all modules, the calculations need to be performed or verified by using a string calculator (see QR code above) or consulting a professional.



DANGER:

DAMAGE WILL OCCUR if the string voltage on a cold, sunny morning exceeds the inverter's maximum input voltage of 600V!



IMPORTANT:

The array can have a higher I_{mp} than the 26A/15A specified, but the MPPTs will not make full use of the extra current. Having an array that can produce more current than the MPPTs can utilize is useful for increasing morning, winter, or cloudy day solar production. An I_{sc} higher than 31A/19A will cause damage to the inverter.

Steps for PV Wiring:

1. Ensure all breakers and disconnect switches are in the OFF position before connecting or disconnecting wires. Use a voltmeter to confirm there is no voltage present.
2. Strip off 1/4 in. – 5/19 in. (6 mm – 8 mm) insulation on the PV string's positive and negative conductors.

Note: Use wire ferrules for the PV string conductors if they are stranded wires.

3. Insert the conduit fitting into the opening for the PV connection and tighten it from the inside using the counter nut.
4. Route the PV conductors through the conduit fitting and into the inverter.
5. Secure the PV conductors in place into the inverter inputs by inserting a flathead screwdriver into the square and the conductor into the circular input. Verify that they are secured properly by *lightly* pulling on them.
6. Ensure the conduit and conduit fittings are fastened securely and the cable entry holes are sealed.

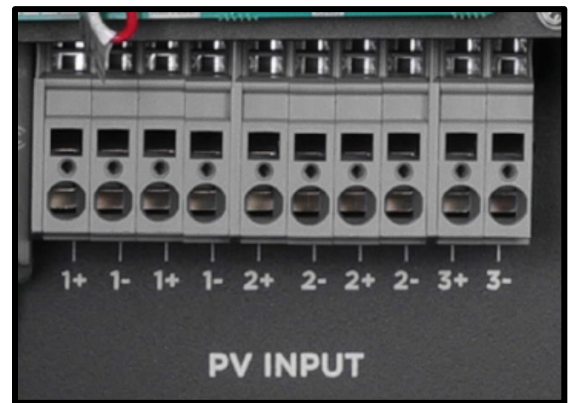

7.5 BATTERY CONNECTIONS

The FlexBOSS21 comes equipped with two battery inputs with 2 positive and 2 negative points of connection. The two positive battery terminals are protected by a 300A breaker. This is to accommodate using parallel conductors as supplied with the WallMount battery series. It is designed to utilize 4 battery cables up to 20 feet by using two sets of cables rather than resorting to larger cable sizes. For safe operation and regulation compliance, install a separate DC over-current protector or disconnect device between battery and inverter.

Cable Requirements*:

NUMBER OF CABLES PER POLE	TOTAL NUMBER OF CABLES	CABLE SIZE	TOTAL CABLE SET AMPACITY	MAX. DISTANCE	TORQUE VALUES
2	4	1/0 AWG (53.5mm ²)	340A	16 ft.	Max. 230 in-lbs. (25.99Nm)
2	4	2/0 AWG (67.4mm ²)	390A	21 ft.	Max. 230 in-lbs. (25.99Nm)
2	4	3/0 AWG (85.0mm ²)	450A	26 ft.	Max. 230 in-lbs. (25.99Nm)
2	4	4/0 AWG (107mm ²)	520A	33 ft.	Max. 230 in-lbs. (25.99Nm)

**Consult installer to ensure that appropriate cable sizing is used due to various factors such as distance, operating voltage, and amperage.*

Cable Installation:

1. Place all breakers in the OFF position before connecting or disconnecting wires. Ensure that there is no voltage present with a voltmeter.
2. Strip 1/4 in. – 5/16 in. (6 mm – 8 mm) of insulation from the cable end.
3. Route the battery power cable, connecting positive (red) to BAT +, and negative (black) to BAT-.
4. Fasten positive and negative battery cables to the mechanical terminals according to the markings with an M8 hex wrench, see torque values above.
5. Verify the positive and negative battery cables are properly connected to the battery bank and the total amp hours meets or exceeds 300Ah.

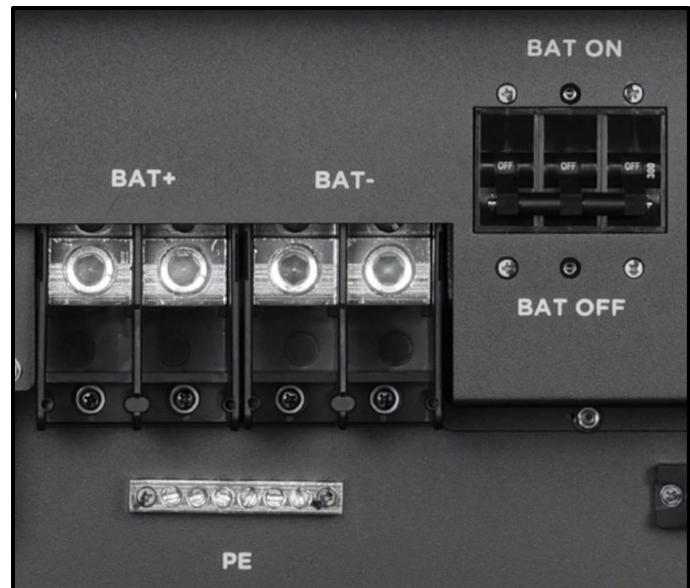

NOTE:

When installing multiple inverters in parallel, battery bank must be connected to each inverter so the current can be evenly shared between each inverter. The positive cable from the battery bank to each inverter should be of equal length. If a busbar is used between the battery bank and the inverter, the cable from the busbar to each inverter should be equal lengths. Each negative cable should be of equal length as well. Using equal length positive cables and equal length negative cables supports equal amperage to each inverter. The positive cables and negative cables do not need to be the same length, only match cable length of the same polarity.

Battery Communication Cable Connections:

- Use the included orange battery communication cable to connect the battery to the inverter. Put the inverter in standby mode to protect batteries until values are set.
- The battery communication port on the inverter is an RJ45 socket with the pinout for the RJ45 plug shown below.
- The inverter supports both CAN and RS485 communication.
- After connecting the battery power and communication cables, go to the Monitor Center app or website. Select “Maintenance,” “Remote Set,” and choose battery type under “Common Settings.”
- For closed-loop communication between the inverter and lithium batteries, choose “Lithium” as the battery type. For inter-battery communication and battery setup with EG4® batteries, refer to the respective battery manual.
- Select the “Lead-Acid” setting if the battery cannot communicate with the inverter. Ensure battery settings are within the battery’s specifications to prevent damaging the battery bank.



NOTE:

If using EG4® LifePower4 batteries in the system, a firmware update may be required for closed-loop communications. Contact the distributor for this file or navigate to <https://www.eg4electronics.com/> for the most recent updates and documentation. For communication with EG4® batteries, select “Lithium” under “Battery Type” and then select “0:EG4” under “Lithium Brand”

For Lithium Batteries:

- EG4® strongly recommends using closed-loop communications between the battery bank and inverter. Ensure the lithium battery being used is compatible with the inverter by visiting [eg4electronics.com](https://www.eg4electronics.com/) for an updated list of third-party batteries capable of closed-loop communication.
- If using multiple batteries modules with the inverter, the inverter communication cable must be connected to the master battery. Check with the battery supplier for battery master and slave settings.

PIN	DESCRIPTION
1	BAT RS485B
2	BAT RS485A
3	NC
4	BAT CAN H
5	BAT CAN L
6	NC
7	NC
8	NC

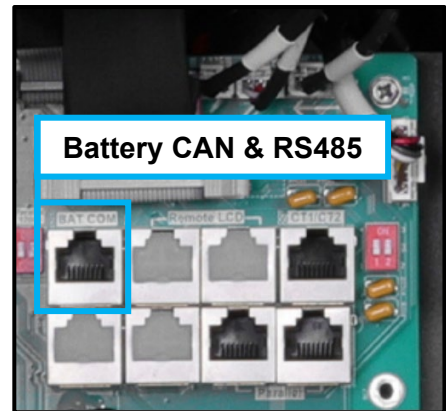

For Lead-Acid Batteries:

Closed loop communication is not available with lead-acid batteries; however, a third-party external temperature sensor will enable the inverter to control the charge/ discharge of the battery. Follow the battery’s manual to determine setting parameters and for more information.

7.6 AC WIRING INFORMATION

When sizing AC wires, adhere to the following information*:

TERMINAL CONNECTION	CABLE SIZE	TORQUE VALUES	MAX. AMPERAGE RATING
Grid	6 – 1 AWG (16 mm ² – 50 mm ²)	93 in-lbs. (10.5Nm)	100A
Load	8 – 6 AWG (10 mm ² – 16 mm ²)	93 in-lbs. (10.5Nm)	50A

**Consult installer to ensure that appropriate cable sizing is used due to various factors such as distance, operating voltage, and amperage.*



NOTE:

- Always be sure to connect the AC Output ground wire to the Ground terminal first before installing the AC Outputs for L1 and L2.
- If using fine stranded wire, use ferrules to secure the connection.
- When installing multiple inverters in parallel, it is recommended to use equal length AC cables from each inverter to the main panel and from each inverter to the loads panel. This helps ensure the load sharing between each inverter is as even as possible.
- If using in conjunction with GridBOSS, the Load port is not used, see the user manual for more information.

Ground-Neutral Bonding

The information below describes the nature of the ground and neutral in the inverter and their relationship to the system. Always consult with an installer or a licensed electrician to ensure that the right configuration is being used:

- The Neutral of the AC input and the AC output are common (known as a Common Neutral Architecture).
- The neutral line between the AC input and AC output is never disconnected.
- The inverter never creates a neutral-ground bond in any mode of operation.



IMPORTANT:

The system should have only one ground-neutral bond (this is typically the Main Bonding Jumper located at the service entrance main breaker).

Steps for AC Connection

The FlexBOSS21 comes equipped with L1 and L2 terminals for AC input (labeled GRID) and output (labeled LOAD). It is designed to utilize up to 50A of input and up to 66.7A of output. These terminals ARE NOT connected to a breaker; it is recommended to install a separate AC breaker between inverter and AC input power source. This will ensure the inverter can be disconnected during maintenance and fully protected from over current AC input. Check with the local AHJ for requirements for means of disconnect.

1. Before connecting or disconnecting AC wires, ensure all breakers are in the OFF position. Check that there is no voltage present with a voltmeter.
2. Strip off 5/16 – 3/8 in. (8 – 10 mm) insulation from the AC cables.
Note: Use wire ferrules if the cables are made of fine stranded wires.
3. Connect the AC ground wire to the ground bus (**Callout 1**).
4. Fasten the neutral wire into the neutral bus (**Callout 4**).

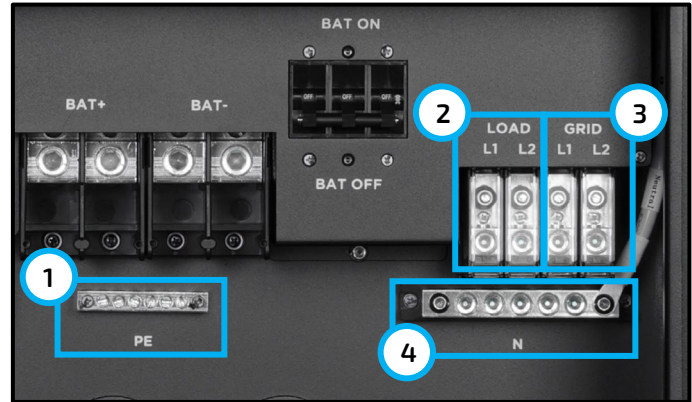

5. Secure the AC wires into their respective mechanical lugs (**Callout 2 and 3**). Connect lines 1 to L1, and lines 2 to L2. Torque to the specifications in the chart above
6. Check that the cables are connected properly. Take appropriate measures to ensure the conduit and conduit fitting are properly secured and seal the cable entry holes.



CAUTION:

- Do not misconnect the grid input and loads output connections, which could cause damage to the inverter and attached devices.
- Be sure to connect AC wires with correct polarity. If L and N wires are connected reversely, it may cause utility to short-circuit when the inverters are working in parallel operation.

CT/Meter Connection

To measure the power imported from and exported to the grid, a pair of CTs or one three-phase meter must be installed at the service entry point in or near the main service panel. Two (2) CTs are provided with each inverter with a 300A rating.

For more information, visit eg4electronics.com.

CT Port Pin Definition:

The CT interface for the two (2) CT connections is an RJ45 port. The two (2) CTs come with a premade plug that can be connected directly to the port.

PIN	DESCRIPTION
1 – 4	Reserved
5	CT2N
6	CT2P
7	CT1N
8	CT1P

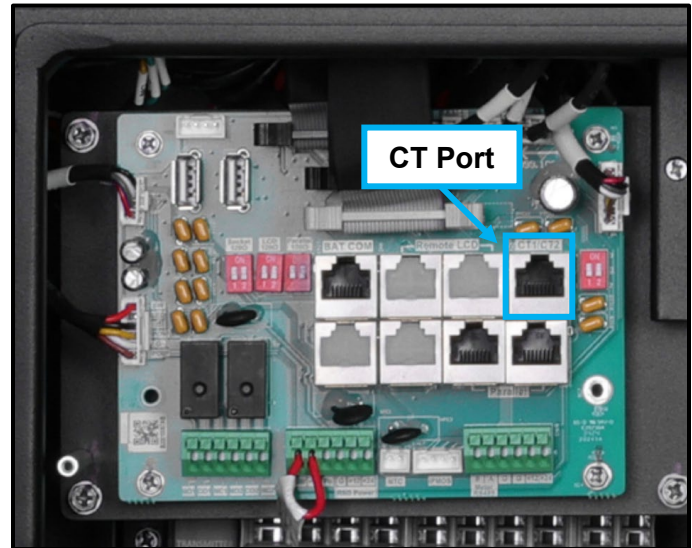

Refer to the connection diagram to the right for the correct position of the CTs. Clamp the 2 CTs onto the L1 and L2 wires at the service entry point in the main service panel as close to the meter base as possible.

The arrows on the CTs must point toward the inverter and be placed on the proper line based on their number. (CT 1 for L1, CT 2 for L2)

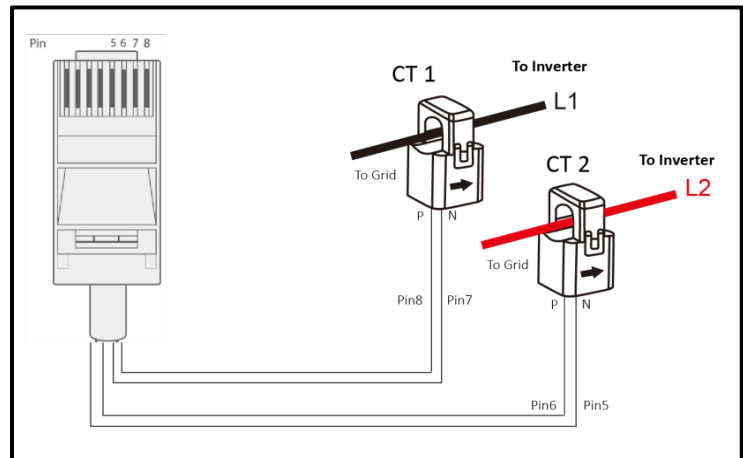

CT Clamp Ratio:

The inverter supports three ratios of CT clamps: 1000:1, 2000:1, and 3000:1. The included CTs are 3000:1.

If using a 3rd party CT, ensure the CT ratio is of the supported types. Be sure to select the correct CT ratio setting on the inverter.

Black= L1

Red= L2

Orange= Neutral

Grey= Communication Cable

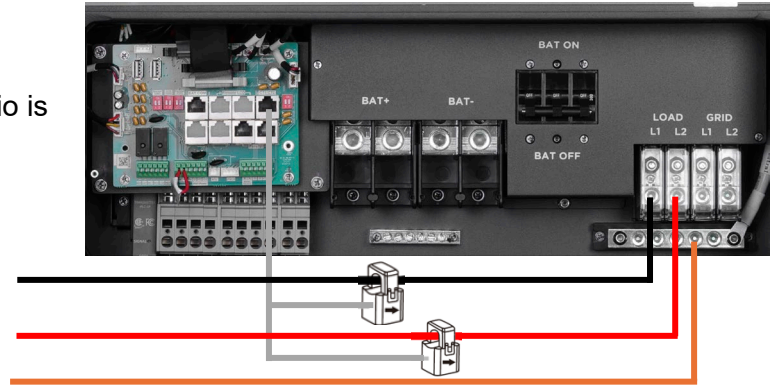

Extending the CT Clamp Cable:

The CT wires can be extended with a common ethernet cable if they are not long enough. An RJ45 adapter is needed for the extension. The CT wires can be extended up to 300 ft. (around 90 m).

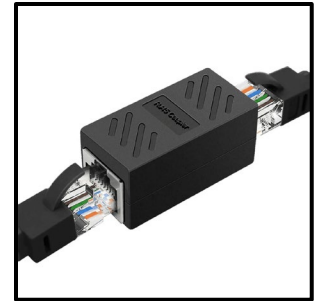

7.7 PARALLEL SYSTEM CONNECTION



REMINDER:

- All setting changes for parallel inverters must be done while in Standby Mode.
- If the system is connected to a lithium battery, the host battery must communicate with the inverter that is set as master in the parallel system.
- Each inverter must be properly configured for parallel mode before outputting current on the loads port. If the proper configuration is not followed, damage could be caused to the inverter and devices connected.
- Keep all settings the same for each inverter in the parallel system on the remote monitor!!
- If the number of PV panels connected to each inverter cannot be evenly divided, it is recommended to have more PV panels on the master inverter.

Connections for Parallel System:

The hybrid inverter supports parallel connection to expand power and energy capacity to suit different usage scenarios. Up to 16 units can be paralleled to reach a capacity of 256kW. The inverters can be used in single phase, or in a three phase system (for three or more inverters). The parallel wiring diagrams are as follows.



REMINDER:

Put the CAN communication pin to ON status for the first and last inverter and OFF for inverters in between.

Both switches in the “ON” position translate to address 1. Both switches in the “OFF” position translates to address 0.

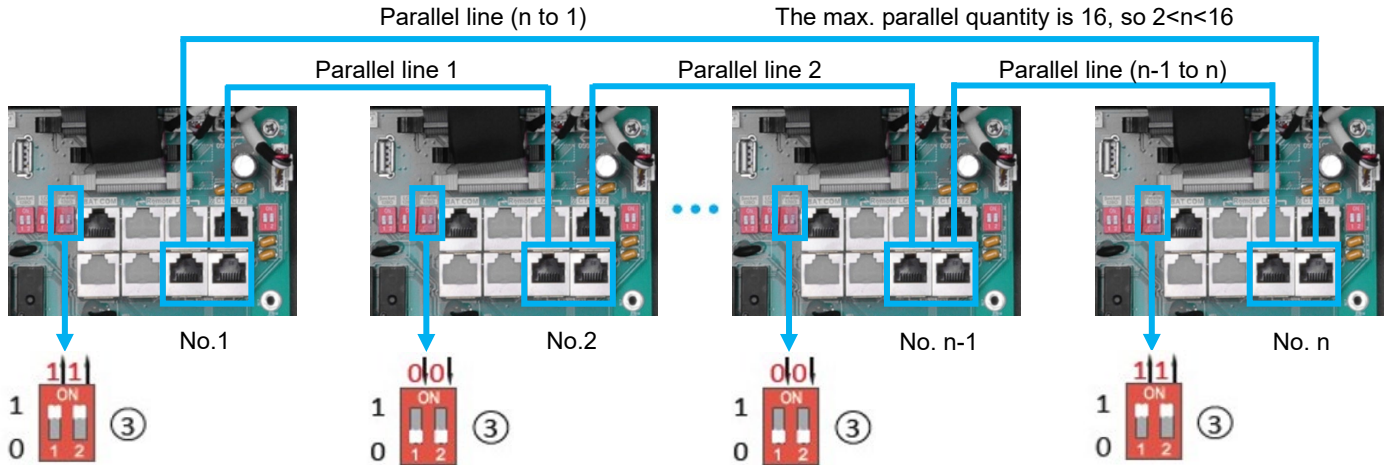

If needed, contact the inverter supplier for more detailed guidance on paralleling the system.



REMINDER:

If the inverter-to-inverter paralleling cable needs to be extended, ensure the cable is a straight-through CAT5 or higher CAT-rated cable. See image below for reference.

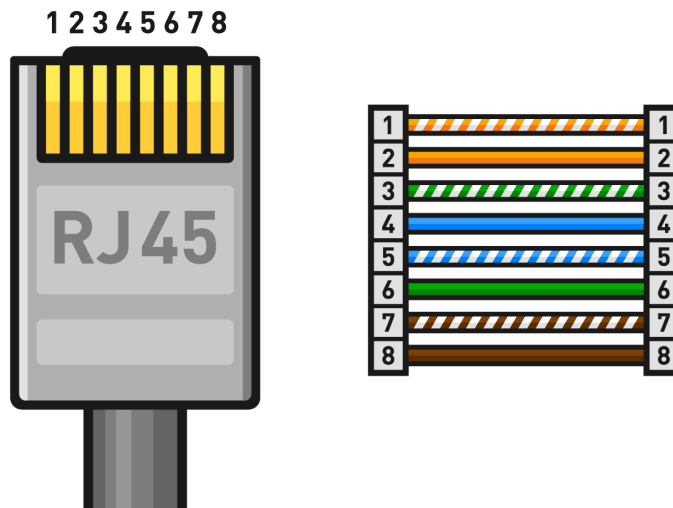

Parallel Configuration:

1. Before commissioning the system, verify that all inverters are updated to the latest firmware. Visit www.eg4electronics.com for the latest firmware version.
2. Make sure the power cables and parallel communication cables have been wired correctly and verify the DIP switch configurations are correct.
3. Power on the inverters.
4. Login to the Monitor Center Website or the EG4® Electronics app. See section 10 for more information on how to access these and detailed information on how to use the app and website.
5. Ensure all dongles are on one station, contact the installer or distributor for more information.

Commissioning Steps via the Monitor Center Website:

1. On the Monitor Center website, select which unit to set as the “Master” in the drop-down menu at the top of the page.
2. Select “Maintenance” and scroll to “Application Setting.”
3. Select “1 Phase” or “3 Phase Master” under “Set System Type” (a three-phase system must have three or more inverters).
4. Select “U Phase” under “Set Composed Phase.”
5. Enable “Share Battery.”
6. Enable “Parallel Setting Data Sync.”
7. On all other inverters, select “Slave” under “Set System Type” and repeat steps 4 through 6 for single phase systems. Continue to the Finish Commissioning Steps below.
8. For three phase systems, the phasing will be set to “U Phase” for the master, “V Phase” for the first slave, and “W Phase” for the next. The pattern will repeat for each subsequent inverter, restarting at “U Phase.” See Finish Commissioning Steps below:

The screenshot displays the EG4 Electronics Monitor Center Website interface. The top navigation bar includes icons for Monitor, Data, Configuration, Overview, and Maintenance (highlighted with a blue box). Below the navigation bar, there is a dropdown menu labeled "Select station first" with a "Read" button. The main content area is titled "Application Setting" and contains various configuration options:

- No Batteries (?): Enable / Disable
- Power Backup (?): Enable / Disable
- Grid Sell Back (?): Enable / Disable
- Fast Zero Export (?): Enable / Disable
- PV Arc (?): Enable / Disable
- Grid Loss Warning Clear (?): Enable / Disable
- Normal / Standby (?): Normal / Standby
- Micro-Grid (?): Enable / Disable
- System Charge SOC Limit(%): [10, 101] Set
- Seamless EPS switching (?): Enable / Disable
- Grid Sell Back Power(kW) (?): [0, 25.5]
- Off-Grid Mode (?): Enable / Disable
- PV Arc Fault Clear (?): Clear
- RSD (?): Enable / Disable
- Restart Inverter (?): Restart
- Max. AC Input Power(kW) (?): [0, 6553.5]
- System Charge Volt Limit(V): [40, 59.5]

The "Parallel System" section at the bottom is highlighted with a blue box and includes:

- Set System Type (?): <Empty> Set
- Set Composed Phase (?): <Empty> <Empty> Set
- Share Battery (?): Enable / Disable
- Parallel Setting Data Sync (?): Enable / Disable

Commissioning Steps via the EG4® App:

1. On the EG4® Electronics App, select the “Setting” icon.
2. At the top, select the device to set as the “Master” in the drop-down menu.
3. Toggle the “Standby/Normal” setting off.
4. Select “Application Setting.”
5. Select “System Type” and set to either “1 Phase Master” or “3 Phase Master” (three phase must have three or more inverters).
6. Select “Composed Phase” and set to “U Phase.”
7. Toggle “Share Battery” on.
8. Select the inverters to set to “Slave” in the top drop-down menu and select “Slave” in “System Type” setting. Repeat steps 6 and 7 for single phase systems. Once finished with all inverters, continue to the Finish Commissioning Steps below.
9. For three phase systems, the phasing will be set to “U Phase” for the master, “V Phase” for the first slave, and “W Phase” for the next. The pattern will repeat for each subsequent inverter, restarting at “U Phase.” See Finish Commissioning Steps below:

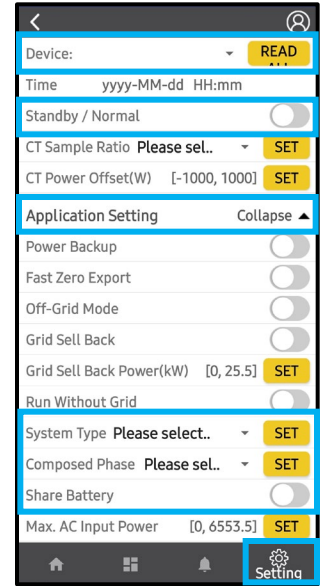

Finish Commissioning Steps:

1. Turn on the battery and make sure the communication works on all units.
2. Check the parallel info via the app or website.
3. Enable “Power Backup” under “Application Setting.”
4. Before connecting loads to the load output terminal, check the output of L1 and L2, and L1 and N with a multimeter.
5. Add small loads to the load output and verify power output.
6. Finish the commissioning by switching all inverters from “Standby” to “Normal.”

7.8 GRID, LOAD, AND AC INFORMATION

This inverter can be used in 120/240V or 120/208V. The default setting is 120/240V. This inverter has passed the main grid connection regulations in the United States. Users can choose the different grid types and regulations in the “Grid Connect Setting,” on either the app or the website. On the website, this setting can be found under the Maintenance tab. On the app, this setting can be found under the “Setting” icon at the bottom of the page. For more information on the app and website, see section 10.

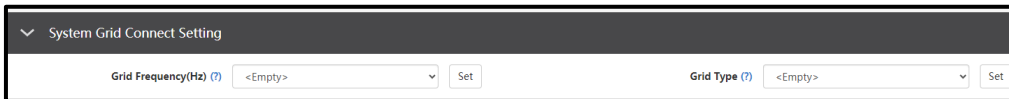
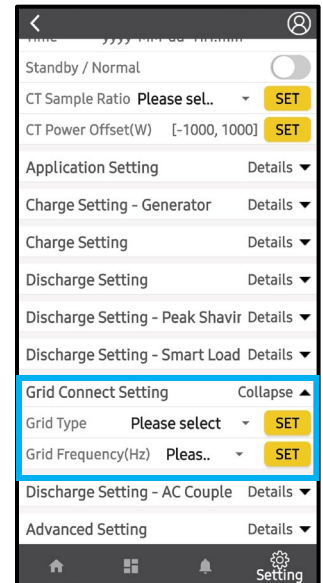

7.9 RAPID SHUTDOWN/ESS DISCONNECT

The inverter includes a rapid shutdown system with built-in RSD transmitter and RSD/ESS disconnect initiator.

In case of emergency, press the rapid shutdown button to cut off the power supply, cutting the inverter's AC output along with dropping the PV conductor's voltage to <30V in 30 seconds.



NOTE:

When using supported EG4® batteries in closed-loop communications with the inverter, the RSD also initiates ESS disconnect as required by NEC code.



External RSD

The system can utilize an External E-Stop Switch if the local AHJ deems it necessary.

- The external switch must have a normally closed contact type for emergency shutdown.
- The external switch should be connected to the RSD terminals on the inverter and mounted on a readily accessible location outdoors (check with the local AHJ for requirements).
- Remove jumper from external RSD connection and wire the E-Stop Switch into the RSD terminals according to the switch's specifications.

External RSD Wiring:

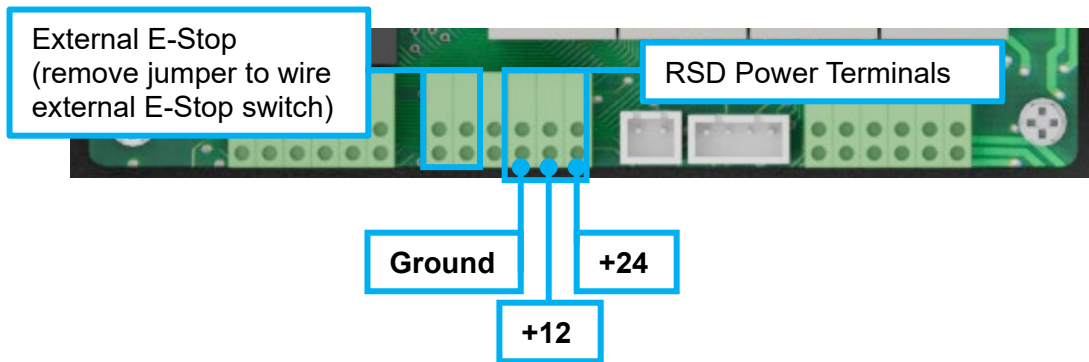

8. INVERTER START-UP AND SHUTDOWN PROCEDURE

Starting up the inverter

1. If using an external DC breaker between the battery bank and the inverter, turn it on. If not, turn on the BAT breaker located in the cable box of the inverter and then power on the battery system one battery at a time.
2. Make sure the PV voltages of the strings are within operating parameters (over 140V). Turn on the PV isolator switches between the inverter and array, and then turn on the switch on the side of the inverter.
3. Make sure Steps 1 and 2 are running properly and then turn on the grid power breaker.
4. Power on the load breakers in the load panel.



DANGER:

Never disconnect the battery, PV, or AC input power under load. If there is an emergency and users must shutdown the inverter, use rapid shutdown or follow the steps outlined below.

Shutting down the inverter

1. Switch off the load breaker.
2. Turn off the grid breaker feeding the inverter.
3. Turn off the PV disconnect and then the battery breaker. Wait for the LED lights to go off.

9. WORKING WITH A GRIDBOSS

While the FlexBOSS21 is a hybrid inverter that is capable of functioning on its own, pairing it with the EG4® GridBOSS allows for more flexibility and functionality.

FUNCTION	DESCRIPTION
AC Coupling	Allows the user to pair the FlexBOSS21 and GridBOSS with an existing solar system.
Smart Loads	Smart loads control devices that are powered on or off according to time of use and battery state of charge.
Generator Functions	Allows the user the option of a backup generator for when the grid is down and PV is insufficient to power loads.

When installing both GridBOSS and FlexBOSS21 together:

- Ensure the mounting wall is strong enough to bear the weight of all units.
- Maintain at least 150 mm of spacing between units.
- Observe all environmental specifications for all units.
- Check that the firmware is up to date, with the minimum firmware being 1D1D.
Note: *Once the firmware has been updated, it cannot be undone.*
- The Loads port will not be used on the FlexBOSS21.
- The CT clamps provided with the inverter will not be used as all input/output data will be tracked by GridBOSS.
- Ensure that all parallel inverters are configured before configuring GridBOSS.

For more information on GridBOSS and specific use cases, scan the following QR code:



GridBOSS
User Manual

10. MONITOR SYSTEM SETUP

There are multiple ways for the inverter to be programmed and monitored. The most common and convenient are the EG4® Monitor Center Website (monitor.eg4electronics.com) and the EG4® Monitor App. The following sections discuss the various ways to communicate with the inverter.



Monitor Center
Website



Monitor Center
Overview



Monitor App
for Android



Monitor App
for Apple

10.1 WI-FI/4G DONGLE CONNECTION

A Wi-Fi/4G dongle is used to monitor the inverter and remotely view the monitoring data on a computer or mobile device. Attach this module by plugging it in to the side of the inverter and securing it with the four (4) Phillips head screws.



For Wi-Fi Dongle troubleshooting, scan the following QR code:



Dongle
Troubleshooting Guide

10.2 ONLINE MONITORING SYSTEM USER INTERFACE



NOTE:

The monitoring system may change due to updates. Therefore, UI descriptions may vary from the current pages on the site. If you have any questions, or to create distributor or installer accounts, contact support@eg4electronics.com for assistance.

After connecting the Wi-Fi dongle, create an account by registering at monitor.eg4electronics.com. For more information on Monitor Center and the settings that can be adjusted there, scan the following QR code:



Monitor Center
Overview

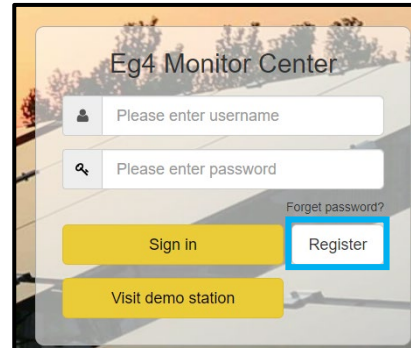

10.3 EG4® MONITOR APP SETUP

Register a monitoring account and set the Wi-Fi password for the Wi-Fi dongle by following the steps below before using EG4's monitoring system.

1. Register an account:

Visit monitor.eg4electronics.com or download the EG4® Monitor app to register for an end user account. Contact support@eg4electronics.com for distributor or installer accounts.

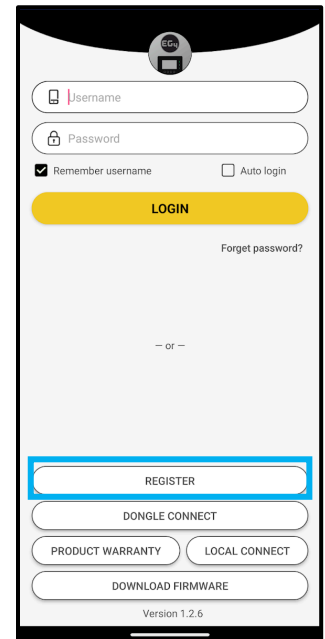

2. **When registering the account, provide the following information:**

Select the box to scan the QR code on the dongle shell to automatically input the information.

- a. Customer code: Contact the distributor or installer to obtain this code.
- b. Dongle SN: The serial number is attached to the dongle shell.
- c. Dongle PIN: PIN is attached to the dongle shell below the SN.

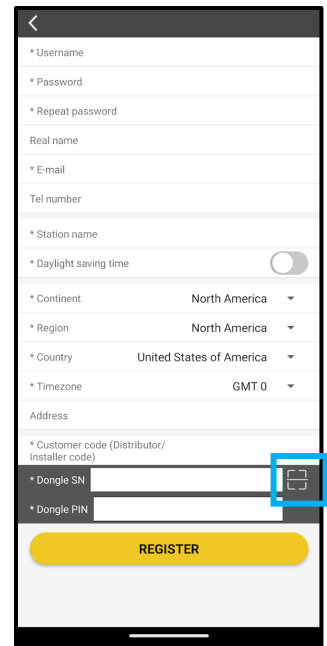

3. **Set the Wi-Fi password:**

- a. Plug in the Wi-Fi dongle and power on the inverter.
- b. Wait until the INV LED on the Wi-Fi module is solid on, then connect a mobile device to the dongle's Wi-Fi hotspot. The hotspot name is the same as the Wi-Fi dongle serial number.
- c. Open the app. Select the "DONGLE CONNECT."
- d. Select the yellow refresh button to display a list of available networks. Select the desired wireless network name and enter password.
- e. After selecting "HomeWifi Connect," the Wi-Fi dongle will reset. After the correct password is set, three lights will be solid on, which means the inverter is connected to the server. Disconnect the device from the dongle's hotspot and return to the login page and input username and password to begin monitoring the system.

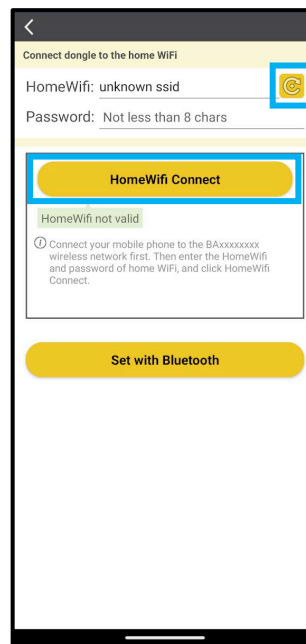
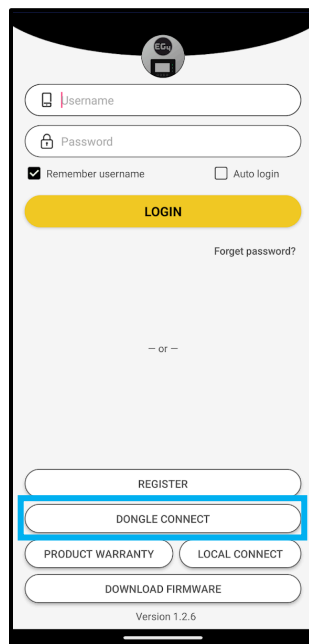

10.4 ENABLE APP NOTIFICATIONS

The EG4® Mobile App allows the end user to easily check real-time system information regarding the inverters, batteries, and other informative values.

Enable Notifications in Monitor Center:

1. Go to monitor.eg4electronics.com and login.
2. At the top of the screen, select “Configuration,” then “Users.”

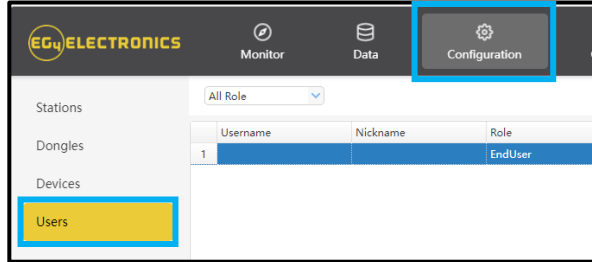

3. Select “User Management,” then “APP Notice.”

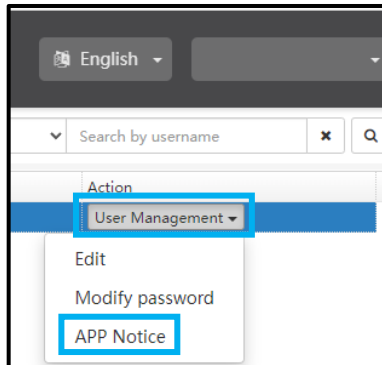

4. Choose which setting to enable, and what values will trigger a notification. Select “Edit.”

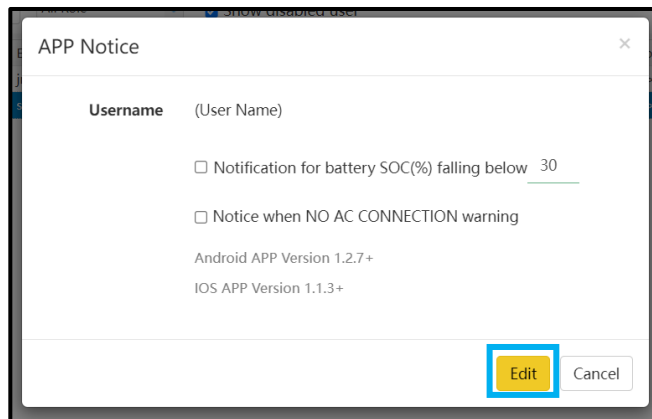

Enable Notifications on a Mobile Device:



NOTE:

Make sure the app is up to date before beginning!

1. Login to the EG4® Monitor App. Select the user icon at the top right corner of the screen.

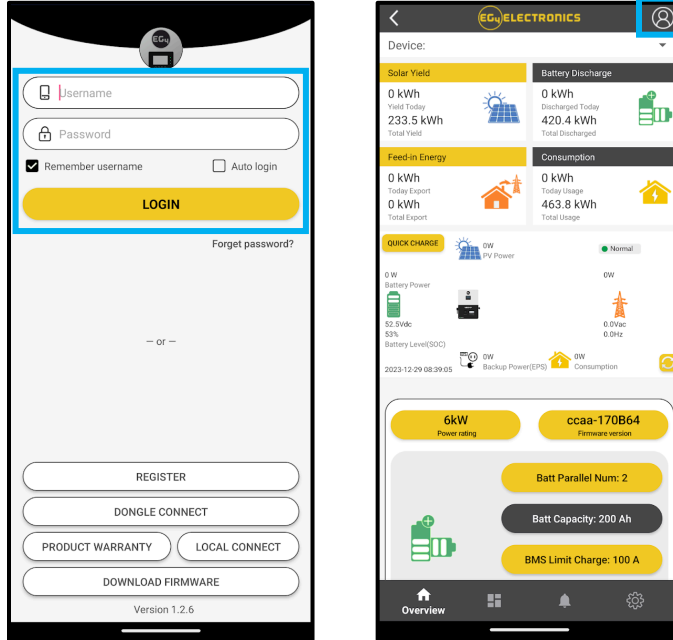

2. Select “Notifications,” “Allow Notifications,” and make selections for which notifications to receive. Toggle selection on to “Allow Notifications” on device and choose how to receive notifications.

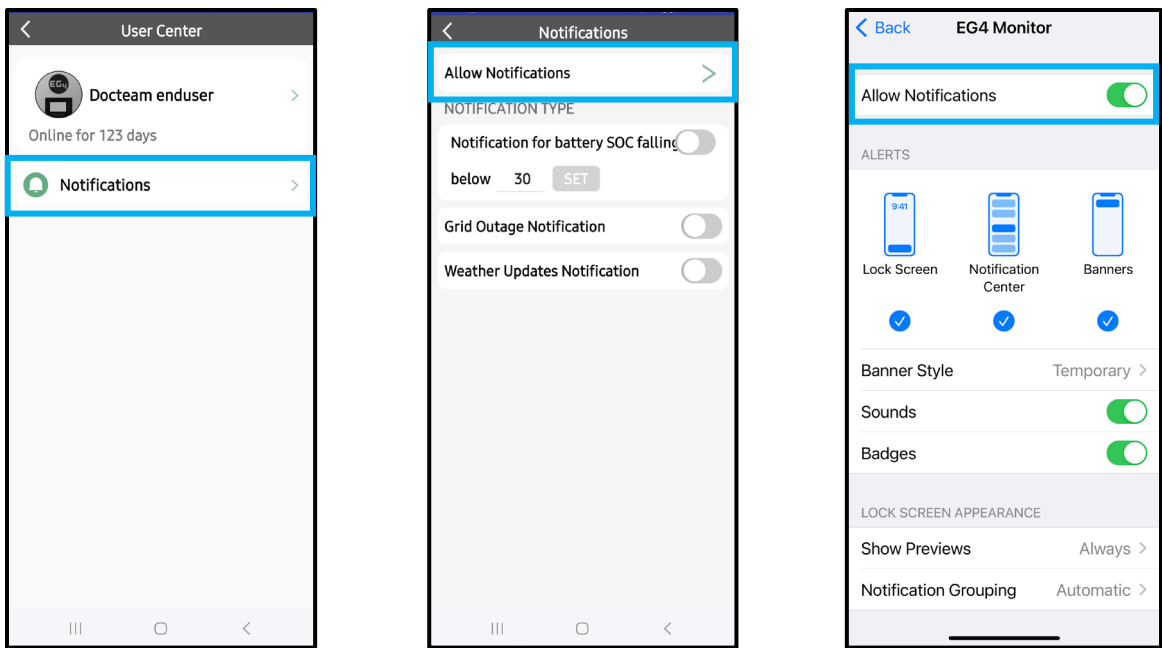

10.5 LOCAL MONITORING SETUP WITH THE EG4® MONITOR APP

If there is no Wi-Fi available at the location, use the local function to monitor or set up the system:

1. Download the EG4® Monitor app.
2. Connect the mobile device to the dongle's Wi-Fi hotspot after the INV LED on the Wi-Fi module is solid on. The name of the hotspot is the same as the serial number on the Wi-Fi module shell.
3. Select "Local Connect." Now the system can be monitored and set up either through the hotspot connection or Bluetooth (on Android devices only).

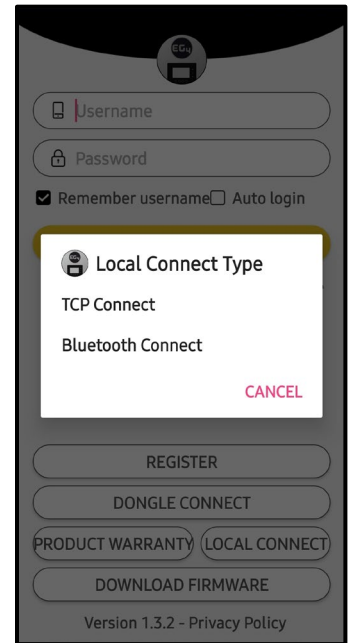

10.6 THIRD-PARTY RS485 COMMUNICATION

Meter 485B and 485A are used when the meter is not connected. These two pins can be used to communicate with the inverter using the RS485 Modbus protocol. Contact the distributor for the protocol for third party app development.

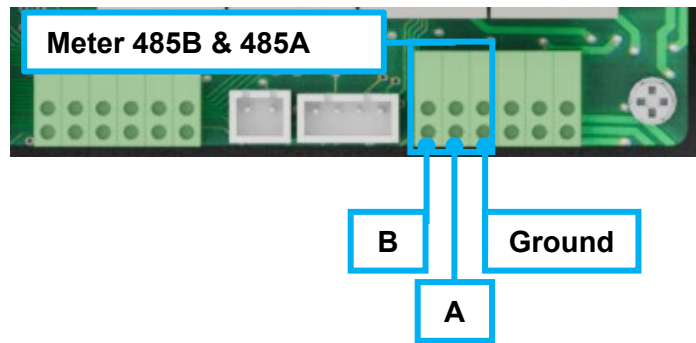

11. MONITOR CENTER SETTINGS



IMPORTANT:

These settings may need to be adjusted after installation. Consult with the installer/distributor before making any changes to avoid conflicting settings or damage to the system!

The following settings are found on the Monitor Center Website at monitor.eg4electronics.com under the Maintenance tab. For more information, scan the following QR code:



EG4 Monitor
Center Overview

11.1 COMMON SETTING

- **Time:** Set the time/date on the inverter. The input format is 2019-02-14 14:44:00 (YYYY-MM-DD HH:MM:SS).
- **PV Input Mode:** The connection type of solar modules.
- **Start PV Volt (V):** The voltage at which the inverter will begin utilizing PV.
- **Measurement:** Determines whether CTs or a Smart Meter are used to measure AC input.
- **Battery Type:** Choose the “Battery Type” and then select “Lithium Brand” (for closed-loop communications), or battery capacity for lead-acid/lithium batteries with no communications.
Note: After setting the battery type, all other battery settings will reset to default.
- **Lithium Brand:** This setting allows the user to select from a list of compatible batteries for closed-loop communications.
- **Firmware version:** The current firmware version installed on the inverter.
- **LCD Version:** Reserved for future use.

11.2 APPLICATION SETTING

The screenshot displays the 'Application Setting' interface with the following controls:

- No Batteries** (Enable/Disable)
- Power Backup** (Enable/Disable)
- Grid Sell Back** (Enable/Disable)
- Fast Zero Export** (Enable/Disable)
- PV Arc** (Enable/Disable)
- Grid Loss Warning Clear** (Enable/Disable)
- Normal / Standby** (Normal/Standby)
- Micro-Grid** (Enable/Disable)
- System Charge SOC Limit(%)** (Input: [10, 101], Set)
- Seamless EPS switching** (Enable/Disable)
- Grid Sell Back Power(kW)** (Input: [0, 25.5], Set)
- Off-Grid Mode** (Enable/Disable)
- PV Arc Fault Clear** (Clear)
- RSD** (Enable/Disable)
- Restart Inverter** (Restart)
- Max. AC Input Power(kW)** (Input: [0, 6553.5], Set)
- System Charge Volt Limit(V)** (Input: [40, 59.5], Set)
- Parallel System**
 - Set System Type** (Dropdown: <Empty>, Set)
 - Share Battery** (Enable/Disable)
 - Set Composed Phase** (Dropdowns: <Empty>, <Empty>, Set)
 - Parallel Setting Data Sync** (Enable/Disable)

- **No Batteries:** Allows access to off-grid mode when there is no battery and solar is the only input available.
- **Power Backup:** If Power Backup function is Enabled, the LOAD terminal will maintain output when AC is interrupted. Set “Power Backup” via web/app (When enabling this mode, LOAD output will be uninterrupted).
- **Seamless EPS switching:** When power is interrupted, the inverter will turn to EPS mode seamlessly unless there is a grid voltage fluctuation issue; in which case, we suggest you set to “Disable” to avoid misjudgment.
- **Grid Sell Back:** In some cases, the customer cannot feed energy into the grid. If the customer does not want to/cannot feed energy to the grid, disable the Grid Sell Back function.
- **Grid Sell Back Power(kW):** If Grid Sell Back function is enabled, adjust the power limitation to feed into the grid.
- **Fast Zero Export:** Normally, the inverter will adjust output power every 5 seconds to avoid export. If Fast Zero Export is enabled, the inverter will adjust output power accordingly.
- **Off-Grid Mode:** Allows for absolute zero-export, when there is an AC connection. When enabled, the battery discharges power to load first and the grid will not assist in powering loads and the batteries will not charge from AC unless “AC charge” is enabled.
- **PV Arc:** The inverter will detect when there is a PV input Arc Fault and protect the inverter from an Arc Fault.
- **PV Arc Fault Clear:** Clears the records of PV Arc Fault.
- **Grid Loss Warning Clear:** Enable for an absolute off-grid system. The “No AC Connection” and “AC V/F out of range” warnings will not occur when enabled.
- **RSD:** Enable or disable the rapid shutdown function of the PV inputs to remotely shut down the system.
- **Normal/Standby:** When set to Standby, there is no feed in, charge, nor discharge. Inverter will need to be in Standby mode when you are changing most settings such as paralleling the system. If this grid is available, the grid bypass relay will close, and the grid will take the load normally (this setting is found above Application Setting on the app).

- **Restart Inverter:** Turns the inverter off and back on.
- **Micro-Grid:** Only set this when generator is connected to the inverter’s grid terminal. With this setting enabled, the inverter will use AC power to charge the battery and will not export power.
- **Max. AC Input Power(kW):** The maximum amount of power to be imported from the grid; battery charging power will be adjusted based on load consumption and grid import limitation.
- **System Charge SOC/Volt Limit:** Set charge limits based on SOC or Voltage.

Parallel Settings

- **Set System Type:** The EG4® FlexBoss21 supports paralleling of multiple inverters; in this scenario, set one of the inverters to master and the others to slave. If all inverters are installed in one phase, set one of the inverters to “1 Phase Master”. To compose a three-phase system, set one of the inverters to “3 Phase Master”. All inverters are set to slaves by default, upon set up, set one inverter to master.
- **Set Composed Phase:** When using ≥ 3 inverters to compose a three-phase system, connect the AC terminals of the inverter to three-phase grids. If there is grid access in the system, the inverter will detect the phase it connects to automatically and record it. Next time, it will output the phase it detected. If the user setting is different from the phase inverter detected, it will output the phase detected. The output phase record must be cleared manually. If there is no grid input, the inverter will use the user output phase setting to compose three-phase output. If the customer sets the wrong phase (i.e., 2 U phase and no W phase) the system will report an error.
- **Share Battery:** For paralleled systems: if all inverters connect to same battery bank, Share Battery must be enabled. The master inverter will broadcast the battery info to all other inverters.
- **Parallel Setting Data Sync:** Syncs master inverter with all paralleled inverters.

11.3 SYSTEM GRID CONNECT SETTING

The screenshot shows a user interface for 'System Grid Connect Setting'. It contains two configuration fields, each with a dropdown menu and a 'Set' button. The first field is 'Grid Frequency(Hz) (?)' with a dropdown menu currently showing '<Empty>'. The second field is 'Grid Type (?)' also with a dropdown menu showing '<Empty>'. The interface has a dark header bar with a downward arrow and the text 'System Grid Connect Setting'.

- **Grid Frequency:** Selects the frequency of the grid. 60 Hz is the default.
- **Grid Type:** Select the correct grid type to function. 120/240V is the default.

11.4 CHARGE SETTING

The screenshot shows the 'Charge Setting' interface with the following fields and controls:

- Batt Charge Control:** Volt/SOC, Charge Last (Enable/Disable), Battery Backup Mode (Enable/Disable), Charge Current Limit (A) (0, 250) [Set].
- AC Charge:** AC Charge Enable (Enable/Disable), AC Charge Based On (<Empty> [Set]), AC Charge Power (kW) (0, 25.5) [Set], Start AC Charge SOC(%) (0, 90) [Set], Stop AC Charge SOC(%) (0, 100) [Set], Start AC Charge Volt(V) (40, 57) [Set], Stop AC Charge Volt(V) (42, 59) [Set], AC Charge Start Time 1 (0, 23] : [0, 59] [Set], AC Charge Start Time 2 (0, 23] : [0, 59] [Set], AC Charge Start Time 3 (0, 23] : [0, 59] [Set], AC Charge End Time 1 (0, 23] : [0, 59] [Set], AC Charge End Time 2 (0, 23] : [0, 59] [Set], AC Charge End Time 3 (0, 23] : [0, 59] [Set].
- Battery Backup Mode:** PV Charge Priority (Enable/Disable), PV Charge Power (kW) (0, 25.5) [Set], PV Charge Priority Stop SOC(%) (0, 100) [Set], PV Charge Priority Stop Volt(V) (48, 59) [Set], Battery Priority Start Time 1 (0, 23] : [0, 59] [Set], Battery Priority Start Time 2 (0, 23] : [0, 59] [Set], Battery Priority Start Time 3 (0, 23] : [0, 59] [Set], Battery Priority End Time 1 (0, 23] : [0, 59] [Set], Battery Priority End Time 2 (0, 23] : [0, 59] [Set], Battery Priority End Time 3 (0, 23] : [0, 59] [Set].

- **Batt Charge Control (Volt/SOC):** Batt Charge Control will charge the battery bank according to Voltage/SOC depending on selection.
- **Charge Last:** Charges battery as a last priority.
- **Charge Current Limit (A):** Set the maximum battery charge current.
- **Battery Backup Mode:** Enable to access Battery Backup Mode settings below.

AC Charge:

- **AC Charge Enable:** Grid charge configuration. To use grid power to charge the battery bank, enable “AC Charge” and set up to three different time periods when AC charging can happen. Set “AC charge power (kW)” to limit grid charging power.
- **AC Charge Based On:** Set AC charging according to Time or Volt(V)/SOC(%).
- **AC Charge Power(kW):** The maximum charging power from grid.
- **Start AC Charge SOC(%)/Volt(V):** Percentage or voltage at which system will start charging batteries from grid.
- **Stop AC Charge SOC(%)/Volt(V):** Percentage or voltage at which system will stop charging batteries from grid.
- **AC Charge Start Time 1-3:** Start AC Charging according to timeframe.
- **AC Charge End Time 1-3:** Stop AC Charging according to timeframe.

Battery Backup Mode:

- **PV Charge Priority:** Enable this setting to prioritize solar for charging batteries.
- **PV Charge Power (kW):** The maximum charge power from PV.
- **PV Charge Priority Stop SOC(%)/Volt(V):** The inverter will stop charging the batteries if the battery SOC or voltage exceeds these limits.
- **Battery Priority Start Time 1-3:** Start time for PV Charge Priority setting.
- **Battery Priority End Time 1-3:** End time for PV Charge Priority setting.

11.5 DISCHARGE SETTING

Discharge Setting

Batt Discharge Control (?) Volt SOC

Discharge Current Limit(Adc) (?) [0, 12] Set

Start Discharge P_import(W) (?) [50, 1] Set

On-Grid Cut-Off SOC(%) (?) [0, 90] Set

Off-Grid Cut-Off SOC(%) (?) [0, 90] Set

On-Grid Cut-Off Volt(V) (?) [40, 56] Set

Off-Grid Cut-Off Volt(V) (?) [40, 56] Set

Forced Discharge

Forced Discharge Enable (?) Enable Disable

Forced Discharge Power(kW) (?) [0, 25.5] Set

Stop Discharge SOC(%) (?) [0, 100] Set

Stop Discharge Volt(V) [40, 56] Set

PV Sell To Grid(Comp. w/ NEM3.0) (?) Enable Disable

Forced Discharge Start Time 1 [0, 23] : [0, 59] Set

Forced Discharge Start Time 2 [0, 23] : [0, 59] Set

Forced Discharge Start Time 3 [0, 23] : [0, 59] Set

Forced Discharge End Time 1 [0, 23] : [0, 59] Set

Forced Discharge End Time 2 [0, 23] : [0, 59] Set

Forced Discharge End Time 3 [0, 23] : [0, 59] Set

Peak Shaving

Grid Peak-Shaving (?) Enable Disable

Grid Peak-Shaving Power 1(kW) (?) [0, 25.5] Set

Grid Peak-Shaving Power 2(kW) (?) [0, 25.5] Set

Start Peak-Shaving Volt 1(V) [40, 59] Set

Start Peak-Shaving Volt 2(V) [40, 59] Set

Start Peak-Shaving SOC 1(%) [0, 100] Set

Start Peak-Shaving SOC 2(%) [0, 100] Set

Peak Shaving Start Time 1 [0, 23] : [0, 59] Set

Peak Shaving Start Time 2 [0, 23] : [0, 59] Set

Peak Shaving End Time 1 [0, 23] : [0, 59] Set

Peak Shaving End Time 2 [0, 23] : [0, 59] Set

- **Batt Discharge Control:** If the inverter communicates with the lithium battery and is capable of closed-loop communication, select charge control according to “SOC.” When using lead-acid batteries or lithium batteries without communication, select charge control according to “VOLT.”



NOTE:

When using EG4[®] batteries with the FlexBOSS21 inverter, it is recommended to set the cut-off SOC to 20% to maintain the 80% Depth of Discharge (DOD).

- **Discharge Current Limit(Adc):** Sets the discharge limit for lead-acid batteries.
- **Start Discharge P_import(W):** When set to 100, the battery will begin to discharge power to take the loads when the imported power from the grid is higher than 100W.
- **On-Grid Discharge Cut-Off SOC(%) / Volt(V):** Select battery SOC/voltage rating at which battery bank can take over the load from the grid.
- **Off-Grid Discharge Cut-Off SOC(%) / Volt(V):** Select how low to drain battery bank before going on-grid and allowing battery bank to charge. *With EG4[®] batteries, do not allow this value to go below 20%.*

Forced Discharge

- **Forced Discharge Enable/Disable:** Enable the forced discharge function to discharge battery at a set time period; set both the discharge power and time period.
- **Forced Discharge Power(kW):** Forced discharge power limit.
- **Stop Discharge SOC(%) / Volt(V):** If Battery SOC/voltage is lower than this limit, the inverter will stop the forced discharging function. **Note:** *For EG4[®] batteries, this value should be ABOVE 20% of total battery capacity.*
- **PV Sell To Grid(Comp. w/NEM3.0):** Enable for only PV sell back.
- **Forced Discharge Start Time 1-3:** Start time for Forced Discharge.
- **Forced Discharge End Time 1-3:** End time for Forced Discharge.

Peak Shaving

- **Grid Peak-Shaving:** Peak-Shaving is used to avoid peak demand charges from the grid. Peak shaving can be accomplished by halting grid charging at specific times. For example, during periods of peak demand (i.e., high grid rates), or when the batteries are fully charged based on SOC/Voltage. See Section 10.1 for more information regarding Peak-Shaving settings.
- **Grid Peak-Shaving Power(kW):** Used to set the maximum power that the inverter can draw from the grid.
- **Start Peak-Shaving Volt/SOC 1(V):** The voltage or SOC at which Peak-Shaving starts.
- **Start Peak-Shaving Volt/SOC 2(V):** The voltage or SOC at which Peak-Shaving stops.
- **Peak-Shaving Start Time 1-2:** The time of day at which charging by the grid will be halted.
- **Peak-Shaving End Time 1-2:** The time of day at which charging by the grid will resume.
- **Reset:** Reset all settings to default.

12. WORKING MODES AND RELATED SETTINGS

Time of Use:

Used to maximize cost savings by flexibly adjusting the battery’s usage pattern, establishing a real-time connection with the grid, and providing live updates on current electricity prices. This enables the system to meet energy demands across different time periods, provide real-time system status, and provide detailed reports. This feature is customizable to individual needs and fluctuations in electricity prices.

Weather Optimize Function

The weather optimize function is used to collect real-time weather data. There are multiple operating modes to adapt to various scenarios:

- Charge Priority Mode prioritizes battery charging to ensure stable electricity usage, making it ideal for areas with unstable power supply.
- Self-Use Mode prioritizes self-generated solar power to meet household electricity demands, making it ideal for areas with high electricity prices.
- Forced Charge/Discharge Mode chooses to charge or discharge batteries based on electricity pricing, making it ideal for time-of-use pricing areas.
- Intelligent Charging Control automatically adjusts the state of charge to maximize the efficient use of solar energy based on real-time weather information.
- Stable Electricity Usage optimizes charging strategies based on weather conditions, ensuring the battery remains adequately charged for stable electricity consumption.

To enable this feature, select “Maintenance” at the top of the Monitor Center webpage. Select “Weather Optimization” to the left of the screen. Select the desired inverter and click the location button.

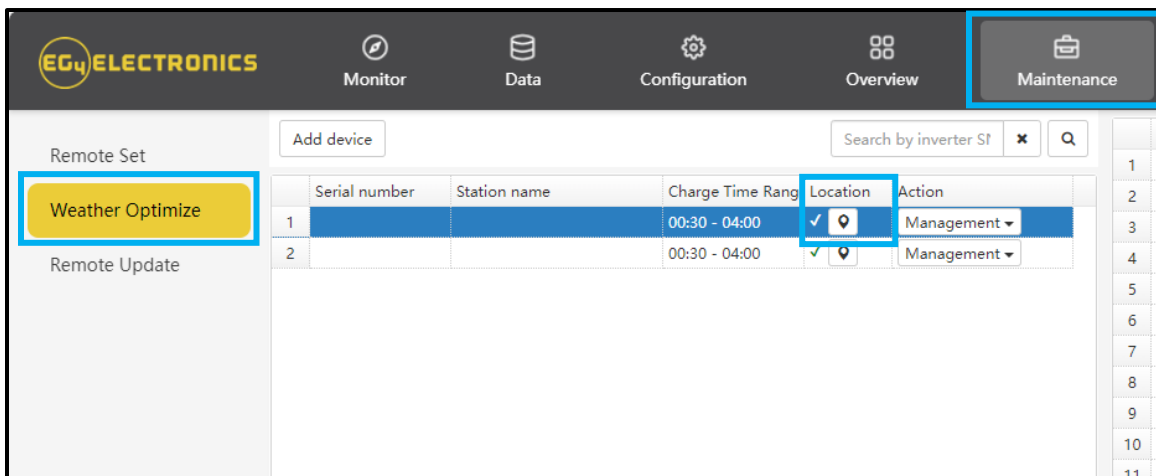

Input the inverter's information on the next screen and select update.

* Station name

LNG-LAT

* Create time

* Continent

* Region

* Country

* Timezone

* Daylight saving time Yes No

Afterwards, select “Management,” then “Edit.” Set charging times and percentages based on electricity use patterns and weather conditions. The platform sends user settings to the inverter, and the inverter provides feedback, confirming the receipt of setting and executing charging operations according to user-defined parameters.

* Serial number

* Charge Start Time

* Charge End Time

May not charge when end time is equal with start time

Charge percent(%) by weather:

* Clear sky

* Few(11%-25%) clouds

* Scattered(25%-50%) clouds

* Broken(51%-84%) clouds

* Overcast(85%-100%) clouds

* Light rain

* Moderate rain

* Heavy rain

* Other

Working Modes

Working modes are pre-set priority systems that allow users to configure the system to meet their demands through extensive customizations. These modes can be found under the Maintenance tab by clicking “Working Mode.” Scroll past “Application Setting” to the “Working Mode Setting” section.



Working Mode Definitions:

- **Backup Mode:** Used to save battery power as a last resort. The solar array powers the loads, and when PV is insufficient, loads will pull from the grid. The inverter will only power loads with battery when there are no other options.
- **Peak Shaving:** Used to avoid peak demand charges from the grid by using a combination of settings to limit the power drawn from the grid.
- **AC Charge Mode:** Used to charge batteries with grid power when electricity prices are cheap, and discharge battery power to supply load or export to the grid when electricity prices are high.
- **PV Charge Priority:** Used to charge battery bank with PV; once battery bank is charged, then PV will be used to power loads.
- **Forced Discharge/Export PV Only:** Used to sell PV and/or battery power back to the grid.
- **Self-Consumption:** Used to significantly lower grid consumption. Solar arrays power loads and, when PV is insufficient, batteries power loads; AC is only used as a last resort.

Backup Mode

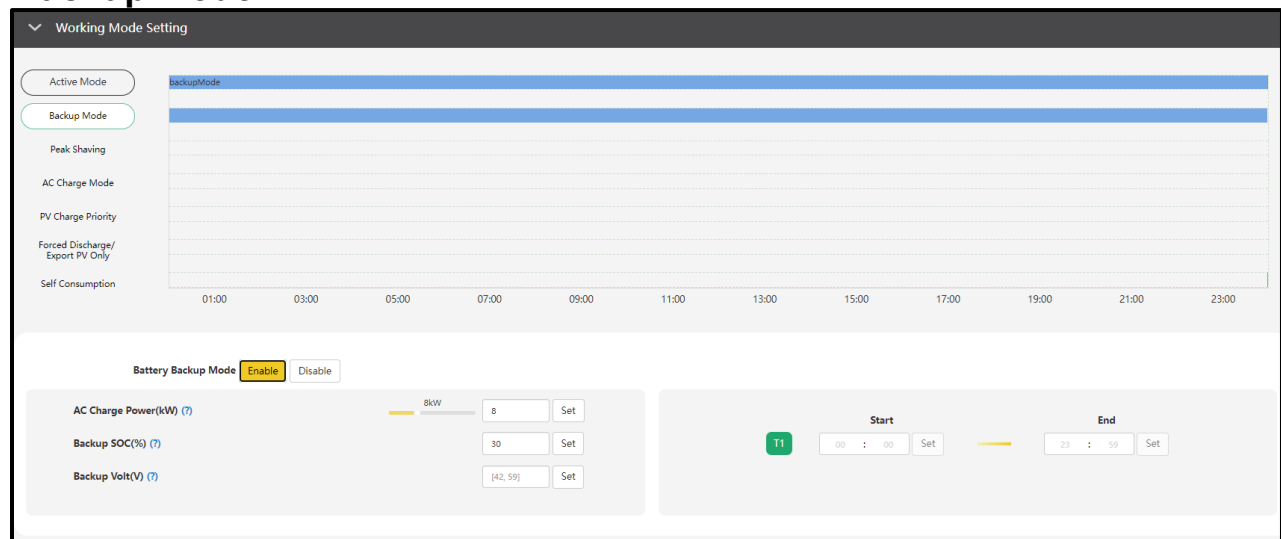

- **Battery Backup Mode:** When enabled, the system will use the batteries as a last resort during the set timeframes.
- **AC Charge Power (kW):** The maximum charging power from grid.
- **Backup SOC(%):** Set the maximum SOC for backup. This parameter is the same as Stop AC Charge SOC.
- **Backup Volt(V):** Set the maximum Voltage for backup. This parameter is the same as Stop AC Charge Volt.
- **Start/End Times:** Set times to begin and end Backup Mode.

Peak Shaving

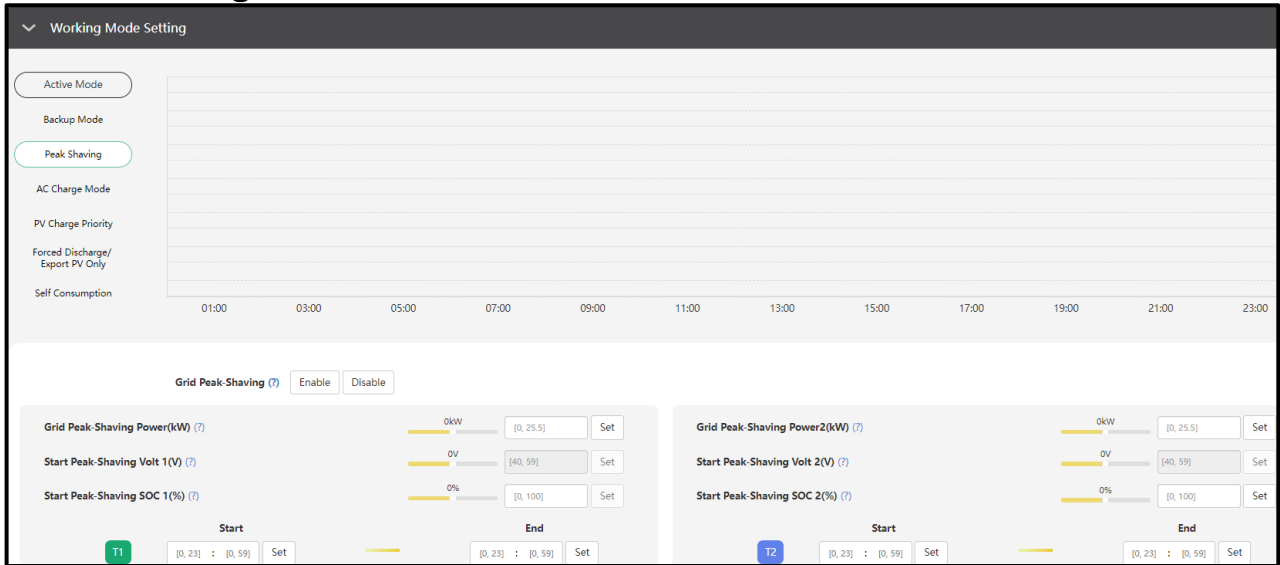

- **Grid Peak-Shaving:** Enable grid peak-shaving.
- **Grid Peak-Shaving Power(kW)/Grid Peak-Shaving Power2(kW):** Set the maximum amount of power that will be drawn from the grid.
- **Start Peak-Shaving Volt 1(V)/Start Peak-Shaving Volt 2(V):** Set the starting point of peak-shaving when using voltage setpoints for batteries.
- **Start Peak-Shaving SOC 1(%)/Start Peak-Shaving SOC 2(%):** Set the starting point of peak-shaving when using SOC setpoints for batteries.
- **T1/T2 Start/ End:** Set the start/ end time of peak-shaving depending on SOC/voltage as configured above.

AC Charge Mode

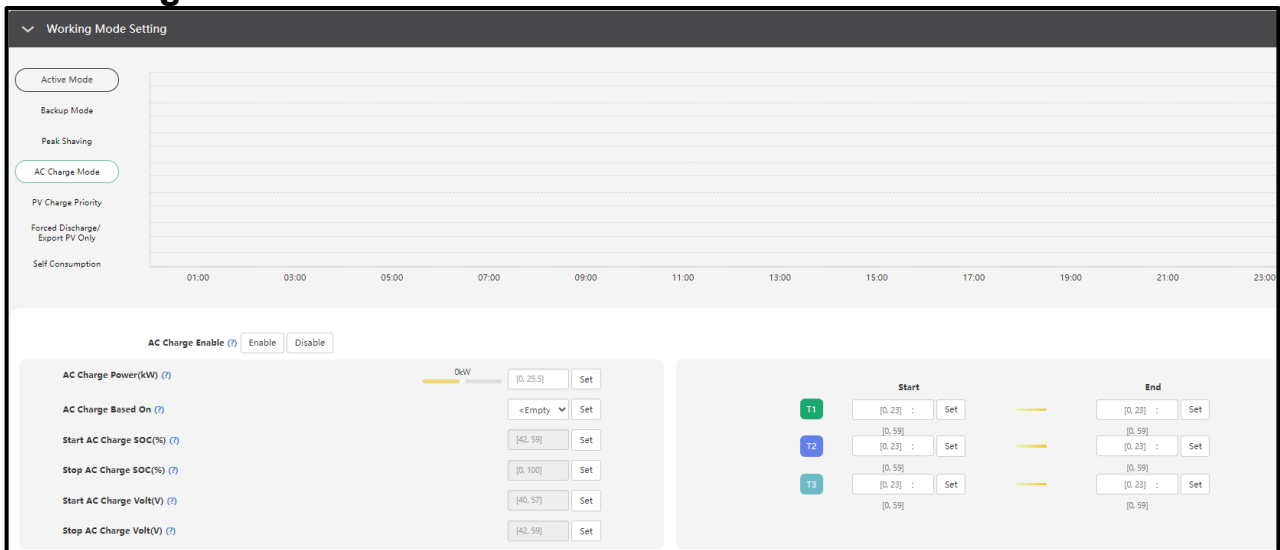

- **AC Charge Enable:** Enable the system's ability to charge batteries from the grid.
- **AC Charge Power(kW):** Set the maximum power drawn from the grid to charge batteries.
- **AC Charge Based On (SOC/Volt/Time):** Configure how the system will charge batteries from the grid by setting custom voltage points, SOC of batteries, or by time.

PV Charge Priority

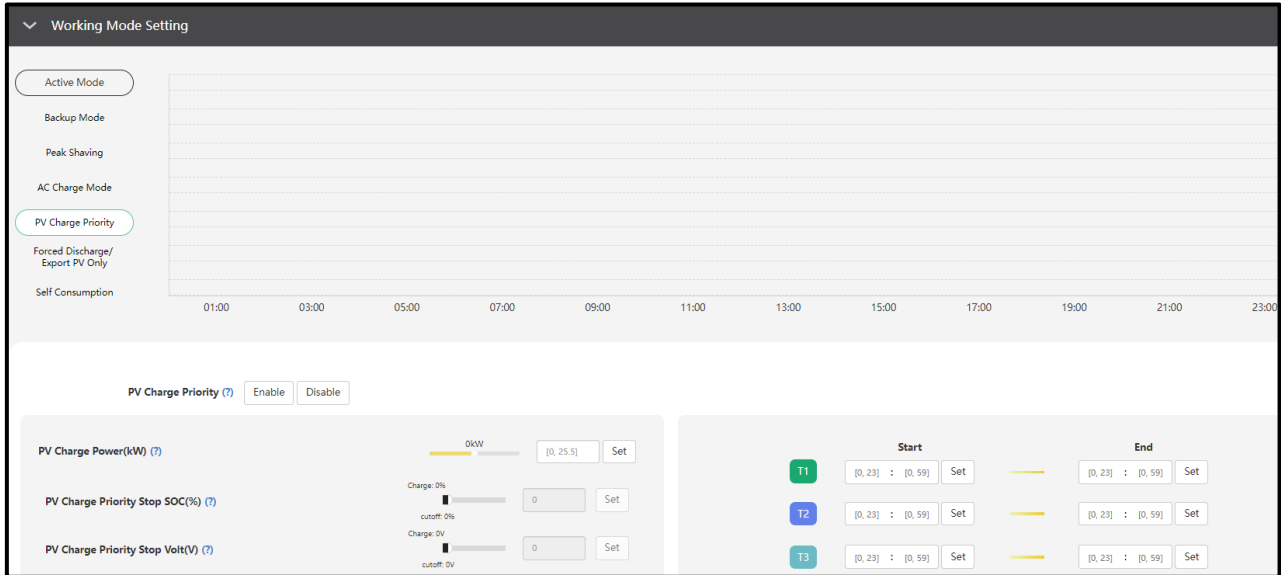

The order of priority for solar power usage will be Battery >Load >Grid. During the “PV Charge Priority” period, loads are first supplied power from the grid. If there is excess solar power after charging batteries, the excess solar will power the loads along with grid power.

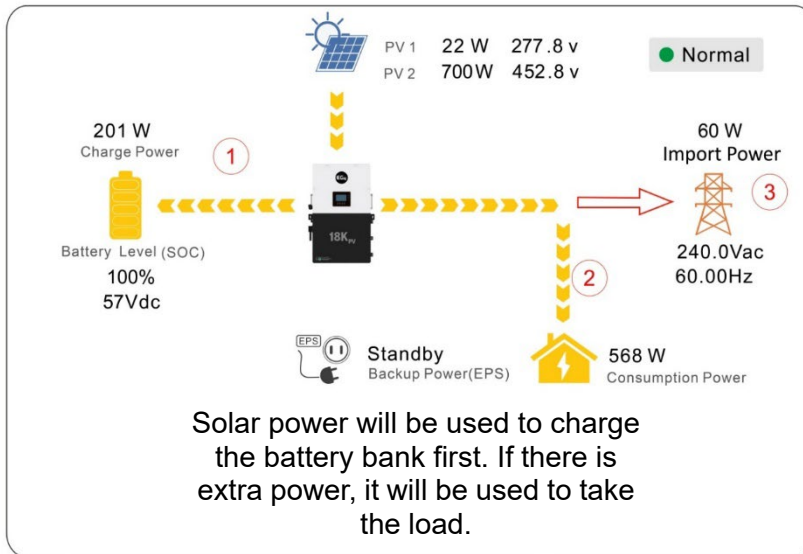

- **PV Charge Priority:** Enable the Battery Priority/PV Charge Priority working mode.
- **PV Charge Power(kW):** Set the maximum amount of power to charge the batteries from solar.
- **PV Charge Priority Stop SOC(%)/Volt:** Set the stop point for PV Charge Priority according to SOC or Voltage.
- **T1/T2/T3:** Set up to three different start and stop times for the PV Charge Priority working mode.

Forced Discharge/ Export PV Only

The screenshot shows the 'Working Mode Setting' interface. On the left, a sidebar lists various modes: Active Mode, Backup Mode, Peak Shaving, AC Charge Mode, PV Charge Priority, Forced Discharge/ Export PV Only (highlighted), and Self Consumption. The main area features a large empty grid with a time axis from 01:00 to 23:00. Below the grid, there are several configuration options:

- Forced Discharge Enable (?)**: Enable/Disable buttons.
- Export PV Only (?)**: Enable/Disable buttons.
- Forced Discharge Power(kW) (?)**: Input field with value [0, 25.5] and a Set button.
- Stop Discharge SOC(%) (?)**: Input field with value [0, 100] and a Set button.
- Stop Discharge Volt(V)**: Input field with value [40, 56] and a Set button.
- Time Scheduling Table:** A table with columns for Start and End times, and three rows for T1, T2, and T3. Each row has input fields for start and end times (e.g., [0, 23] : [0, 59]) and Set buttons.

- **Forced Discharge Enable:** Enable this setting to forcefully discharge the station's battery bank.
- **Export PV Only:** Enable this setting to sell back generated PV power to the grid.
- **Forced Discharge Power(kW):** Set the maximum power limit of battery discharge.
- **Stop Discharge SOC(%) / Volt:** Stop the forced discharge upon reaching the set SOC/ voltage point.
- **T1/T2/T3:** Set up to three different start and stop times for the Force Discharge/Export PV Only working mode.

Self Consumption

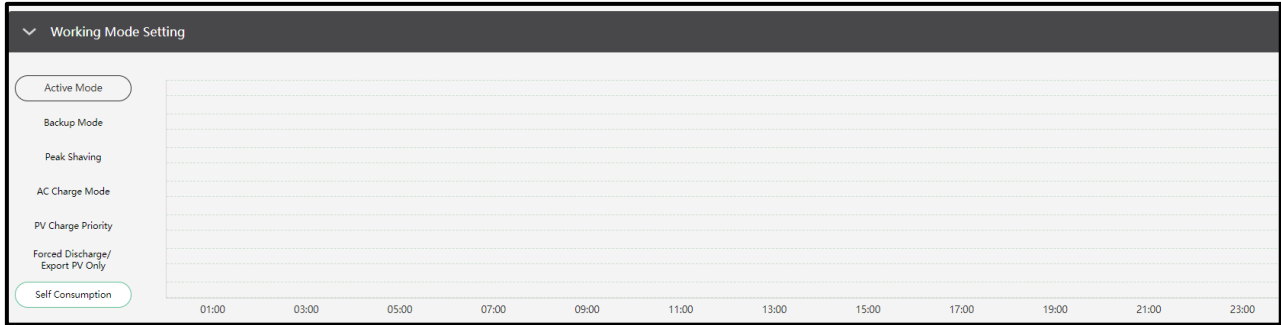

The station will default to Self Consumption mode. The order of priority for powering loads is Solar > Battery > Grid. The order priority for solar power is Load > Battery > Grid which creates an ideal scenario when needing to prioritize solar power generation over other types of power. Self Consumption mode will increase the self-consumption rate of solar power and reduce energy bills significantly. Effective when Charge Priority, AC Charge, and Forced Discharge are disabled.

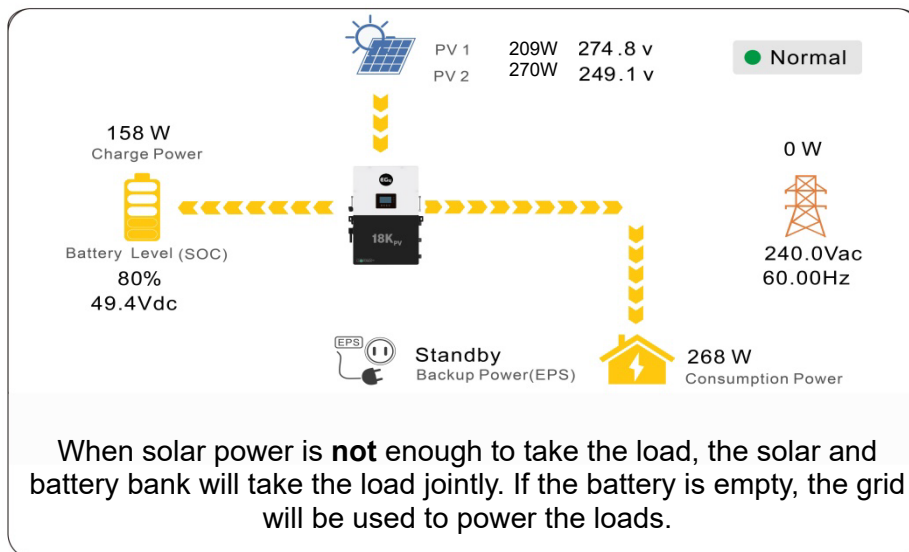
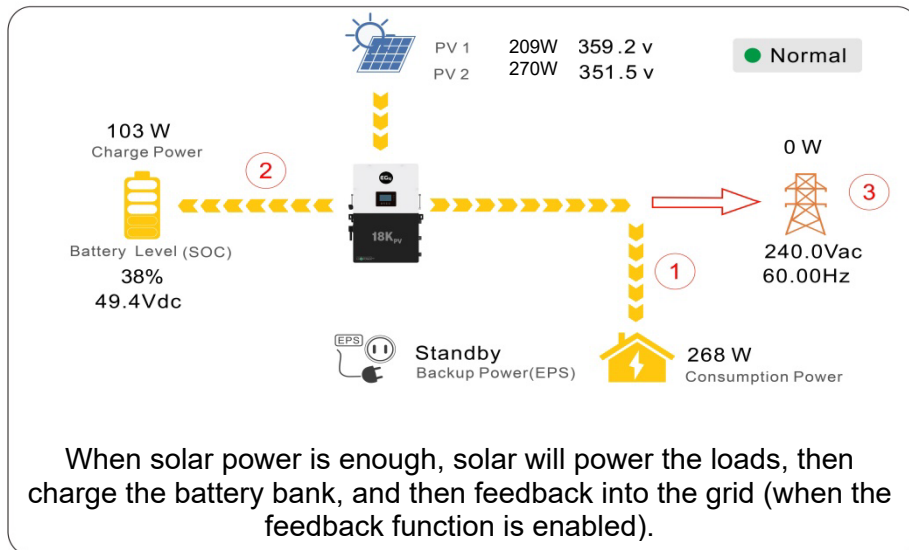

13. FIRMWARE UPDATES

13.1 FIRMWARE UPDATES VIA EG4® ELECTRONICS APP

Before updating firmware through the EG4® Monitor app, ensure the mobile device being used has enough battery life to last through the update. While the update is ongoing, do not close the application. Ensure the Wi-Fi dongle is securely connected and correctly configured (see section 10.1 for details) before performing the following steps:

1. Open the EG4® Electronics app on a mobile device and select the “DOWNLOAD FIRMWARE” button.
2. Choose the correct firmware file (see eg4electronics.com for the most up-to-date files) and select “DOWNLOAD” on the right side to download the file to the mobile device.
3. Keep the app running and go to the mobile device’s Wi-Fi settings. Connect the mobile device to the dongle’s Wi-Fi network. The dongle’s network ID will be the same as the dongle’s serial number.
4. Return to the home screen of the app and select “LOCAL CONNECT.” Select the “Set” button on the bottom right side and proceed to the next step.
5. After completing step 4, the Local Set Interface will appear. Swipe to the bottom of the screen and select “UPDATE FIRMWARE.”
6. Choose the correct installation package in the dropdown box and select “UPDATE FIRMWARE” to begin the updating process.

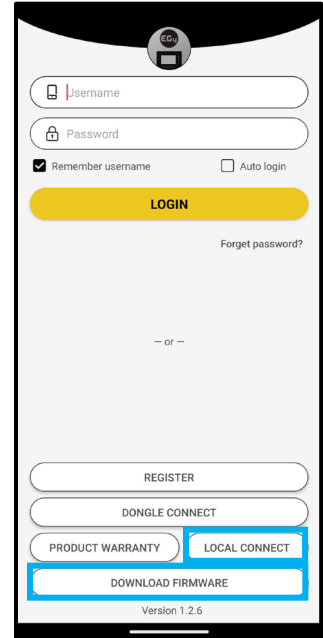

After selecting the “UPDATE FIRMWARE” button, the update will begin. Update progress can be viewed via the app. Once the update is completed, a notification will appear confirming that the firmware has been successfully updated. After successfully updating firmware, the inverter will restart itself. Make sure to update all inverters installed in the same ESS to the latest firmware version.

13.2 FIRMWARE UPDATE VIA MONITOR CENTER (WEBSITE)

1. Distributors and installers can update firmware by using the EG4® Electronics website monitoring system. Contact EG4® to make sure the files are correct.
2. Log in to the EG4® Electronics Monitor System. Select “Maintenance,” and then select “Remote Update.”
3. Choose the inverter to update and then select “Standard Update.” The Monitor Center will begin updating both firmware files in the inverter. The latest version of the firmware will be displayed in the bottom right window.

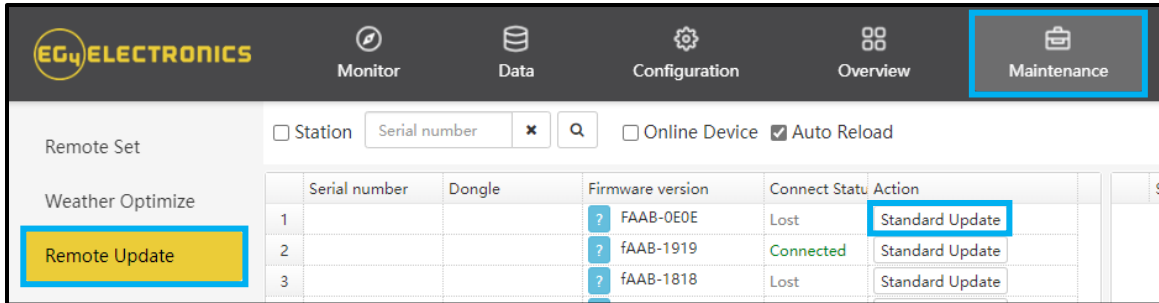

The screenshot shows the EG4 Electronics Monitor Center interface. The top navigation bar includes 'Monitor', 'Data', 'Configuration', 'Overview', and 'Maintenance' (highlighted with a blue box). Below the navigation bar, there are search filters for 'Station' (Serial number) and 'Online Device' (checked), along with an 'Auto Reload' checkbox. A 'Remote Update' button is highlighted with a yellow box. Below this, a table lists three inverters with their serial numbers, dongle IDs, firmware versions, and connection statuses. The 'Action' column for each inverter has a 'Standard Update' button highlighted with a blue box.

	Serial number	Dongle	Firmware version	Connect Status	Action
1			FAAB-0E0E	Lost	Standard Update
2			FAAB-1919	Connected	Standard Update
3			FAAB-1818	Lost	Standard Update



IMPORTANT:

Throughout the update, the inverter will automatically cycle power as it moves from one update to the next; however, if at any time an “Update Failed” alert appears, restart the full update from the first task. The “Update Failed” alert will only appear in the monitoring center. The software may need more than one attempt to update. If unable to successfully update the firmware, contact the distributor.



14. TROUBLESHOOTING AND MAINTENANCE

14.1 REGULAR MAINTENANCE

- Inspect the inverter every month to confirm nothing covers the inverter heat sink on the back of the inverter. If there is, shut down the inverter and clear the heat sink to restore proper cooling.
- Inspect the inverter every 3 months to verify if the operating parameters are normal and there is no abnormal heating or noise from all components in the system.
- Inspect the inverter every 6 months to check for any damaged cables, accessories, or terminals, and inspect the inverter itself.

14.2 LED DESCRIPTION

If a warning or fault occurs, users can troubleshoot according to the LED status description and the warning/fault information found in the “Event History” tab on the app or Monitor Center website.

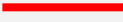
LED	DISPLAY	DESCRIPTION	ACTION
Green LED	Solid on 	Working normally	No action needed
	Flashing 	Firmware upgrading	Wait until the update is complete
Yellow LED	Solid on 	Warning, inverter may stop working	Needs troubleshooting
Red LED	Solid on 	Fault, inverter will stop working	Needs troubleshooting

Mobile App

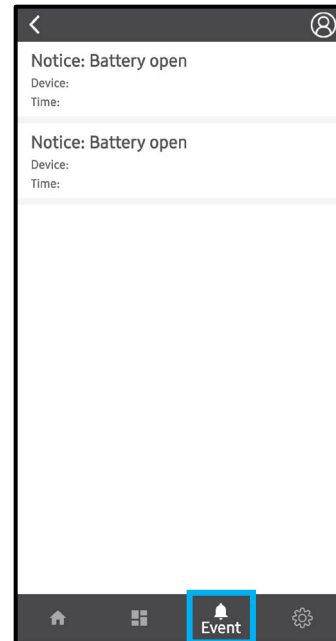
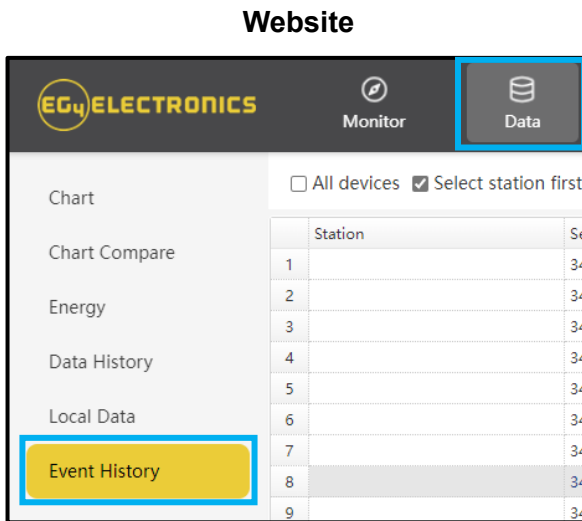

14.3 FAULTS AND ALARMS LIST

FAULT	MEANING	TROUBLESHOOTING
M3 Rx failure	M3 microprocessor fails to receive data from DSP	Restart the inverter. If the error persists, contact the supplier.
Model fault	Incorrect model value	
EPS short circuit	Inverter detected short-circuit on load output terminals	<ol style="list-style-type: none"> 1. Check if the L1, L2, and N wires are connected correctly at the inverter load output terminal. 2. Restart the inverter. If the fault persists, contact the supplier.
EPS power reversed	Inverter detected power flowing into load terminal	Restart the inverter. If the fault persists, contact the supplier.
Bus short circuit	DC Bus is short circuited	
Relay fault	Relay abnormal	
M8 Tx failure	DSP fails to receive data from M8 microprocessor	
M3 Tx failure	DSP fails to receive data from M3 microprocessor	

Vbus over range	DC Bus voltage too high	Ensure the PV string voltage is within the inverter specification. If string voltage is within range and this fault persists, contact the supplier.
EPS connect fault	Load terminal and grid terminal are wired incorrectly or reversed	Check if the wires on load terminal and grid terminal are wired correctly. If the fault persists, contact the supplier.
PV volt high	PV voltage is too high	Check if the PV string voltage is within the inverter specification. If string voltage is within range and this fault persists, contact the supplier.
Hard over curr	Hardware level over current protection triggered	Restart the inverter. If the fault persists, contact the supplier.
Neutral fault	Voltage between N and G is greater than 30V	Ensure the neutral wire is connected correctly.
PV short circuit	Short circuit detected on PV input	Disconnect all PV strings from the inverter. If the error persists, contact the supplier.
Temperature fault	Heat sink temperature too high	Install the inverter in a place with good ventilation and no direct sunlight. If the installation site is okay, check if the NTC connector inside the inverter is loose.
Bus sample fault	Inverter detected DC bus voltage lower than PV input voltage	Restart the inverter, if the fault persists, contact the supplier.
Inconsistent	Sampled grid voltage values of DSP and M8 microprocessors are inconsistent	
M8 Rx fault	M8 microprocessor fails to receive data from DSP	
Para Comm error	Parallel communication abnormal	<ol style="list-style-type: none"> 1. Check whether the connection of the parallel cable is loose. Connect the parallel cable correctly. 2. Ensure the PIN status of the CAN communication cable from the first to the end inverter is connected correctly.
Para master loss	No master in the parallel system	<ol style="list-style-type: none"> 1. If a master has been configured in the system, the fault will automatically be removed after the master works. 2. If a master has not been configured and there are only slaves in the system, set the master first. Note: For a single-unit system, the role of the inverter should be set as "1 Phase Master."

Para rating Diff	Rated power of parallel inverters are inconsistent	Confirm that the rated power of all inverters is the same.
Para Phase set error	Incorrect setting of phase in parallel	Confirm the wiring for the parallel system is correct. Once verified, connect each inverter to the grid. The system will automatically detect the phase sequence, and the fault automatically resolves after the phase sequence is detected. If the fault persists, contact the supplier.
Para sync loss	Parallel inverter fault	Restart the inverter. If the fault persists, contact the supplier.

ALARM	MEANING	TROUBLESHOOTING
Bat com failure	Inverter fails to communicate with battery	Check if the communication cable pinout is correct, and if the correct battery brand has been chosen. If all is correct but this alarm persists, contact the supplier.
AFCI com failure	Inverter fails to communicate with AFCI module	Restart the inverter. If the error persists, contact the supplier.
AFCI high	PV arc fault is detected	Check each PV string for correct open-circuit voltage and short-circuit current. If the PV strings are in good condition, clear the alarm.
Meter com failure	Inverter fails to communicate with the meter	Check if the communication cable is connected correctly and in good working condition. Restart the inverter. If the alarm persists, contact the supplier.
Bat Fault	Battery cannot charge or discharge	<ol style="list-style-type: none"> 1. Check the battery communication cable for correct pinout on both inverter and battery end. 2. Check if an incorrect battery brand has been chosen. 3. Check if there is a fault on the battery's indicator. If there is a fault, contact the battery supplier.
Fwm mismatch	Firmware version mismatch between the microprocessors	Attempt the firmware update again following the steps in section 13; if the fault persists, contact supplier.
Fan stuck	Cooling fan(s) are stuck	Contact supplier.
Trip by GFCI high	Inverter detected leakage current on AC side	<ol style="list-style-type: none"> 1. Check if there is ground fault on the grid and load side. 2. Restart the inverter. If the alarm persists, contact the supplier.
Trip by DCI high	Inverter detected high DC injection current on grid terminal	Restart the inverter. If the alarm persists, contact the supplier.
PV short circuit	Inverter detected a short circuit in PV input	<ol style="list-style-type: none"> 1. Check whether each PV string is connected correctly. 2. Restart the inverter. If the alarm persists, contact the supplier.
GFCI module fault	GFCI module is abnormal	Restart the inverter. If the alarm persists, contact the supplier.
Bat volt high	Battery voltage too high	Check whether the battery voltage exceeds 59.9V; battery voltage should be within inverter specification.

Bat volt low	Battery voltage too low	Check whether the battery voltage is under 40V; battery voltage should be within inverter specification.
Bat open	Battery is disconnected from inverter	Check the battery breaker or fuse. Reconnect as needed.
Off-grid overload	Overload on Load terminal	Check if load power on inverter LOAD terminal is within inverter specification.
Off-grid overvolt	Load voltage is too high	Load voltage is too high
Meter reversed	Meter connection is reversed	Check if the meter communication cable is connected correctly on the inverter and meter sides.
Off-grid dcv high	High DC voltage component on load output when running off-grid	Restart the inverter. If the alarm persists, contact the supplier.
RSD Active	Rapid shutdown activated	Check if the RSD switch is pressed.
Para phase loss	Phase losing in parallel system	Confirm that the wiring of the inverter is correct. If the master is set to 3-phase master, the number of parallel inverters must be ≥ 3 . (The grid input for each inverter should be connected correctly to grid L1, L2, L3.) If the master is set to 2x 208 master, the number of parallel inverters needs to be ≥ 2 . (And the grid input of each inverter should be connected correctly to grid L1, L2, L3.)
Para no BM set	Master is not set in the parallel system	Set one of the inverters in the parallel system as the master.
Para multi BM set	Multiple Primaries have been set in the parallel system	There are at least two inverters set as the master in the parallel system. Keep one master and set the other as slave.

15. STANDARDS AND CERTIFICATIONS

The EG4® FlexBOSS21 is cETL listed and complies with national and international standards for safety and reliability when connected to the grid.

Safety

- UL1741, SA, SB
- RSD NEC 2020:690.12 (PENDING)
- AFCI NEC 2020:690.11/UL1699B
- GFCI NEC 2020:690.41(B)
- CSA 22.2.107.1:2016 Ed. 4
- CSA 22.2.330:2017 Ed. 1

Grid Connection

- IEEE 1547.1:2020; IEEE 1547:2018
- Hawaii Rule 14H [HECO SRD IEEE 1547.1-2020 Ed. 2]
- California Rule 21 Phase I, II, III

EMC

- FCC Part 15 Class B (PENDING)

Outdoor Rating

- NEMA 4X

16. WARRANTY INFORMATION

For information regarding warranty registration on EG4® Electronics products, please navigate to <https://eg4electronics.com/warranty/> and select the corresponding product to begin the registration process.

17. CHANGELOG

11-12-24

- Published v1.1.2
- Updated wire sizing and torque tables in Section 7.5
- Updated Idle Consumption in Section 1

12-4-24

- Updated Warranty Information

13-31-24

- Modified FCC Part 15, Class B to show (pending) in spec sheet

14-16-24

- First revision of document completed



CONTACT US

support@eg4electronics.com

(903) 609-1988

www.eg4electronics.com