

EG4® LIFEPOWER4 24V V2 200Ah SERVER RACK

QUICK-START GUIDE



TABLE OF CONTENTS

1.	ABBREVIATIONS	1
2.	TECHNICAL SPECIFICATIONS	2
3.	BATTERY SAFETY	4
3.1	SAFETY INSTRUCTIONS.....	4
3.2	IMPORTANT SAFETY NOTIFICATIONS	4
4.	SÉCURITÉ DE LA BATTERIE.....	6
4.1	CONSIGNES DE SÉCURITÉ	6
4.2	NOTIFICATIONS DE SÉCURITÉ IMPORTANTES.....	6
5.	PACKING LIST	8
6.	EQUIPMENT STORAGE.....	8
7.	FRONT PANEL CALLOUTS	9
7.1	BATTERY DIAGRAM	9
7.2	LED INDICATOR STATUS & DEFINITION.....	10
8.	INSTALLING THE BATTERY	11
8.1	GENERAL INSTALLATION.....	11
8.2	REQUIREMENTS FOR INSTALLATION	11
8.3	TOOLS NEEDED FOR INSTALLATION.....	11
8.4	INSTALLATION IN EG4 BATTERY RACK	12
9.	BATTERY COMMUNICATIONS.....	14
9.1	COMMUNICATION CABLE PINOUT AND DIP SWITCH ID TABLES.....	14
9.2	MULTIPLE BATTERY PARALLEL INSTALL	16
10.	BMS TOOLS.....	17
10.1	INTRODUCTION TO THE BMS.....	17
10.2	BMS TOOLS INSTALLATION AND INTERFACING	17
11.	FIRMWARE UPDATES.....	18
12.	TROUBLESHOOTING, MAINTENANCE & DISPOSAL.....	18
12.1	BATTERY CHARGING	18
12.2	ALARM DESCRIPTION AND TROUBLESHOOTING.....	18
12.3	LONG TERM MAINTENANCE	20
12.4	BATTERY END OF LIFE	20
13.	WARRANTY INFORMATION.....	20
14.	CHANGELOG.....	21

1. ABBREVIATIONS

- AWG – American Wire Gauge
- A – Amps
- Ah – Amp hour(s)
- AC – Alternating Current
- AFCI – Arc-Fault Circuit Interrupter
- AHJ – Authority Having Jurisdiction
- kAIC – kilo-Amp Interrupting Capability
- ANSI – American National Standards Institute
- BAT – Battery
- BMS – Battery Management System
- COM – Communication
- CT – Current Transformer
- DC – Direct Current
- DIP – Dual In-line Package
- DOD – Depth of Discharge
- EG – Equipment Ground
- EGS – Equipment Grounding System
- EMC – Electromagnetic Compatibility
- EPS – Emergency Power System
- ESS – Energy Storage System
- E-Stop – Emergency Stop
- FCC – Federal Communication Commission
- GE – Grounding Electrode
- GEC – Grounding Electrode Conductor
- GFCI – Ground Fault Circuit Interrupter
- GFDI – Ground Fault Detector/Interrupter
- Imp – Maximum Power Point Current
- IEEE – Institute of Electrical and Electronic Engineers
- IP – Ingress Protection
- I_{sc} – Short-Circuit Current
- In-lbs. – Inch Pounds
- kW – Kilowatt
- kWh – Kilowatt-hour
- LCD – Liquid Crystal Display
- LFP – Lithium Iron Phosphate
- L1 – Line 1
- L2 – Line 2
- mm – Millimeters
- MPPT – Maximum Power Point Tracking
- mV – Millivolt
- N – Neutral
- NEC – National Electric Code
- NEMA – National Electrical Manufacturers Association
- NFPA – National Fire Prevention Association
- Nm – Newton Meters
- NOCT – Normal Operating Cell Temperature
- PC – Personal Computer
- PCB – Printed Circuit Board
- PE – Protective Earth
- PPE – Personal Protective Equipment
- PV – Photovoltaic
- RSD – Rapid Shut Down
- SCC – Standards Council of Canada
- SOC – State of Charge
- STC – Standard Testing Conditions
- UL – Underwriters Laboratories
- UPS – Uninterrupted Power Supply
- V – Volts
- VOC – Open-Circuit Voltage
- VMP – Voltage Maximum Power

2. TECHNICAL SPECIFICATIONS

MODULE OPERATING PARAMETERS			
PARAMETER	BMS	RECOMMENDED	
VOLTAGE	25.6V	-	
CAPACITY	200Ah	-	
CHARGING VOLTAGE (BULK/ABSORB)	28.0 ± 0.4V	-	
SOC CUTOFF	22.4V	20%*	
CHARGING CURRENT	200A (Max. continuous)	30A	
DISCHARGING CURRENT	200A (Max. continuous)	-	
MAXIMUM CONTINUOUS DISCHARGE RATE	5.12kW	-	
NAMEPLATE ENERGY CAPACITY	5.12kWh	-	
BMS PARAMETERS			
CHARGE	SPEC	DELAY	RECOVERY
CELL VOLTAGE PROTECTION	3.8V	1 sec	3.45V
MODULE VOLTAGE PROTECTION	30.0V	1 sec	27.6V
OVER CHARGING CURRENT 1	>220A	10 sec	-
OVER CHARGING CURRENT 2	≥250A	3 sec	-
TEMPERATURE PROTECTION	<23°F or >158°F <-5°C or >70°C	1 sec	>41°F or <140°F >5°C or <60°C
DISCHARGE			
CELL VOLTAGE PROTECTION	2.3V	1 sec	3.1V
MODULE VOLTAGE PROTECTION	22.4V	1 sec	24V
OVER DISCHARGING CURRENT 1	>220A	30 sec	60 sec
OVER DISCHARGING CURRENT 2	>300A	5 sec	60 sec
SHORT-CIRCUIT	>500A	<0.1 mS	-
TEMPERATURE PROTECTION	<-4°F or >167°F <-20°C or >75°C	1 sec	>14°F or <149°F >-10°C or <65°C
PCB TEMP PROTECTION	>221°F (>105°C)	1 sec	<176°F (<80°C)

*EG4 recommends this value be set no lower than 20% to maintain the recommended 80% depth of discharge.

GENERAL SPECIFICATIONS			
PARAMETER	SPEC	TYPE	CONDITION
CELL BALANCE	120mA	Passive Balance	Cell Voltage Difference >40mV
TEMPERATURE ACCURACY	3%	Cycle Measurement	Measuring Range 40°F – 212°F (-40°C – 100°C)
VOLTAGE ACCURACY	0.5%	Cycle Measurement	For Cells/Module
CURRENT ACCURACY	3%	Cycle Measurement	Measurement Range +/-200A
SOC	5%	-	Integral Calculation
POWER CONSUMPTION (SLEEP & OFF MODE)	<300uA	-	Storage/Transport/ Standby
POWER CONSUMPTION (OPERATING)	<20mA	-	Charging/Discharging
COMMUNICATION PORTS	RS485/CAN	-	Customizable
MAXIMUM MODULES IN SERIES			1
MAXIMUM MODULES IN PARALLEL			64
DIMENSION (H×W×D)			6.1×19×17.4 in. (155×442×470 mm)
WEIGHT			99.2 lbs. (45 kg)
ENVIRONMENTAL PARAMETERS			
CHARGING RANGE			32°F – 113°F (0°C – 45°C)
DISCHARGING RANGE			-4°F – 122°F (-20°C – 50°C)
STORAGE RANGE			-4°F – 122°F (-20°C – 50°C)
INGRESS PROTECTION			IP21

3. BATTERY SAFETY

3.1 SAFETY INSTRUCTIONS

Before any work begins, carefully read all safety instructions, and always observe them when working on or with the battery. The installation must follow all applicable national or local standards and regulations. Consult with the local AHJ to obtain the proper permits and permissions before installation.

Incorrect installation may cause:

- *Injury or death to the installer, operator or third party*
- *Damage to the battery or other attached equipment*

3.2 IMPORTANT SAFETY NOTIFICATIONS



DANGER: Hazardous Voltage Circuits!

There are various safety concerns that must be carefully observed before, during, and after the installation, as well as during future operation and maintenance. The following are important safety notifications for the installer and any end users of this product under normal operating conditions.

1. **Do not disassemble the battery.** Contact the distributor for any issues that need repair for more information and proper handling instructions. Incorrect servicing or re-assembly may result in a risk of electric shock or fire and void the warranty.
2. **Never short-circuit DC inputs.** Short-circuiting the battery may result in a risk of electric shock or fire and can lead to severe injury or death and/or permanent damage to the unit and/or any connected equipment.
3. **Use caution when working with metal tools on or around batteries and systems.** **Risk** of electrical arcs and/or short circuiting of equipment can lead to severe injury or death and equipment damage.
4. **Beware of high battery current.** Ensure that the battery module breakers and/or on/off switches are in the “open” or “off” position before installing or working on the battery. Use a voltmeter to confirm there is no voltage present to avoid electric shock.
5. **Do not make any connections or disconnections to the system while the batteries are operating.** Damage to system components or risk of electrical shock may occur if working with energized batteries.
6. Make sure the battery and rack are properly grounded.
7. An installer should make sure to be well protected by reasonable and professional insulative equipment [e.g., personal protective equipment (PPE)].
8. Before installing, operating, or maintaining the system, it is important to inspect all existing wiring to ensure it meets the appropriate specifications and conditions for use.
9. Ensure that the battery and system component connections are secure and proper to prevent damage or injuries caused by improper installation.



WARNING: TO REDUCE THE RISK OF INJURY, READ ALL INSTRUCTIONS!

All work on this product (system design, installation, operation, setting, configuration, and maintenance) must be carried out by qualified personnel. To reduce the risk of electric shock, do not perform any servicing other than those specified in the operating instructions unless qualified to do so.

1. Read all instructions before commencing installation. For electrical work, follow all local and national wiring standards, regulations, and these installation instructions. All wiring should be in accordance with the National Electrical Code (NEC), ANSI/NFPA 70.
2. The battery and system can connect with the utility grid only if the utility provider permits. Consult with the local AHJ before installing this product for any additional regulations and requirements for the area.
3. All warning labels and nameplates on this battery should be clearly visible and must not be removed or covered.
4. The installer should consider the safety of future users when choosing the battery's correct position and location as specified in this manual.
5. Keep children away from touching or misusing the battery and relevant systems.

The battery is designed to stop charging when reaching the low threshold of 32°F. If charging current is observed when the internal battery temperature is below 32°F, disconnect battery immediately and consult distributor.



WARNING!

Cancer and Reproductive Harm – See www.P65Warnings.ca.gov for more details.

DISCLAIMER

EG4 reserves the right to make changes to the material herein at any time without notice.

Please refer to www.eg4electronics.com for the most updated version of our manuals/spec sheets.

4. SÉCURITÉ DE LA BATTERIE

4.1 CONSIGNES DE SÉCURITÉ

Avant de commencer tout travail, lisez attentivement toutes les consignes de sécurité et respectez-les toujours lorsque vous travaillez sur ou avec la batterie. L'installation doit être conforme à toutes les normes et réglementations nationales ou locales applicables. Consultez l'autorité compétente locale et/ou le service public pour obtenir les permis et les autorisations appropriés avant l'installation.

Une installation incorrecte peut entraîner les effets suivants :

- Blessure ou décès de l'installateur, de l'exploitant ou d'un tiers
- Dommages à la batterie ou à tout autre équipement attaché

4.2 NOTIFICATIONS DE SÉCURITÉ IMPORTANTES



DANGER: Circuits à haute tension!

Il existe divers problèmes de sécurité qui doivent être soigneusement observés avant, pendant et après l'installation, ainsi que lors de l'utilisation et de la maintenance futures. Ce qui suit sont des notifications de sécurité importantes pour l'installateur et tout utilisateur final de ce produit dans des conditions de fonctionnement normales.

1. **Ne démontez pas la batterie.** Contactez le distributeur pour tout problème nécessitant une réparation pour plus d'informations et des instructions de manipulation appropriées. Un entretien ou un remontage incorrect peut entraîner un risque d'électrocution ou d'incendie et annuler la garantie.
2. **Ne court-circuitez jamais les entrées CC.** Un court-circuit de la batterie peut entraîner un risque d'électrocution ou d'incendie et peut entraîner des blessures graves ou la mort et/ou des dommages permanents à l'appareil et/ou à tout équipement connecté.
3. **Soyez prudent lorsque vous travaillez avec des outils métalliques sur ou à proximité des batteries et des systèmes.** Le risque d'arcs électriques et/ou de court-circuit de l'équipement peut entraîner des blessures graves ou la mort et des dommages à l'équipement.
4. **Attention au courant de batterie élevé.** Assurez-vous que les disjoncteurs du module de batterie et/ou les interrupteurs marche/arrêt sont en position « ouvert » ou « arrêt » avant d'installer ou de travailler sur la batterie. Utilisez un voltmètre pour confirmer qu'il n'y a pas de tension présente afin d'éviter les chocs électriques.
5. **N'effectuez aucune connexion ou déconnexion du système pendant que les batteries fonctionnent.** Des dommages aux composants du système ou un risque d'électrocution peuvent survenir si vous travaillez avec des batteries sous tension.
6. Assurez-vous que le banc de batteries est correctement mis à la terre.
7. Un installateur doit s'assurer d'être bien protégé par un équipement isolant raisonnable et professionnel [par exemple, un équipement de protection individuelle (EPI)].
8. Avant d'installer, d'utiliser ou d'entretenir le système, il est important d'inspecter tout le câblage existant pour s'assurer qu'il répond aux spécifications et aux conditions d'utilisation appropriées.
9. Assurez-vous que les connexions de la batterie et des composants du système sont sécurisées et appropriées pour éviter les dommages ou les blessures causés par une mauvaise installation.



AVERTISSEMENT : Pour réduire le risque de blessure, lisez toutes les instructions !

Tous les travaux sur ce produit (conception du système, installation, fonctionnement, réglage, configuration et maintenance) doivent être effectués par du personnel qualifié. Pour réduire le risque d'électrocution, n'effectuez aucun entretien autre que ceux spécifiés dans le mode d'emploi, à moins d'être qualifié pour le faire.

1. Lisez toutes les instructions avant de commencer l'installation. Pour les travaux électriques, suivez toutes les normes de câblage locales et nationales, les réglementations et ces instructions d'installation. Tout le câblage doit être conforme au Code national de l'électricité (NEC), ANSI/NFPA 70.
2. La batterie et le système ne peuvent se connecter au réseau public que si le fournisseur d'électricité l'autorise. Consultez l'AHJ local avant d'installer ce produit pour connaître les réglementations et exigences supplémentaires de la région.
3. Toutes les étiquettes d'avertissement et les plaques signalétiques de cette batterie doivent être clairement visibles et ne doivent pas être retirées ou couvertes.
4. L'installateur doit tenir compte de la sécurité des futurs utilisateurs lors du choix de la position et de l'emplacement corrects de la batterie, comme spécifié dans ce manuel.
5. Tenez les enfants à l'écart de la batterie et des systèmes concernés ou de les utiliser à mauvais escient.

La batterie est conçue pour arrêter de se charger lorsqu'elle atteint le seuil bas de 23 °F. Si un courant de charge est observé lorsque la température interne de la batterie est inférieure à 23 °F, débranchez immédiatement la batterie et consultez le distributeur.



Cancer et troubles de la reproduction – Voir www.P65Warnings.ca.gov pour plus de détails.

DISCLAIMER

EG4® se réserve le droit de modifier le contenu de ce document à tout moment sans préavis. Veuillez consulter www.eg4electronics.com pour la version la plus récente de nos manuels/fiches techniques.

5. PACKING LIST

When the product is unpacked, the contents should match those listed below:

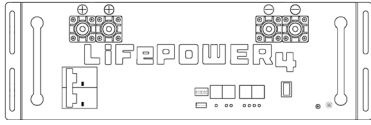

(1) EG4-LifePower4
Battery Module

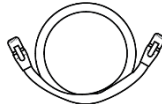

(1) Inter-battery
Communication
Cable

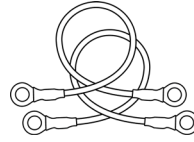

(1) ea. 2 AWG
Pos. and Neg.
Cables



(4) M8*14
Terminal Bolts

6. EQUIPMENT STORAGE

There are a few steps to be taken to ensure that the batteries are stored safely and do not sustain damage during storage.

Battery State

The state of the battery when placed into storage will affect how long it can be stored, as well as the battery's condition when it is brought out of storage. EG4® recommends that each battery is brought to a 50% SOC (state of charge) before placing it in storage. Lithium batteries will lose a certain percentage of their total charge while in storage, depending on how long they are stored and the conditions they are stored in. EG4 recommends recharging the batteries after 8 – 9 months in prolonged storage.

Environmental Factors

The storage location for the EG4 battery can greatly affect the health of the battery.

For best results, the temperature should remain moderate, between 41°F and 68°F (5°C and 20°C). Keep the battery away from locations where it may get wet or locations with high humidity (>55%).

Store the batteries away from combustible materials!

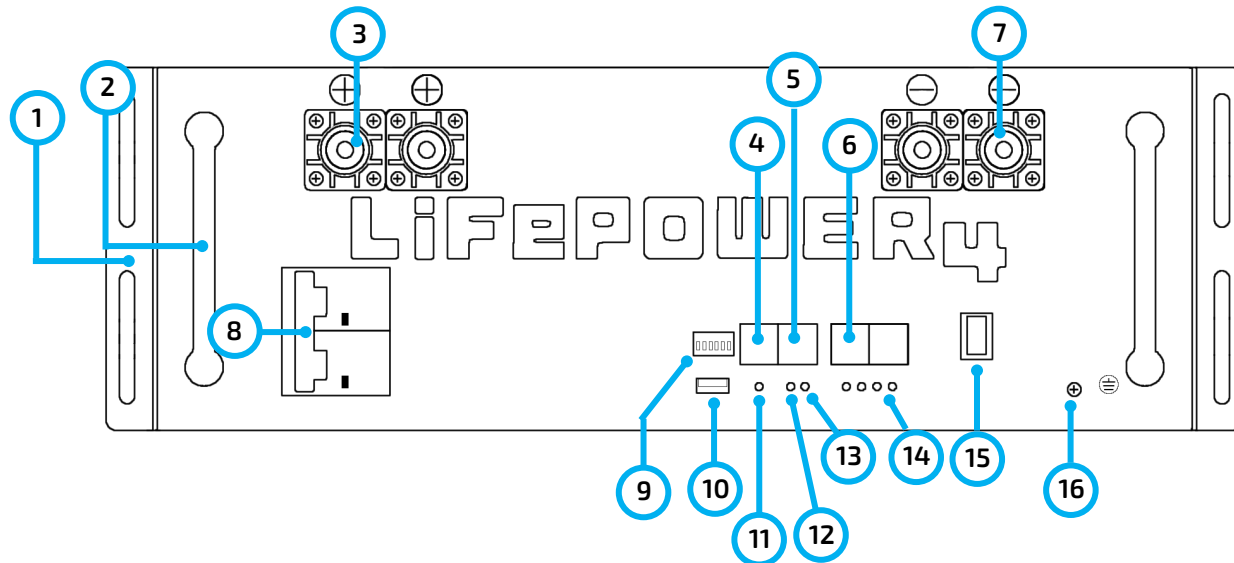

7. FRONT PANEL CALLOUTS

7.1 BATTERY DIAGRAM



NO.	ITEM	DESCRIPTION	REMARKS
1	Rack mount ear	For battery rack mounting	Secures the battery to the rack
2	Handle	For carrying/handling battery	-
3	Positive terminal	M8 bolt (x2)	-
4	CAN	CAN communication interface	Pin 4 – CAN_H Pin 5 – CAN_L
5	RS485	RS485 communication interface	Pin 1 & Pin 8 – RS485B Pin 2 & Pin 7 – RS485A
6	Battery Communications	Battery to battery communication port	Used for closed-loop communication
7	Negative terminal	M8 bolt (x2)	-
8	Breaker	Circuit breaker	DC Output
9	Battery ID DIP Switch	ID for battery arrangement	6 position DIP switch, can support 64 in parallel
10	USB Port	Reserved	-
11	Reset	Emergency Reset	-
12	ALM	Alarm LED Display	-
13	RUN	Run LED Display	-
14	SOC	State Of Charge Display	LEDs indicate charge level
15	ON/OFF Switch	Turn BMS on/off	-
16	GND	Ground connection for safety	-

7.2 LED INDICATOR STATUS & DEFINITION

STATUS	NORMAL/ ALARM/ PROTECTION	RUN	ALM	SOC INDICATOR LED	NOTES
				SOC1~SOC4*	-
Shutdown/Sleep		OFF	OFF	OFF	-
Stand-by	Normal	ON	OFF	Based on battery indicator (Each LED indicates 25% SOC)	-
	Alarm	ON	FLASH		According to the state before stand-by
Charge	Normal	Short flash	OFF		-
	Alarm	Short flash	Short flash		-
	End-off Voltage	OFF	ON		-
	Over-temp Protection	OFF	Short flash	-	
Discharge	Over-current transfer limit protection	Short flash	Short flash/OFF	-	
	Normal	Long flash	OFF	Based on battery indicator	-
	Alarm	Long flash	Long flash		-
	End-off voltage	OFF	OFF		Standby
Over-temp/ Over-current protection	OFF	ON	-		
BMS Fault	-	OFF	Flash	All OFF	-

***NOTE:** Below are two images of the SOC LED and what each LED represents.

NO	SOC %
1	25%
2	50%
3	75%
4	100%

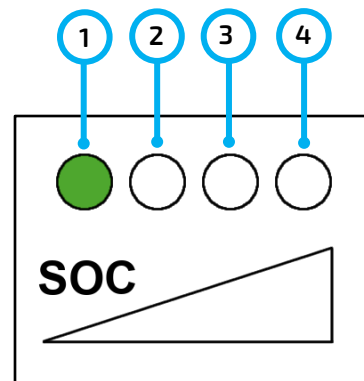

8. INSTALLING THE BATTERY

8.1 GENERAL INSTALLATION



NOTE:

Where ambient temperature is above 86°F (30°C), cable size must be increased according to NEC 310. The 2 AWG cable included in the package is intended only for the connection from the battery module to an EG4® battery rack busbar.

8.2 REQUIREMENTS FOR INSTALLATION

- Make sure the battery breaker is turned off during the installation process to avoid any electrical hazards or damage to the batteries.
- Avoid exposing batteries to conductive materials, such as water, strong oxidizers, and strong acids.
- Avoid putting batteries in direct sunlight or on extremely hot surfaces.
- Keep all flammable materials out of the working area.
- Use caution when handling batteries and/or battery-powered devices to avoid damaging the battery casing or connections.
- Before installing and using the batteries, inspect them for signs of damage. Never use damaged or puffy batteries. Contact the distributor if a battery is received that shows signs of any type of damage.



DANGER!

When adding or removing a battery from any rack, cabinet, or busbar, turn off ALL batteries, and use a voltmeter to confirm there is no voltage present. This will prevent users from encountering live (powered) busbars by accident. Failure to do so can result in severe injury and/or death!

8.3 TOOLS NEEDED FOR INSTALLATION

The tools required may vary depending on the installation location. Typically, the following items are needed to install the battery into an EG4® battery rack solution or general racking:

1. Phillips head screwdriver
2. Torque wrench
3. Proper PPE



WARNING:

Do not put EG4 batteries in series! The BMS and internal components are not designed to handle this setup, which could cause the modules to fail, leading to damage.

8.4 INSTALLATION IN EG4 BATTERY RACK



NOTE:

The image below represents 6 EG4® LifePower4 24V V2 batteries installed in an EG4 Indoor Battery Rack. When installing multiple batteries or adding a battery to an existing rack, please ensure each battery is charged individually to 100% before paralleling them together. This step is crucial to optimize battery performance and ensure proper operation.

1. Insert the battery into the rack slot, beginning with the bottom slot and progressing upward. Slide in until the battery is firmly seated in the rack.
2. **Use the included 2 AWG power cable to connect each battery to the busbar.**
3. **DO NOT** finger tighten the battery or busbar terminal bolts. The battery bolts require a certain torque [60 in-lbs. (6.8Nm)] to ensure they do not loosen during operation. Failure to properly tighten the terminal bolts can result in serious damage and other issues which voids the warranty.
4. Clearly identify the location of the batteries positive and negative terminals—red to the positive terminal and black to the negative terminal. Once identified, connect to the inverter's positive and negative terminals.

Grounding

Attach a grounding wire from the rack/cabinet to an equipment grounding conductor, then terminate the EGC at a grounding electrode.



WARNING:

Do not ground rack/cabinet or door to negative or positive busbars!

In this image, there are 6 LifePower4 V2 200Ah batteries wired in parallel. This battery bank still maintains the appropriate 24V needed for a system. However, the amp hour rating of this bank has increased to 1200Ah. In addition, the potential output amperage of the rack increases.

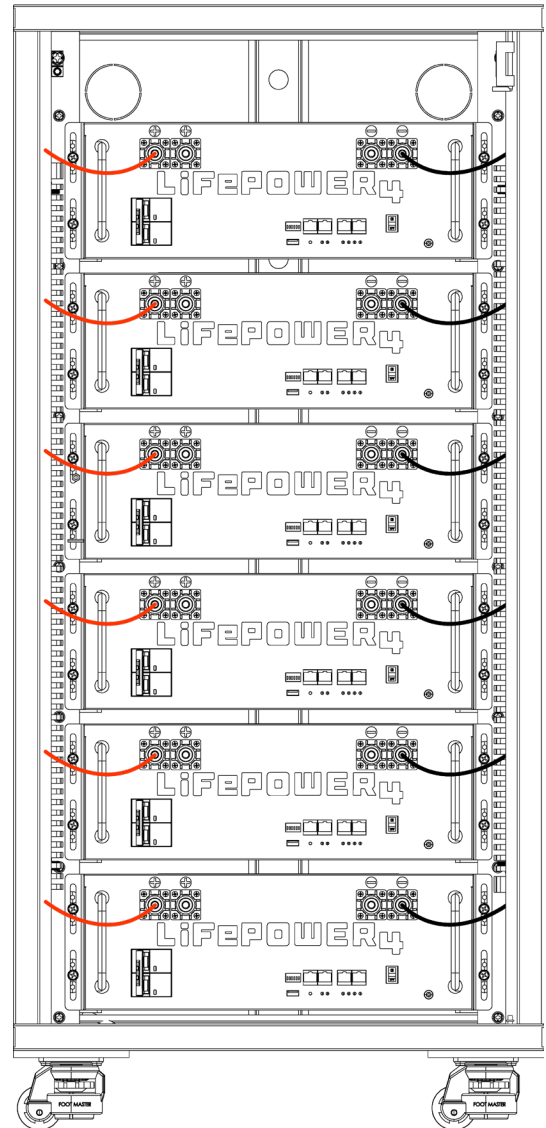

NOTE:

Use the included battery cables or size the battery cables appropriately! Refer to an NEC approved ampacity chart for specifications.



NOTE:

EG4 recommends using a properly sized (amp rated) busbar to parallel batteries together. Paralleling via the battery terminals will cause inconsistent charging and discharging issues in the bank.



CAUTION:

Never position the battery upside down or face down!

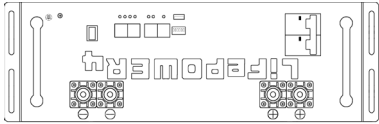

Acceptable

Acceptable

Best

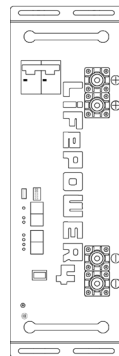
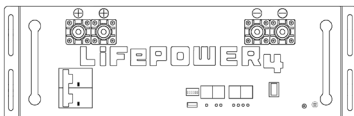

9. BATTERY COMMUNICATIONS

Each EG4® Electronics battery is designed with the end-user in mind, displaying as much information as possible in the simplest manner. EG4 Electronics includes the option of connecting the battery to PC software to monitor the module status. This enables users to monitor and comprehend the battery’s performance and to troubleshoot any issues that may occur.



WARNING:

***Make sure to install the communication cables into their respective ports!
Improper installation may lead to component damage!
EG4 recommends double checking all points of connection before introducing power to the system to mitigate any potential issues.***



NOTE:

The short communications cable that connects from battery to battery is a standard CAT5 cable with a straight through pinout. If the battery to inverter communications cable is not long enough to span the distance from inverter to master battery, refer to the communication cable pinout table in the following section.

9.1 COMMUNICATION CABLE PINOUT AND DIP SWITCH ID TABLES

EG4® LifePower4 24V V2 batteries can support up to 64 modules in parallel, each with their own DIP switch configuration. The batteries interface with the inverter by designating a “Host” battery (DIP switch ID No. 1) with each subsequent battery using sequential configurations.

























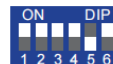







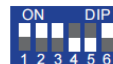





























For Victron communication cables, contact the distributor.



PIN	DESCRIPTION
1	RS485B
2	RS485A
3	CAN Ground (optional)
4	CAN High
5	CAN Low

***Pinouts are for battery side;
please refer to the system
manual for pinout
configuration on system end**

DIP switch ID table – 6 Pin

 ID:1	 ID:2	 ID:3	 ID:4	 ID:5	 ID:6	 ID:7	 ID:8
 ID:9	 ID:10	 ID:11	 ID:12	 ID:13	 ID:14	 ID:15	 ID:16
 ID:17	 ID:18	 ID:19	 ID:20	 ID:21	 ID:22	 ID:23	 ID:24
 ID:25	 ID:26	 ID:27	 ID:28	 ID:29	 ID:30	 ID:31	 ID:32
 ID:33	 ID:34	 ID:35	 ID:36	 ID:37	 ID:38	 ID:39	 ID:40
 ID:41	 ID:42	 ID:43	 ID:44	 ID:45	 ID:46	 ID:47	 ID:48
 ID:49	 ID:50	 ID:51	 ID:52	 ID:53	 ID:54	 ID:55	 ID:56
 ID:57	 ID:58	 ID:59	 ID:60	 ID:61	 ID:62	 ID:63	 ID:64



REMINDER

When paralleling multiple batteries, all DIP switch settings must be different from each other. This allows all equipment to see each battery in the bank separately. EG4 recommends addressing the batteries in ascending order.

9.2 MULTIPLE BATTERY PARALLEL INSTALL



NOTE:

When installing multiple batteries or adding a battery to an existing rack, please ensure all batteries are charged to 100% before paralleling together. This step is crucial to optimize battery performance and ensure proper operation.

Follow the steps outlined below to ensure proper installation of multiple batteries in parallel.

1. Ensure all circuit breakers are open (off). Using a multimeter, check for voltage at all available disconnects and lines. Once no voltage is confirmed, proceed to the next step.
2. Set the DIP switch address on the master battery to address 1, and all other batteries in parallel to differing addresses going in ascending order. (See image) →
3. Reset the battery BMS via the power button to register the address change.
4. Set up communication between the batteries via the “Battery-Comm” ports by using a CAT 5, 5e, or 6 cable.

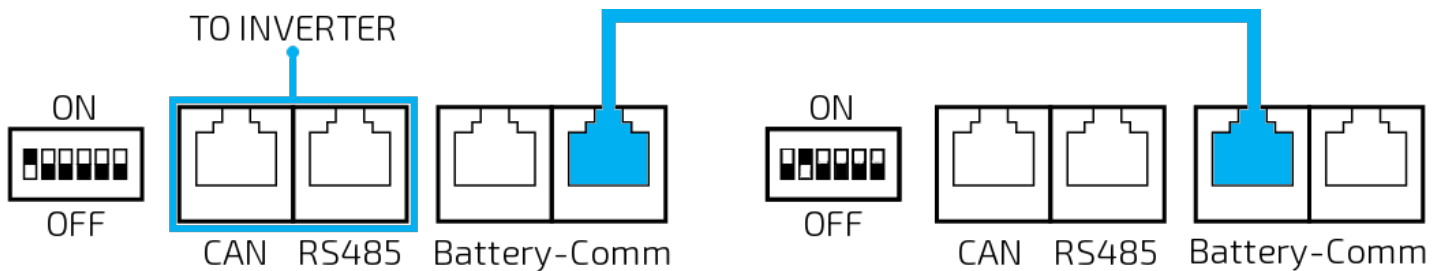
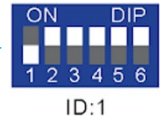

5. The battery set to address 1 will connect directly to the inverter BMS communication port via CAT 5, 5e or CAT 6 cable.



REMINDER:

The battery can charge/discharge up to 200A before the BMS shuts off the pack. Ensure the inverter is configured to handle this high of a current and size all wires accordingly! Refer to an NEC approved ampacity chart or consult with the installer or a solar electrician for more information.

For more information regarding paralleling batteries, use the QR code below to navigate to the Connection Overview & Paralleling Guide.



10. BMS TOOLS

10.1 INTRODUCTION TO THE BMS

The BMS is intended to safeguard the battery and battery cells against a variety of situations that could damage or destroy system components. This protection also aids in keeping the battery and battery cells operational for a greater number of life cycles. Each EG4® LifePower4 battery is specifically configured to ensure peak performance and operation with any system.

PCB temperature protection

The BMS will ensure that the Printed Circuit Board (PCB) does not overheat. This is the part that houses most of the “brains” of the battery. This feature will turn the battery off if it begins to overheat.

Cell balance protection

Cell balance ensures that each cell is within a specific voltage range of each other. Cell balance is crucial for ensuring that the battery is operating properly for its lifespan. This is done automatically.

Environmental temperature protection

It may be dangerous to attempt to use the battery in extreme heat or cold. Continued operation in these conditions may result in permanent damage to the battery module and its components. To prevent this, the BMS is designed to measure the temperature while charging/discharging and will shut down the battery to prevent damage.

Voltage protection

The BMS is designed to continuously monitor the voltage of each individual cell and ensure that they are not over/undercharged.

Current protection

The BMS is designed to constantly monitor the charge/discharge amperage and has built-in safeguards against exceeding specific parameters. These include delayed shut down for high amperage and built-in timers that shut off quickly in the event of short circuits.

10.2 BMS TOOLS INSTALLATION AND INTERFACING

The PC software “*BMS Tools*” provides real-time battery analysis and diagnostics. The battery cannot communicate with BMS Tools and a closed loop inverter at the same time.

Visit <https://eg4electronics.com/resources/downloads> to get the latest version of the software. The file can be located on the downloads page underneath the product in question.

Once the file has been downloaded, unzip the .zip file. Once the file is unzipped, refer to the included “Connection guide for BMS Tools V1.0.pdf” for an extensive walkthrough to set up BMS Tools.

If confirmation of the port numbers for battery to PC communications is needed, please consult the following section.

For instructions on how to interface with BMS Tools, please scan the QR codes below.



BMS Tools White Sheet



**BMS Tools Video
Walkthrough**

11. FIRMWARE UPDATES

Always ensure all system components are fully up to date before commissioning the system and that all battery firmware is up to date to support proper closed loop communication.

Please visit <https://eg4electronics.com/resources/downloads> for the latest firmware.

12. TROUBLESHOOTING, MAINTENANCE & DISPOSAL

12.1 BATTERY CHARGING

Ensure the proper settings are set on the charge controller and/or inverter being used to avoid overcharging or damaging the module.

(Refer to Section 2: Technical Specifications Table for a full list of charging/discharging parameters.)



IMPORTANT:

It is normal for lithium batteries with an internal BMS that are wired in parallel to demonstrate a wide variety of SOC readings during any given charge or discharge cycle. Variations of up to 10% are common. This is not cause for concern or indication that the module is providing less than the maximum capacity. This can be caused by a few different factors, including variations in wire resistance, internal battery resistance, temperature differences and cell variations. Even a slight variation causes one battery to take more of the load or charge for a short time. Over the duration of the discharge or charge cycle, this will balance out with the lagging battery taking the load or charge at the other end of the cycle resulting in recovering the full listed kWh capacity of the pack. The voltage differences created as batteries diverge in SOC will eventually cause them to converge at some point in the cycle.

12.2 ALARM DESCRIPTION AND TROUBLESHOOTING

When the ALM light on the battery control panel is on, it means that the battery has given an alarm or has been protected from potential damage. Please check the cause of the failure through EG4® Monitor Center or BMS Tools and take appropriate measures or go directly to the battery site to troubleshoot.

BMS Tools alarms are shown in the table below.

Warning and Protect Status Definitions Table:

STATUS	NAME	DEFINITION	ACTION
Charge	Charge OT	Charge over-temperature	Power off module and cool down location.
	Charge UT	Charge under-temperature	Power off module and warm up location.
Discharge	Discharge OT	Discharge over-temperature	Power off module and cool down location.
	Discharge UT	Discharge under- temperature	Power off module and warm up location.



NOTE:

The “Historical Record” tab, which can be found in the BMS Tools program, can indicate what occurred with the module before entering a warning or protection state. It is recommended to export this data into a text (.txt) file to provide to the distributor for any additional troubleshooting assistance.

Other Common Faults and Solutions

FAULT	ANALYSIS	ACTION
Inverter communication failure	Check communication port connection and battery ID setting.	Select proper "host" battery DIP switch address and power cycle the battery.
No DC output	Open breaker, or battery voltage is too low.	Check battery breaker and/or charge the battery.
Power supply unstable	Battery capacity is not at full power.	Check for proper battery cable connection.
Battery cannot be charged fully	DC output voltage is below the minimum charge voltage.	Check the charging settings on the inverter to ensure they match battery requirements.
ALM LED always on	Short circuit	Turn off the battery breaker and check all cabling.
The battery output voltage is unstable.	Battery management system does not operate normally.	Press the reset button to reset the battery, then reboot the system.
ALM LED flashes 20 times with SOC1 LED on.	Unbalanced voltage within a cell	Deep discharge the battery bank (<20% SOC), then charge battery bank fully.
ALM LED flashes 20 times with SOC2 LED on.	Unbalanced temperature	Contact the distributor.
ALM LED flashes 20 times with SOC3/4 LED on.	BMS damaged	Contact the distributor.
Different SOC value of batteries in parallel operation.	No issue	Deep discharge the battery bank (<20% SOC), then charge battery bank fully.
Low voltage protection with no LED on	BMS is in low voltage protection, and is in sleep mode	Follow the below steps to reboot the module. 1. Charge the battery immediately and it will reboot itself. 2. Switch off and switch on, when on, charge it immediately. If you follow step 1 or step 2 without charging immediately, the BMS will go into protect mode and go to sleep mode shortly after.
Deeply discharged with "RUN" LED on	The battery voltage is too low to start BMS.	Contact the distributor.



NOTE:

If any of the warnings or faults from both tables persist, please contact the distributor for additional troubleshooting steps.

12.3 LONG TERM MAINTENANCE

ITEM	MAINTENANCE METHOD	MAINTENANCE INTERVALS
Power Cables	<ol style="list-style-type: none"> 1. Check whether there is mechanical damage to the power cable and whether the terminal insulation sleeve has fallen off. If there is such an occurrence, turn off the battery and carry out maintenance or replacement. 2. Check whether the power cable is loose; if there is any sign of looseness, use a standard torque wrench to tighten it. 3. Check the system for loose screws or discoloration of the copper busbar; if the screws are loose, tighten them with a standard torque wrench. If the copper busbar is discolored, contact the manufacturer for after-sales replacement. 	Once every 6 months
Communication Cables	<ol style="list-style-type: none"> 1. Confirm whether the battery communication cable is properly connected to the RJ45 terminals. 2. Check whether the color of the communication cable has obvious discoloration. If discolored, shut down the machine and replace the communication cable. 	Once a year
Cabinet Cleanliness	Check the cleanliness of the front door, back door and battery module inside the cabinet. If there is dust, dirt, or debris, clean accordingly.	Once every 6-12 months
System Running Status	<ol style="list-style-type: none"> 1. Check if all parameters are normal when the system is running (system voltage, current, temperature, etc.) 2. Check whether the main core components of the system are normal, (system switches, contactors, etc.,) showing no faults or warnings. 	Once every 6 months
Charge and Discharge Maintenance	Use light loads and shallow charge/discharge to check whether the SOC, SOH status of the battery is normal (using the BMS Tools computer software to read); it is recommended that the depth of discharge and charge/discharge power should not exceed 20% of the rated value.	Once every 6 months

12.4 BATTERY END OF LIFE

The EG4® LifePower4 24V battery is designed to last for *more than 15 years* when used correctly. We have worked tirelessly to ensure that our batteries will maintain a charge after thousands of cycles. However, when it does come time to retire the battery, there are a few things to consider. Lithium iron phosphate batteries are considered a hazardous material and should not be disposed of by simply placing them in the trash. There are several websites and organizations that will accept this battery to recycle at little to no cost to the user. At EG4, we understand that we are working with customers across the United States and the world. Our recommendation is to go online and search the term “Lithium Battery Disposal Near Me.” There will likely be an assortment of organizations that can safely dispose of LFP batteries.

We recommend calling ahead of time to ensure that the location is still open and accepting material.

If users are unable to locate a disposal location safely, EG4 is here to help. Before dumping the battery or disposing of it incorrectly, please contact our customer service team for assistance.

13. WARRANTY INFORMATION

For information regarding warranty registration on EG4® Electronics products, please navigate to <https://eg4electronics.com/warranty/> and select the corresponding product to begin the registration process.

14. CHANGELOG

Version 1.3.2

- Added French warnings/dangers section

Version 1.3.1

- Modified warranty in section 12

Version 1.3

- Removed cert logos

Version 1.2

- Added P65 Warning to safety information
- Modified max recommended charge from 100A to 30A
- Added additional certification logos to cover page
- Modified M8 screw size in packing list

Version 1.1

- Modified cell information and certifications
- Modified verbiage on cover page

Version 1.0

- First version release



CONTACT US

support@eg4electronics.com

(903) 609-1988

www.eg4electronics.com