

EG4[®] LIFEPOWER4 24V V2 SERVER RACK

CONNECTIONS OVERVIEW & PARALLELING GUIDE



TABLE OF CONTENTS

1.	TECHNICAL SPECIFICATIONS	1
2.	BATTERY SAFETY	3
2.1	SAFETY INSTRUCTIONS.....	3
2.2	IMPORTANT SAFETY NOTIFICATIONS	3
3.	SÉCURITÉ DE LA BATTERIE.....	5
3.1	CONSIGNES DE SÉCURITÉ	5
3.2	NOTIFICATIONS DE SÉCURITÉ IMPORTANTES.....	5
4.	FRONT PANEL CALLOUTS	7
4.1	BATTERY DIAGRAM	7
4.2	LED INDICATOR STATUS & DEFINITION	8
4.3	PRE-WIRE STEPS AND WIRING	9
4.4	MULTIMETER TESTING AND WIRING	9
5.	EXAMPLE CONNECTION CONFIGURATIONS.....	10
6.	BATTERY COMMUNICATIONS.....	11
6.1	COMMUNICATION CABLE PINOUT AND DIP SWITCH ID TABLES.....	11
6.2	MULTIPLE BATTERY PARALLEL INSTALL	13
7.	WARRANTY INFORMATION	15
8.	CHANGELOG.....	16

1. TECHNICAL SPECIFICATIONS

MODULE OPERATING PARAMETERS			
PARAMETER	BMS	RECOMMENDED	
VOLTAGE	25.6V	-	
CAPACITY	200Ah	-	
CHARGING VOLTAGE (BULK/ABSORB)	28.0 ± 0.4V	-	
SOC CUTOFF	22.4V	20%*	
CHARGING CURRENT	200A (Max. continuous)	30A	
DISCHARGING CURRENT	200A (Max. continuous)	-	
MAXIMUM CONTINUOUS DISCHARGE RATE	5.12kW	-	
NAMEPLATE ENERGY CAPACITY	5.12kWh	-	
BMS PARAMETERS			
CHARGE	SPEC	DELAY	RECOVERY
CELL VOLTAGE PROTECTION	3.8V	1 sec	3.45V
MODULE VOLTAGE PROTECTION	30.0V	1 sec	27.6V
OVER CHARGING CURRENT 1	>220A	10 sec	-
OVER CHARGING CURRENT 2	≥250A	3 sec	-
TEMPERATURE PROTECTION	<23°F or >158°F <-5°C or >70°C	1 sec	>41°F or <140°F >5°C or <60°C
DISCHARGE			
CELL VOLTAGE PROTECTION	2.3V	1 sec	3.1V
MODULE VOLTAGE PROTECTION	22.4V	1 sec	24.0V
OVER DISCHARGING CURRENT 1	>220A	30 sec	60 sec
OVER DISCHARGING CURRENT 2	>300A	5 sec	60 sec
SHORT-CIRCUIT	>500A	<0.1 mS	-
TEMPERATURE PROTECTION	<-4°F or >167°F <-20°C or >75°C	1 sec	>14°F or <149°F >-10°C or <65°C
PCB TEMP PROTECTION	>221°F (>105°C)	1 sec	<176°F (<80°C)

*EG4 recommends this value be set no lower than 20% to maintain the recommended 80% depth of discharge.

GENERAL SPECIFICATIONS			
PARAMETER	SPEC	TYPE	CONDITION
CELL BALANCE	120mA	Passive Balance	Cell Voltage Difference >40mV
TEMPERATURE ACCURACY	3%	Cycle Measurement	Measuring Range 40°F – 212°F (-40°C – 100°C)
VOLTAGE ACCURACY	0.5%	Cycle Measurement	For Cells/Module
CURRENT ACCURACY	3%	Cycle Measurement	Measurement Range +/-200A
SOC	5%	-	Integral Calculation
POWER CONSUMPTION (SLEEP & OFF MODE)	<300uA	-	Storage/Transport/Standby
POWER CONSUMPTION (OPERATING)	<20mA	-	Charging/Discharging
COMMUNICATION PORTS	RS485/CAN	-	Customizable
MAXIMUM MODULES IN SERIES		1	
MAXIMUM MODULES IN PARALLEL		64	
DIMENSION (H×W×D)	6.1×19×17.4 in. (155×442×470 mm)		
WEIGHT	99.2 lbs. (45 kg)		
ENVIRONMENTAL PARAMETERS			
CHARGING RANGE	32°F – 113°F (0°C – 45°C)		
DISCHARGING RANGE	-4°F – 122°F (-20°C – 50°C)		
STORAGE RANGE	-4°F – 122°F (-20°C – 50°C)		
INGRESS PROTECTION	IP21		

2. BATTERY SAFETY

2.1 SAFETY INSTRUCTIONS

Before any work begins, carefully read all safety instructions, and always observe them when working on or with the battery. The installation must follow all applicable national or local standards and regulations. Consult with the local AHJ to obtain the proper permits and permissions before installation.

Incorrect installation may cause:

- *Injury or death to the installer, operator or third party*
- *Damage to the battery or other attached equipment*

2.2 IMPORTANT SAFETY NOTIFICATIONS



DANGER: Hazardous Voltage Circuits!

There are various safety concerns that must be carefully observed before, during, and after the installation, as well as during future operation and maintenance. The following are important safety notifications for the installer and any end users of this product under normal operating conditions.

1. **Do not disassemble the battery.** Contact the distributor for any issues that need repair for more information and proper handling instructions. Incorrect servicing or re-assembly may result in a risk of electric shock or fire and void the warranty.
2. **Never short-circuit DC inputs.** Short-circuiting the battery may result in a risk of electric shock or fire and can lead to severe injury or death and/or permanent damage to the unit and/or any connected equipment.
3. **Use caution when working with metal tools on or around batteries and systems.** **Risk** of electrical arcs and/or short circuiting of equipment can lead to severe injury or death and equipment damage.
4. **Beware of high battery current.** Ensure that the battery module breakers and/or on/off switches are in the “open” or “off” position before installing or working on the battery. Use a voltmeter to confirm there is no voltage present to avoid electric shock.
5. **Do not make any connections or disconnections to the system while the batteries are operating.** Damage to system components or risk of electrical shock may occur if working with energized batteries.
6. Make sure the battery and rack are properly grounded.
7. An installer should make sure to be well protected by reasonable and professional insulative equipment [e.g., personal protective equipment (PPE)].
8. Before installing, operating, or maintaining the system, it is important to inspect all existing wiring to ensure it meets the appropriate specifications and conditions for use.
9. Ensure that the battery and system component connections are secure and proper to prevent damage or injuries caused by improper installation.



WARNING: TO REDUCE THE RISK OF INJURY, READ ALL INSTRUCTIONS!

All work on this product (system design, installation, operation, setting, configuration, and maintenance) must be carried out by qualified personnel. To reduce the risk of electric shock, do not perform any servicing other than those specified in the operating instructions unless qualified to do so.

1. Read all instructions before commencing installation. For electrical work, follow all local and national wiring standards, regulations, and these installation instructions. All wiring should be in accordance with the National Electrical Code (NEC), ANSI/NFPA 70.
2. The battery and system can connect with the utility grid only if the utility provider permits. Consult with the local AHJ before installing this product for any additional regulations and requirements for the area.
3. All warning labels and nameplates on this battery should be clearly visible and must not be removed or covered.
4. The installer should consider the safety of future users when choosing the battery's correct position and location as specified in this manual.
5. Keep children away from touching or misusing the battery and relevant systems.

The battery is designed to stop charging when reaching the low threshold of 32°F. If charging current is observed when the internal battery temperature is below 32°F, disconnect battery immediately and consult distributor.



WARNING!

Cancer and Reproductive Harm – See www.P65Warnings.ca.gov for more details.

DISCLAIMER

EG4 reserves the right to make changes to the material herein at any time without notice.

Please refer to www.eg4electronics.com for the most updated version of our manuals/spec sheets.

3. SÉCURITÉ DE LA BATTERIE

3.1 CONSIGNES DE SÉCURITÉ

Avant de commencer tout travail, lisez attentivement toutes les consignes de sécurité et respectez-les toujours lorsque vous travaillez sur ou avec la batterie. L'installation doit être conforme à toutes les normes et réglementations nationales ou locales applicables. Consultez l'autorité compétente locale et/ou le service public pour obtenir les permis et les autorisations appropriés avant l'installation.

Une installation incorrecte peut entraîner les effets suivants :

- *Blessure ou décès de l'installateur, de l'exploitant ou d'un tiers*
- *Domages à la batterie ou à tout autre équipement attaché*

3.2 NOTIFICATIONS DE SÉCURITÉ IMPORTANTES



DANGER: *Circuits à haute tension!*

Il existe divers problèmes de sécurité qui doivent être soigneusement observés avant, pendant et après l'installation, ainsi que lors de l'utilisation et de la maintenance futures. Ce qui suit sont des notifications de sécurité importantes pour l'installateur et tout utilisateur final de ce produit dans des conditions de fonctionnement normales.

1. **Ne démontez pas la batterie.** Contactez le distributeur pour tout problème nécessitant une réparation pour plus d'informations et des instructions de manipulation appropriées. Un entretien ou un remontage incorrect peut entraîner un risque d'électrocution ou d'incendie et annuler la garantie.
2. **Ne court-circuitez jamais les entrées CC.** Un court-circuit de la batterie peut entraîner un risque d'électrocution ou d'incendie et peut entraîner des blessures graves ou la mort et/ou des dommages permanents à l'appareil et/ou à tout équipement connecté.
3. **Soyez prudent lorsque vous travaillez avec des outils métalliques sur ou à proximité des batteries et des systèmes.** Le risque d'arcs électriques et/ou de court-circuit de l'équipement peut entraîner des blessures graves ou la mort et des dommages à l'équipement.
4. **Attention au courant de batterie élevé.** Assurez-vous que les disjoncteurs du module de batterie et/ou les interrupteurs marche/arrêt sont en position « ouvert » ou « arrêt » avant d'installer ou de travailler sur la batterie. Utilisez un voltmètre pour confirmer qu'il n'y a pas de tension présente afin d'éviter les chocs électriques.
5. **N'effectuez aucune connexion ou déconnexion du système pendant que les batteries fonctionnent.** Des dommages aux composants du système ou un risque d'électrocution peuvent survenir si vous travaillez avec des batteries sous tension.
6. Assurez-vous que le banc de batteries est correctement mis à la terre.
7. Un installateur doit s'assurer d'être bien protégé par un équipement isolant raisonnable et professionnel [par exemple, un équipement de protection individuelle (EPI)].
8. Avant d'installer, d'utiliser ou d'entretenir le système, il est important d'inspecter tout le câblage existant pour s'assurer qu'il répond aux spécifications et aux conditions d'utilisation appropriées.
9. Assurez-vous que les connexions de la batterie et des composants du système sont sécurisées et appropriées pour éviter les dommages ou les blessures causés par une mauvaise installation.



AVERTISSEMENT : Pour réduire le risque de blessure, lisez toutes les instructions !

Tous les travaux sur ce produit (conception du système, installation, fonctionnement, réglage, configuration et maintenance) doivent être effectués par du personnel qualifié. Pour réduire le risque d'électrocution, n'effectuez aucun entretien autre que ceux spécifiés dans le mode d'emploi, à moins d'être qualifié pour le faire.

1. Lisez toutes les instructions avant de commencer l'installation. Pour les travaux électriques, suivez toutes les normes de câblage locales et nationales, les réglementations et ces instructions d'installation. Tout le câblage doit être conforme au Code national de l'électricité (NEC), ANSI/NFPA 70.
2. La batterie et le système ne peuvent se connecter au réseau public que si le fournisseur d'électricité l'autorise. Consultez l'AHJ local avant d'installer ce produit pour connaître les réglementations et exigences supplémentaires de la région.
3. Toutes les étiquettes d'avertissement et les plaques signalétiques de cette batterie doivent être clairement visibles et ne doivent pas être retirées ou couvertes.
4. L'installateur doit tenir compte de la sécurité des futurs utilisateurs lors du choix de la position et de l'emplacement corrects de la batterie, comme spécifié dans ce manuel.
5. Tenez les enfants à l'écart de la batterie et des systèmes concernés ou de les utiliser à mauvais escient.

La batterie est conçue pour arrêter de se charger lorsqu'elle atteint le seuil bas de 23 °F. Si un courant de charge est observé lorsque la température interne de la batterie est inférieure à 23 °F, débranchez immédiatement la batterie et consultez le distributeur.



Cancer et troubles de la reproduction – Voir www.P65Warnings.ca.gov pour plus de détails.

DISCLAIMER

EG4® se réserve le droit de modifier le contenu de ce document à tout moment sans préavis. Veuillez consulter www.eg4electronics.com pour la version la plus récente de nos manuels/fiches techniques.

4. FRONT PANEL CALLOUTS

4.1 BATTERY DIAGRAM

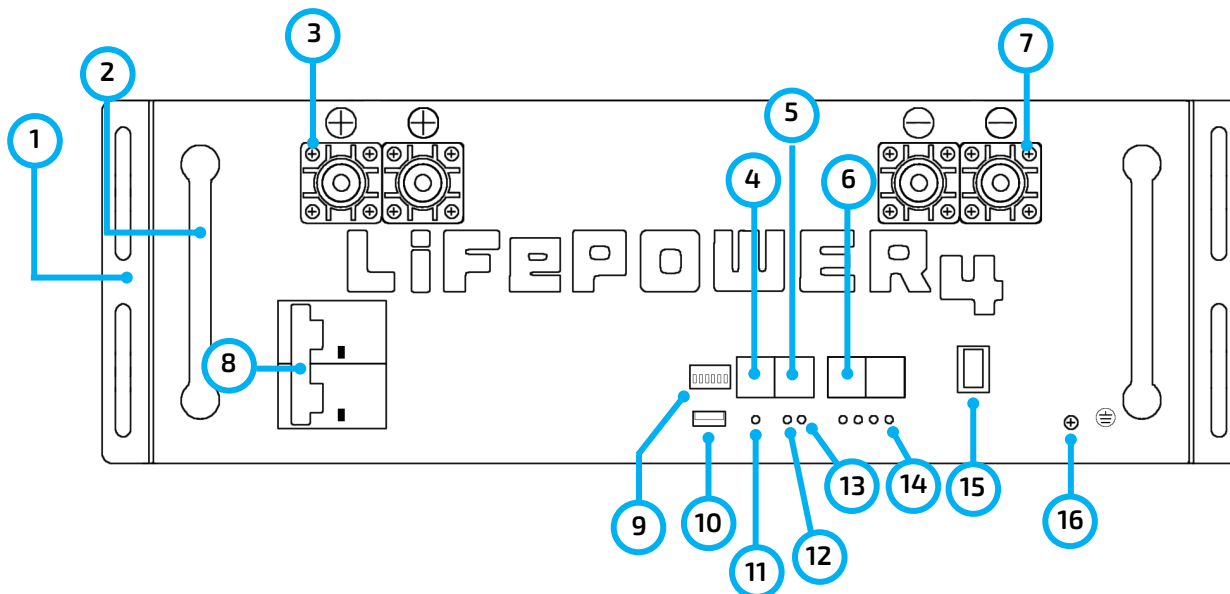

NO.	ITEM	DESCRIPTION	REMARKS
1	Rack mount ear	For battery rack mounting	Secures the battery to the rack
2	Handle	For carrying/handling battery	-
3	Positive terminal	M8 bolt (x2)	-
4	CAN	CAN communication interface	Pin 4 – CAN_H Pin 5 – CAN_L
5	RS485	RS485 communication interface	Pin 1 & Pin 8 – RS485B Pin 2 & Pin 7 – RS485A
6	Battery Communications	Parallel battery communication port	Used for closed-loop communication
7	Negative terminal	M8 bolt (x2)	-
8	Breaker	Circuit breaker	DC output
9	Battery ID DIP Switch	ID for battery arrangement	6 position DIP switch, can support 64 in parallel
10	USB Port	Reserved	-
11	Reset	Emergency Reset	-
12	ALM	Alarm LED Display	-
13	RUN	Run LED Display	-
14	SOC	State Of Charge Display	LEDs indicate charge level
15	ON/OFF Switch	Turn BMS on/off	-
16	GND	Ground connection for safety	-

4.2 LED INDICATOR STATUS & DEFINITION

STATUS	NORMAL/ ALARM/ PROTECTION	RUN	ALM	SOC INDICATE LED	NOTES
		●	●		
Shutdown/Sleep		OFF	OFF	SOC1 ~ SOC4*	-
Stand-by		ON	OFF	Based on battery indicator (Each LED indicates 25% SOC)	-
Normal		ON	OFF		-
Alarm		ON	FLASH		According to the state before stand-by
Charge		Short flash	OFF		-
End-off Voltage		OFF	ON		-
Over-Temp Protection		OFF	Short flash	-	
Over-current transfer limit protection		Short flash	Short flash/OFF	-	
Discharge		Long flash	OFF	Based on battery indicator	-
Normal		Long flash	OFF		-
Alarm		Long flash	Long flash		Standby
End-off Voltage		OFF	OFF		-
Over-Temp/ Over-current Protection		OFF	ON	-	
BMS Fault	-	OFF	Flash	All OFF	-

***NOTE:** Below are two images of the SOC LED and what each LED represents.

NO	SOC %
1	25%
2	50%
3	75%
4	100%

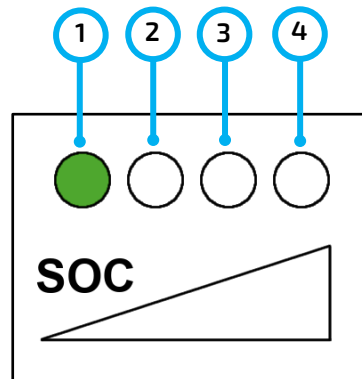

4.3 PRE-WIRE STEPS AND WIRING

The battery will come with 1 set of 2 AWG power cables. Please refer to the inverter documentation that the battery will be connected to for torque specs and wire sizing needs for specific use cases. Where ambient temperature is above 86°F (30°C), cable size must be increased according to NEC 310. The 2 AWG cable included in the package is intended only for the connection from the module to an EG4® battery rack busbar.



DANGER:

No connections should be made until the proper polarity of the cables have been confirmed between the battery and inverter!

4.4 MULTIMETER TESTING AND WIRING

Follow the steps outlined below to both test the inputs and wire the battery to the system. Refer to the system's user manual for specific torque values. If using non-EG4® inverters, refer to the appropriate manufacturer user manual.



CAUTION:

The battery can charge/discharge up to 200A before the BMS will shut it off. Ensure the inverter is configured to handle this high of a current and size all wires according to an NEC approved ampacity chart. Consult with the installer or a solar electrician for more information.

1. Ensure all circuit breakers in the system are open (off). Using a multimeter, check for voltage at all available disconnects and lines. Once no voltage is confirmed, proceed to the next step.
2. Connect the included set of 2 AWG to the battery's positive and negative terminals, respectively.
3. If applicable, route the battery power cables through the conduit box to the inverter before making any connections!
4. Ensure proper polarity of cables. Once confirmed, proceed to the next step.
5. Install the positive battery cable to the inverter's positive battery terminals following proper torque values.
6. Install the negative battery cable to the inverter's negative battery terminals following proper torque values.

5. EXAMPLE CONNECTION CONFIGURATIONS



NOTE:

The image below represents 6 EG4® LifePower4 24V V2 batteries installed in an EG4 Indoor Cabinet. When installing multiple batteries or adding a battery to an existing rack, please ensure each battery is charged individually to 100% before paralleling them together. This step is crucial to optimize battery performance and ensure proper operation.

1. Insert the battery into the rack slot, beginning with the bottom slot and progressing upward. Slide in until the battery is firmly seated in the rack.
2. **Use the included 2 AWG power cable to connect each battery to the busbar.**
3. **DO NOT** finger tighten the battery or busbar terminal bolts. The battery bolts require a certain torque [60 in-lbs. (6.8Nm)] to ensure they do not loosen during operation. Failure to properly tighten the terminal bolts can result in serious damage and will void the warranty.
4. Clearly identify the location of the batteries positive and negative terminals—red to the positive terminal and black to the negative terminal. Once identified, connect to the inverter's positive and negative terminals.

Grounding

Attach a grounding wire from the rack/cabinet to an equipment grounding conductor, then terminate the EGC at a grounding electrode.



WARNING:

Do not ground rack/cabinet or door to negative or positive bus bars!

In this image, there are 6 EG4 LifePower4 V2 200Ah batteries wired in parallel. This battery bank still maintains the appropriate 24V needed for a system. However, the amp hour rating of this bank increases to 1200Ah. In addition, the potential output amperage of the rack has increased.



NOTE:

Use the included battery cables or size the battery cables appropriately! Refer to an NEC approved ampacity chart for specifications.



NOTE:

EG4 recommends using a properly sized (amp rated) busbar to parallel batteries together. Paralleling via the battery terminals will cause inconsistent charging and discharging issues in the bank.

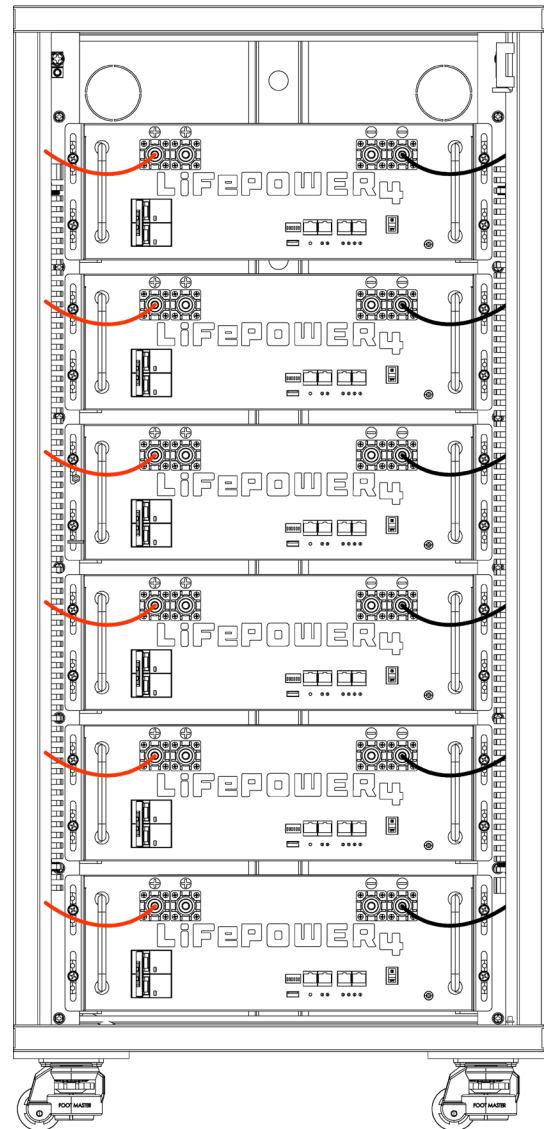

6. BATTERY COMMUNICATIONS

Each EG4® battery is designed with the end-user in mind, displaying detailed information in the simplest manner possible. EG4 Electronics includes the option of connecting the battery to PC software to monitor the module status, allowing the user to know exactly what the battery is doing and troubleshoot any problems that may arise.

For more information on battery to PC monitoring using BMS Tools, refer to “Device & Monitoring Guide” by scanning the QR code below.



WARNING:

Make sure to install the communication cables into their respective ports! Improper installation may lead to component damage! EG4 recommends double checking all points of connection before introducing power to the system to mitigate any potential issues.



NOTE:

The short communications cable that connects from battery to battery is a standard CAT5 cable with a straight through pinout. If the battery to inverter communications cable is not long enough to span the distance from inverter to master battery, refer to the communication cable pinout table in the following section.

6.1 COMMUNICATION CABLE PINOUT AND DIP SWITCH ID TABLES

EG4® LifePower4 24V V2 batteries can support up to 64 modules in parallel, each with their own DIP switch configuration. The batteries interface with the inverter by designating a “Host” battery (DIP switch ID No. 1) with each subsequent battery using sequential configurations.

























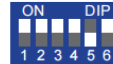









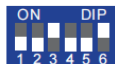

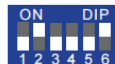
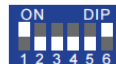
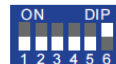
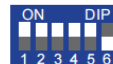
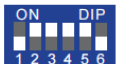





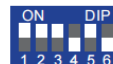













For Victron communication cables, contact the distributor.



PIN*	DESCRIPTION
1	RS485B
2	RS485A
3	CAN Ground (optional)
4	CAN High
5	CAN Low

***Pinouts are for battery side; please refer to the system manual for pinout configuration on system end**

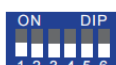
DIP switch ID table – 6 Pin

 ID:1	 ID:2	 ID:3	 ID:4	 ID:5	 ID:6	 ID:7	 ID:8
 ID:9	 ID:10	 ID:11	 ID:12	 ID:13	 ID:14	 ID:15	 ID:16
 ID:17	 ID:18	 ID:19	 ID:20	 ID:21	 ID:22	 ID:23	 ID:24
 ID:25	 ID:26	 ID:27	 ID:28	 ID:29	 ID:30	 ID:31	 ID:32
 ID:33	 ID:34	 ID:35	 ID:36	 ID:37	 ID:38	 ID:39	 ID:40
 ID:41	 ID:42	 ID:43	 ID:44	 ID:45	 ID:46	 ID:47	 ID:48
 ID:49	 ID:50	 ID:51	 ID:52	 ID:53	 ID:54	 ID:55	 ID:56
 ID:57	 ID:58	 ID:59	 ID:60	 ID:61	 ID:62	 ID:63	 ID:64



REMINDER:

When paralleling multiple batteries, all DIP switch settings must be different from each other. This allows all equipment to see each battery in the bank separately.

EG4 recommends addressing the batteries in ascending order.

6.2 MULTIPLE BATTERY PARALLEL INSTALL



NOTE:

When installing multiple batteries or adding a battery to an existing rack, please ensure all batteries are charged to 100% before paralleling together. This step is crucial to optimize battery performance and ensure proper operation.

Follow the steps outlined below to ensure proper installation of multiple batteries in parallel.

1. Ensure all circuit breakers are open (off). Using a multimeter, check for voltage at all available disconnects and lines. Once no voltage is confirmed, proceed to the next step.
2. Set the DIP switch address on the master battery to address 1, and all other batteries in parallel to differing addresses going in ascending order. (See image) →
3. Reset the battery BMS via the power button to register the address change.
4. Set up communication between the batteries via the “Battery-Comm” ports by using a CAT 5, 5e, or 6 cable.

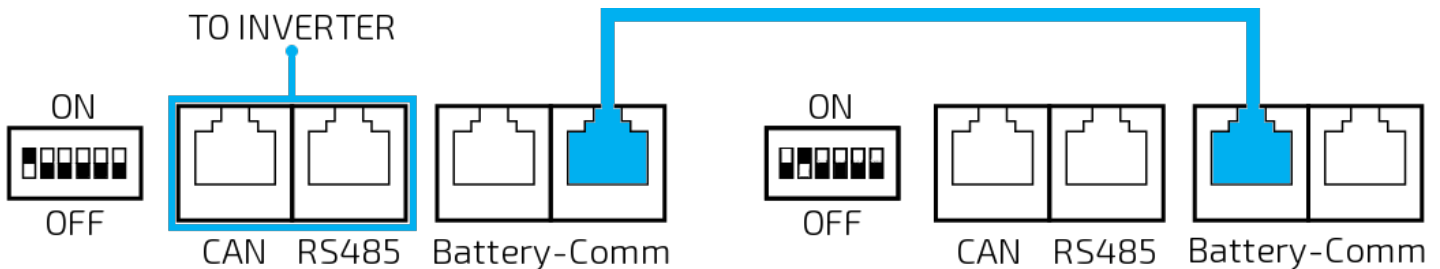

5. The battery set to address 1 will connect directly to the inverter BMS communication port via CAT 5, 5e or CAT 6 cable.

The image to the right shows a representation of the dip switch. The white represents the switches and how they should be set. →

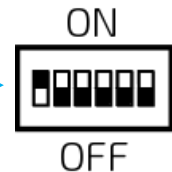

For additional examples of paralleling batteries, refer to the next page.



REMINDER:

The battery can charge/discharge up to 200A before the BMS shuts off the pack. Ensure the inverter is configured to handle this high of a current and size all wires accordingly! Refer to an NEC approved ampacity chart or consult with the installer or a solar electrician for more information.

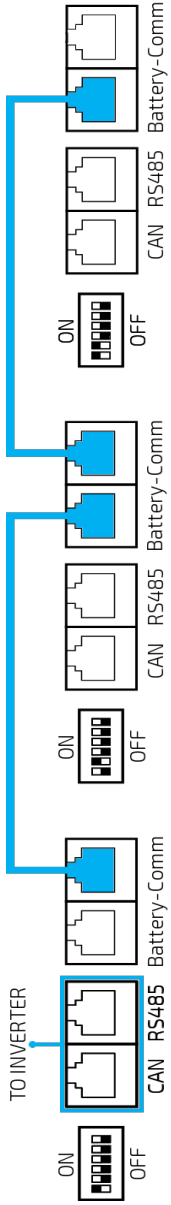

LifePower4 24V V2 in parallel

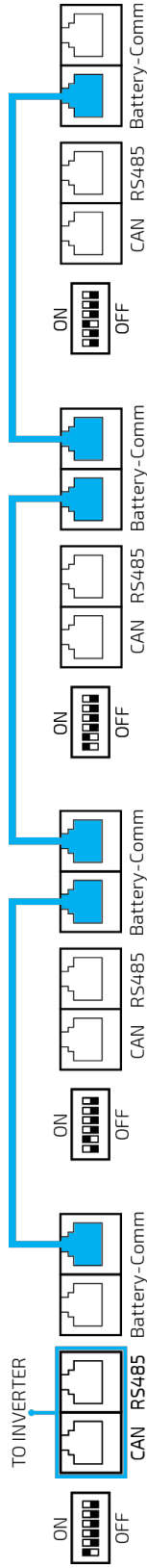

LifePower4 24V V2 in parallel

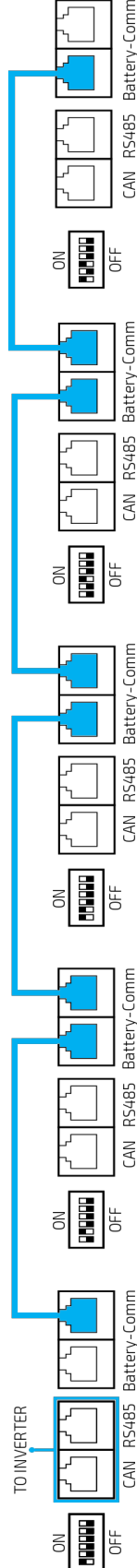

LifePower4 24V V2 in parallel

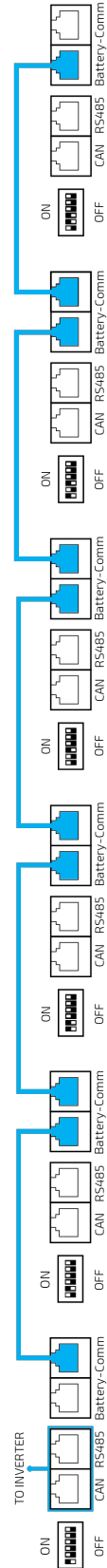

LifePower4 24V V2 in parallel

7. WARRANTY INFORMATION

For information regarding warranty registration on EG4® Electronics products, please navigate to <https://eg4electronics.com/warranty/> and select the corresponding product to begin the registration process.

8. CHANGELOG

Version 1.1.2

- Added French safety/dangers section

Version 1.1.1

- Modified warranty in section 6

Version 1.1

- Added P65 Warning to safety instructions
- Added additional certification logos to cover page

Version 1.0

- First version release



CONTACT US

support@eg4electronics.com

(903) 609-1988

www.eg4electronics.com