

User Manual

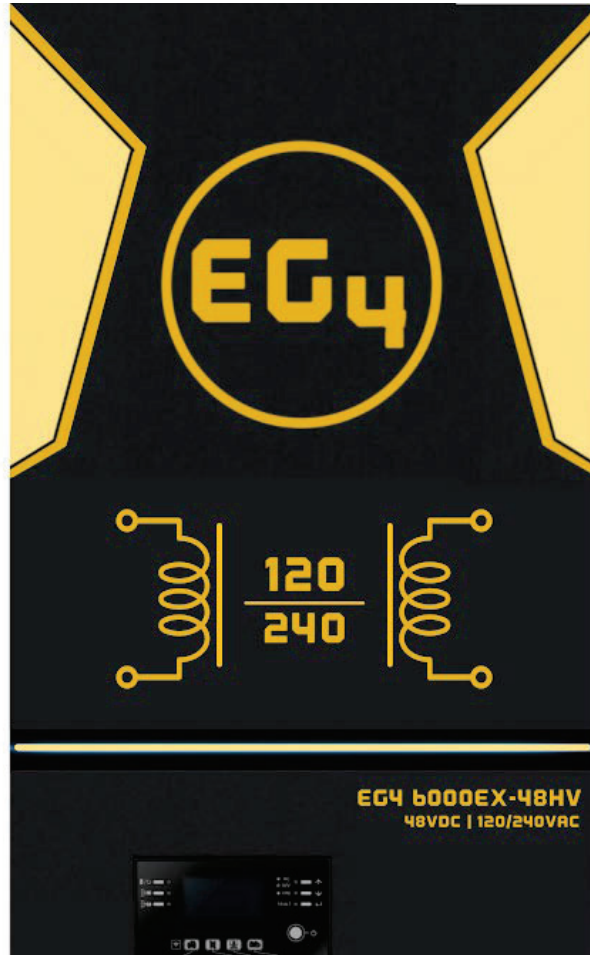

EG4 6000EX-48 INVERTER / CHARGER

Table Of Contents

ABOUT THIS MANUAL	1
Purpose	1
Scope	1
SAFETY INSTRUCTIONS	1
SPECIFICATIONS	2
INTRODUCTION	3
Product Overview	4
INSTALLATION	5
Unpacking and Inspection	5
Preparation	5
Mounting the Unit.....	5
Battery Connection	6
AC Input/Output Connection	7
PV Connection	8
Final Assembly	9
Communication Connection	10
Dry Contact Signal	10
OPERATION	11
Power ON/OFF	11
Operation and Display Panel.....	11
LCD Display Icons.....	12
LCD Setting	13
Display Setting	19
Operating Mode Description	24
PARALLEL FUNCTION	27
BMS Communication Install.....	32
BATTERY BASED COMMISSIONING GUIDE.....	36
TROUBLESHOOTING.....	38
WI-FI OPERATION GUIDE IN REMOTE PANEL	42
PARAMETER SETTING LIST	50

ABOUT THIS MANUAL

Purpose

This manual describes the assembly, installation, operation and troubleshooting of this unit. Please read this manual carefully before installation and operation. Please keep this manual for future reference.

Scope

This manual provides safety and installation guidelines as well as information on tools and wiring.

SAFETY INSTRUCTIONS



WARNING: This chapter contains important safety and operating instructions. Read and keep this manual for future reference.

1. Before installing or using the unit, read all instructions and cautionary markings on the unit, the batteries, and all appropriate sections of the manual.
2. **CAUTION-** Do not disassemble the unit. Take it to a qualified service center when service or repair is required. Incorrect re-assembly may result in a risk of electric shock or fire.
3. To reduce risk of electric shock, shutdown and disconnect all wiring and power inputs of any kind before attempting any maintenance or cleaning. Turning off the unit alone will not reduce the risk of shock or injury.
4. **CAUTION** - Only qualified Electrically trained personnel can install this equipment safely.
5. **NEVER** charge a battery below specified minimum temperature; refer to the battery data sheet.
6. Wire size is critical for safe operation, and optimal performance of the equipment. Refer to a accredited sizing resource or to cable manufacturer specifications to meet inverter/charge requirements.
7. Use caution when working with metal tools on or around all systems and batteries. Risk of electrical arcs and/or short circuiting of equipment can lead to severe injury and damage.
8. Strictly follow installation procedure when connecting and disconnecting AC or DC terminals. Refer to INSTALLATION section of the manual for details.
9. The internal overcurrent device is not a guarantee of battery protection. Size and install the correct DC breaker or fuse for the batteries if not included with the product.
10. **GROUNDING** -This inverter/charger should be connected to a permanent grounded wiring system. The grounding system must meet the Authority Having Jurisdiction (AHJ) requirements in your area.
11. **NEVER** short AC output and DC inputs. Do NOT connect to the grid with a shorted DC input.
12. **Warning!!** Only qualified service personnel are able to service this device. If errors still persist after following troubleshooting table, please contact your retailer for further assistance.
13. **WARNING:** Because this inverter is non-isolated, only three types of PV modules are acceptable: Monocrystalline, Polycrystalline with class A-rated, and CIGS modules. To avoid any malfunction, do not connect any PV modules with possible current leakage to the inverter. For example, grounded PV modules will cause current leakage to the inverter. When using CIGS modules, please be sure NOT to ground either PV+/- poles.
14. **CAUTION:** DC breakers and surge protection on PV lines are recommended. Without breakers the equipment is at higher risk of damage from sources such as surges and lighting strikes (which are not under warranty).

DISCLAIMER

EG4 reserves the right to make changes to the material herein at any time without notice. You may refer to the EG4 website at www.eg4electronics.com for the most updated version of our manual.

SPECIFICATIONS

MODEL	6KW
RATED OUPUT POWER	6000W
PV INPUT (DC)	
Max. PV Power	7500W
Max. Input voltage (Maximum PV open voltage)	500 VDC
Max Output DC Power MPPT range	277 VDC~480 VDC
Working MPP range	120 VDC~480 VDC
Max. DC Input current / Total array amps	27A
Number of MPP Trackers	1
GRID-TIE OPERATION (International Use Only)	
GRID OUTPUT (AC)	
Nominal Output Voltage	110-120VAC (L-N) / 220-240VAC (L1-L2)
Feed-in Grid Voltage Range	93.5~126.5 VAC For 110 Vac model 102~138 VAC For 120 Vac model
Feed-in Grid Frequency Range	57 Hz ~63 Hz
Nominal Output Current	27.3A (for 110VAC) 25A (for 120VAC)
Power Factor Range	>0.99
Maximum Conversion Efficiency (DC/AC)	95%
OFF-GRID, HYBRID OPERATION	
GRID INPUT	
Acceptable Input Voltage Range	65 - 140 VAC (Appliances) or 95 - 140 VAC (UPS)
Frequency Range	50 Hz/60 Hz (Auto sensing)
Rating of AC Transfer Relay	40A
BATTERY MODE OUTPUT (AC)	
Nominal Output Voltage	110-120VAC (L-N) / 220-240VAC (L1-L2)
Output Waveform	Pure Sine Wave
Efficiency (DC to AC)	93%
BATTERY & CHARGER	
Nominal DC Voltage	48 VDC
Maximum Charging Current (from Grid)	120A
Maximum Charging Current (from PV)	120A
Maximum Total Charging Current	120A
GENERAL	
Dimension, H X W X D	23-3/8" x 14-3/8" x 5-1/2" (593.6 x 365 x 138.4 mm)
Net Weight	79 lbs. (35 kgs)
INTERFACE	
Parallel	Yes, Up to 9
Communication	RS232/Dry-Contact/Wi-Fi
ENVIRONMENT	
Humidity	0 ~ 90% RH (No condensing)
Operating Temperature	14°F to 122°F (-10°C to 50°C)

INTRODUCTION

This is a residential self-consumption multi-function inverter, combining the functions of an inverter, solar charge controller, and battery charger to offer uninterrupted power system in a single package. The comprehensive LCD display offers user-configurable and easily-accessible button operations such as battery charging current, AC or solar charging priority, and acceptable input voltage based on different applications.

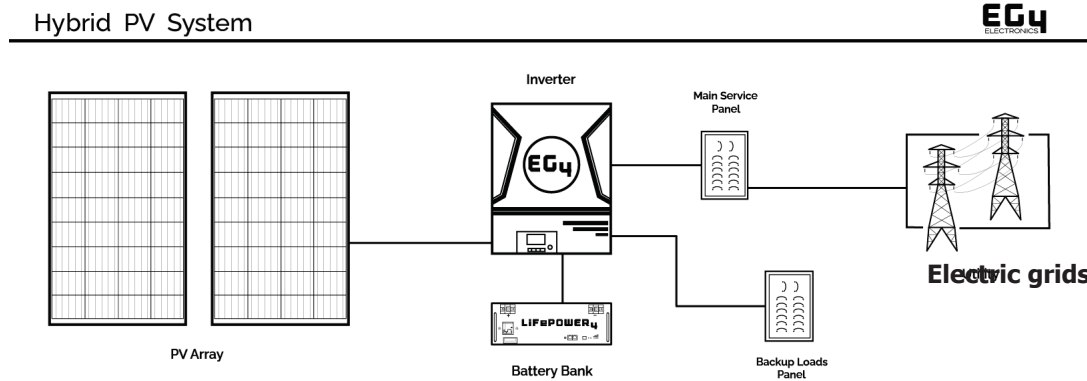

Figure 1 Basic hybrid PV System Overview

Depending on different power situations, this hybrid inverter is designed to manage power from PV modules (solar panels), battery bank, and the utility or generator AC input. When MPP input voltage of PV modules is within acceptable range (see specification for the details), this inverter is able to charge the battery.

NOTE: Never connect the positive or negative poles of the solar equipment to ground.

NOTE: This inverter is only compatible with 240V Split-phase grid or generator input. The voltage between Line 1 and Line 2 is equal to Line 1 to Neutral plus Line 2 to Neutral. The equipment does not support single-phase or three-phase input or output.

The phase angle between L1 and L2 is 180°.

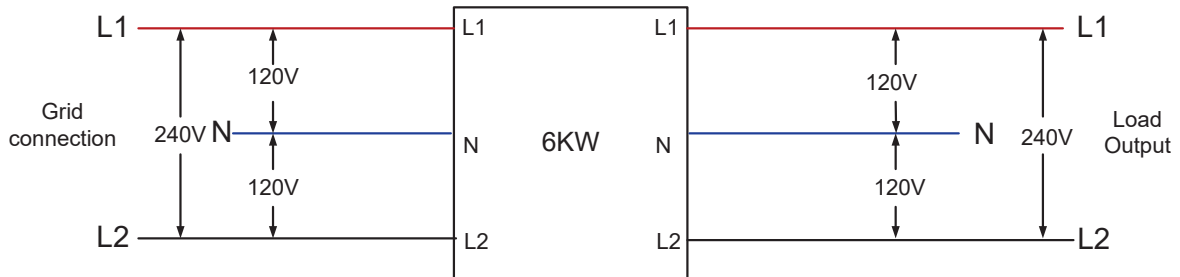

Product Overview

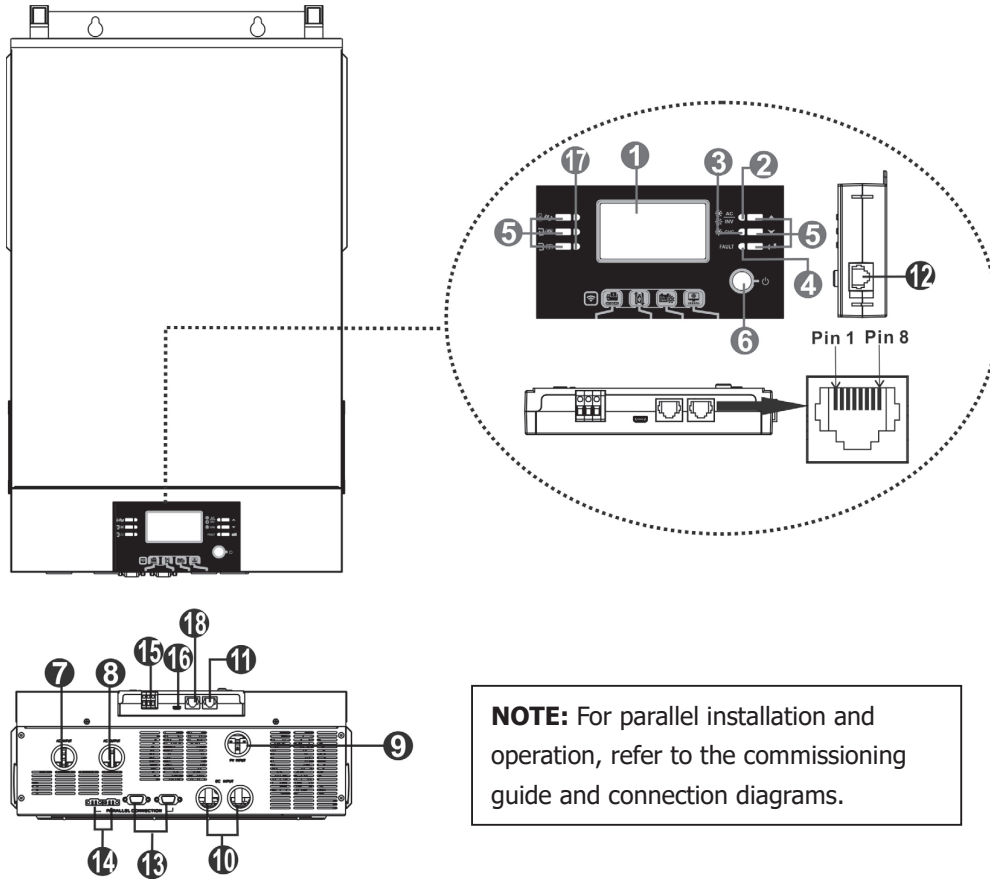

NOTE: For parallel installation and operation, refer to the commissioning guide and connection diagrams.

1. LCD display
2. Status indicator
3. Charging indicator
4. Fault indicator
5. Function buttons
6. Power on/off switch
7. AC input connectors
8. AC output connectors (Load connection)
9. PV connections
10. Battery connections
11. RS-232 communication port
12. Remote LCD panel communication port
13. Parallel communication port (only for use in parallel setups)
14. Current sharing port (only for parallel model)
15. Dry contact
16. USB communication port
17. LED indicators for USB function setting / Output source priority timer / Charger source priority setting
18. BMS communication port (RS-485)

INSTALLATION

Unpacking and Inspection

Before installation, please inspect the unit. Be sure nothing inside the package is damaged. Check to ensure the following items are included with each inverter:

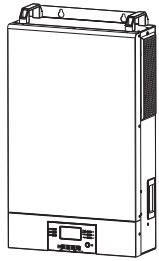

Inverter unit



Software CD



Manual



RS-232 Cable

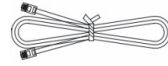

Battery Comms Cable



Parallel Cables

Preparation

To prepare for the wiring step of installation, remove the bottom cover as shown below.

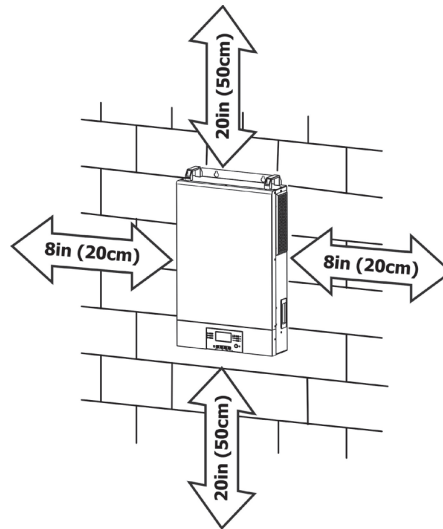
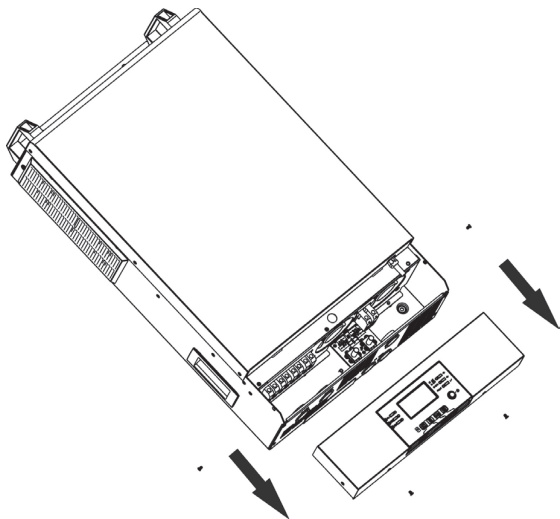

Mounting the Unit

Consider the following points before selecting a location for installation:

- Avoid mounting the inverter on combustible construction materials. Masonry or fire-resistant surfaces for mounting are recommended.
- Mount on a solid surface or appropriate strut/frame.
- Install this inverter at the operator's eye level in order to allow the LCD display to be read at all times.
- The ambient temperature should be between 14°F(-10°C) and 122°F(50°C) to ensure optimal operation.
- Install the inverter vertically and follow local AHJ requirements for equipment clearances.
- Ensure enough clearance based on the diagram above for proper cooling/ventilation.



SUITABLE FOR MOUNTING ON CONCRETE OR OTHER NON-COMBUSTIBLE SURFACES ONLY.

Mounting the Inverter

Install the unit using all three screw holes. Use #8 (M4) or #10 (M5) screws.

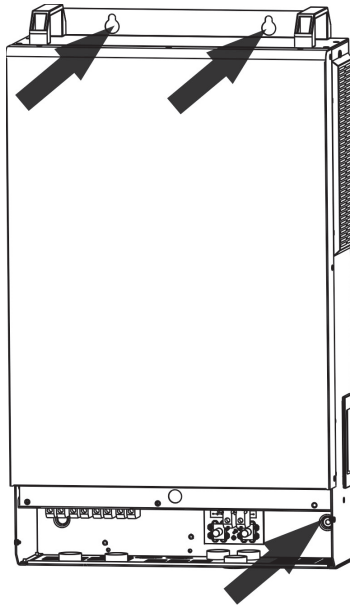

Battery Connection

CAUTION: For safe operation and regulation compliance, it is required to install a separate DC over-current protector or disconnect device between battery and inverter. It may not be required to have a disconnect device in some applications, however, you are required to have over-current protection installed. Please refer to typical amperage in the below table for required fuse or breaker size.

WARNING! All wiring must be performed by electrically trained personnel
WARNING! It's critically important for system safety and efficient operation to use appropriate cable sizes for battery connections. To reduce risk of injury, please use the proper recommended cable and terminal sizes below.

Ring terminal:

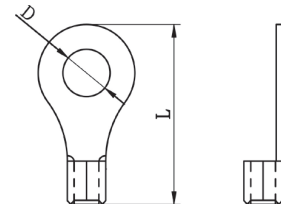

Recommended battery cable and terminal size:

Model	Typical Amperage	Minimum Battery Capacity	Wire Size	Ring Terminal			Torque Value
				Min size	Dimensions		
					D (mm)	L (mm)	
6KW	137A	300AH	2AWG	2AWG/ 38mm ²	M10 13mm nut	39	~ (2-3 Nm)

Please follow below steps to implement battery connection:

1. Assemble battery ring terminal based on recommended battery cable and terminal size.
2. Insert the ring terminal of battery cable flatly into battery connector of inverter and make sure the nuts are tightened with a torque of 17-27 in-lbs/ 2-3 Nm. Make sure polarity at both the battery and the inverter/ charger is correctly connected and ring terminals are tightly screwed to the battery terminals.

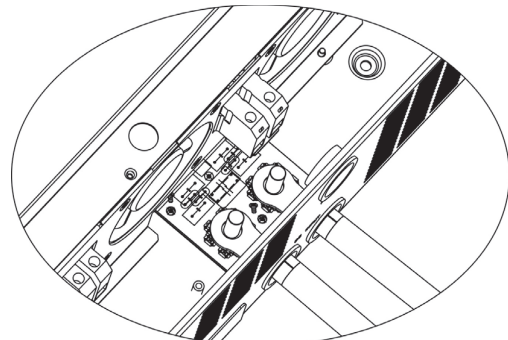



WARNING: Shock Hazard

Installation must be performed carefully; arc and shock hazards are present.



CAUTION! Do not place anything between the flat part of the inverter terminal and the ring terminal. Mixed materials, gaps, and loose connections can all lead to overheating.

CAUTION! Do not apply anti-oxidant substance on the terminals before terminals are connected.

CAUTION! Before connecting the DC circuit, ensure proper polarity of the system. Ensure the positive (+) terminal of the inverter is properly connected to the battery, and disconnect/fusing or breaker, as well as the polarity of the negative (-) connections.

AC Input/Output Connection

CAUTION! Before connecting to AC input power source, install a **separate** AC breaker (40A max) between inverter and AC input power source. Ensure the input breaker and conductor ratings match. Installation of a breaker on the AC input is required for OCP and means of disconnect. Check with your AHJ and ensure correct system design for regulatory compliance.

CAUTION! There are two sets of terminal blocks, one for input and the other for output. While the terminals are marked "IN" and "OUT", double check to ensure wires throughout the system are connected and phased correctly. Use fine stranded 90C rated wiring of the correct type based on code requirements.

WARNING! All wiring must be performed by qualified personnel. Follow the requirements of your local AHJ.

WARNING! For all AC wiring, proper sizing is required. Refer to the wire type and ampacity calculations required by the specific design, site, and local regulatory requirements. To reduce risk of injury and damage to equipment, please use the minimum recommended cable size as below.

Suggested minimum cable requirement for AC wiring:

Model	Gauge	Terminal Torque Value
6KW	10 AWG	~10-14 in-lbs (1.2-1.6 Nm)

Please follow the below steps to implement AC input/output connection:

1. Before making AC input/output connection, disconnect all DC sources of energy.
2. Remove ~7/16" (10mm) of insulation from all eight wires (L1, N, L2, G).
3. Insert AC input wires according to labeling on the terminal blocks and tighten the terminal screws. Be sure to connect the grounding conductor (⊕) first.



→ **Ground (Green or Green with Yellow stripe)**

L1 → **Line (Black)**

L2 → **Line (Red)**

N → **Neutral (White or Gray)**

Note: Cord grips, conduit, or other approved methods of securing wires must be used.

Note: Wire colors may vary.

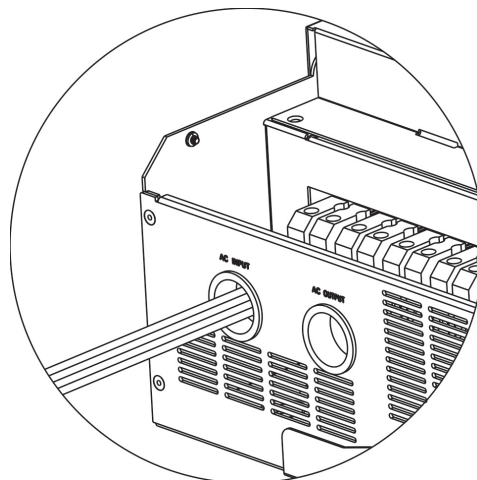

**WARNING:**

Ensure all AC power sources and loads are disconnected before wiring the unit.

4. Insert the AC output wires according to labeling on the terminal block and tighten terminal screws. Be sure to connect the grounding conductor (⊕) first.



→ **Ground (Green or Green with a Yellow stripe)**

L1 → **Line 1 (Black)**

L2 → **Line 2 (Red)**

N → **Neutral (White or Gray)**

Note: Cord grips or other approved methods of securing wires must be used.

Note: Wire colors may vary.

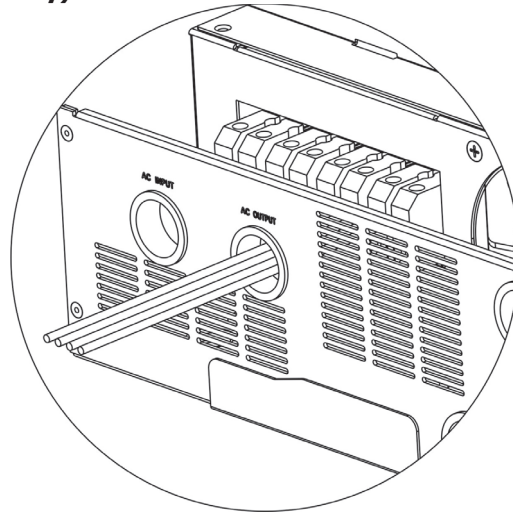

5. Make sure the wires are securely connected, and use required cord grips or conduit.

CAUTION: Important

Connect AC wire to correct terminals. If either Line 1 or 2 are reversed with Ground/Neutral it will cause a short-circuit and damage the equipment and loads connected to the system.

CAUTION: Appliances with heavy start and run demands, such as air conditioners, require special consideration. For many air conditioners for example, at least 2~3 minutes to restart might be required to allow enough time to balance refrigerant gases. If a power outage occurs and recovers in a short time, it may cause damage to the connected appliances. To prevent damage, please check with the manufacturer of the appliance to see if it is equipped with a time-delay function or soft-start feature before installation. Overload of the inverter/charger may trigger a fault leading to a sudden loss of AC output power, which may cause damage to appliances with motors/compressors.

PV Connection

CAUTION: Before connecting to PV modules/strings, install **separate** DC circuit breakers or a means of disconnect paired with properly sized fuses between inverter and PV modules/strings. DO NOT work with or connect live PV conductors to the unit EVER. Ensure all exposed conductors are safely disconnected from the power source.

NOTE: Use 600V/30A rated circuit breakers. DC rated breakers must be used. The over voltage category of the PV input is II. Please Follow the steps below to complete PV connections.

WARNING! All wiring must be performed by qualified personnel.

WARNING: Making connections with live a PV source will damage the inverter!

WARNING! It's very important for system safety and efficient operation to use appropriate cables for PV module connection. To reduce risk of injury, use the proper recommended cable size below.

CAUTION: It is required to use a PV surge protection device. Damage to the inverter can occur from surges such as lightning or short circuits.

Model	Typical Amperage	Cable Size	Torque
6KW	27A	10AWG	~17-21 in-lbs (-2.0-2.4Nm)

PV Module Selection:

1. Open Circuit Voltage (Voc) of the PV modules/strings must not exceed the unit's maximum rating. Voc must be calculated including the environmental impacts, such as temperature in accordance to the module manufacturer's data sheet and reliable weather data for the installation location.
2. Voltage at Maximum Power (Vmp) of PV strings must be higher than the start-up voltage of the inverter.

WARNING: Exceeding the maximum input voltage will destroy the unit!

Solar Charging Mode	
INVERTER MODEL	6KW
Max. PV Array Open Circuit Voltage	500 Vdc
PV Array MPPT Voltage Range	120-480Vdc
MPP Number	1

Follow the below steps to complete PV connection:

1. Remove 10 mm (3/8in) of insulation from positive and negative conductors.
2. Check for correct polarity of connections at the PV inputs at the disconnect, with the disconnecting means off to ensure the exposed output in not live. Connect the positive pole (+) of the PV source to the positive pole (+) of PV input terminal. Connect the negative pole (-) of the PV source to the negative pole (-) of the PV input terminal. Tighten the terminals.

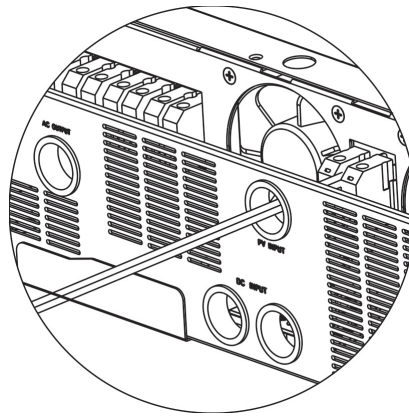
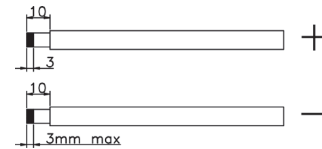

NOTE: Cord grips or Conduit must be used.

Final Assembly

After connecting all wiring, please put the bottom cover back by screwing four screws as shown below. **This cover is critical for safe use of this device as LETHAL voltages occur behind it.**

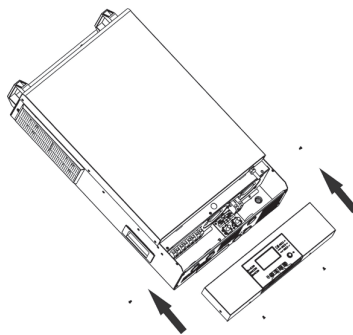

Communication Connection

Serial Connection

Please use the supplied communication cable to connect to inverter and PC. Insert the bundled CD into a computer and follow the on-screen instructions to install the monitoring software. For the detailed software operation instructions, please check the user manual of the software stored on the CD.

Wi-Fi Connection

Wi-Fi module can enable wireless communication between off-grid inverters and the cloud monitoring platform. Users have complete remote monitoring and control capacity for inverters when combining the Wi-Fi module with the SolarPower APP, available for both iOS and Android based device. All data loggers and parameters are saved in the cloud. Refer to Appendix IV for detailed operation.

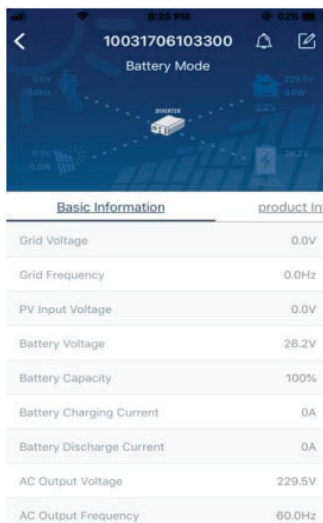

Dry Contact Signal

There is one dry contact (3A/250VAC) available on the rear panel. It could be used to deliver a signal to an external device when battery voltage reaches a warning level.

Unit Status	Condition		Dry contact port: 		
			NC & C	NO & C	
Power Off	Unit is off and no output is powered.		Close	Open	
Power On	Output is powered from Utility.		Close	Open	
	Output is powered from Battery or Solar.	Program 01 set as SUB	Battery voltage < Low DC warning voltage	Open	Close
			Battery voltage > Setting value in Program 21 or battery charging reaches floating stage	Close	Open
	Output is powered from Battery or Solar.	Program 01 is set as SBU	Battery voltage < Setting value in Program 20	Open	Close
Battery voltage > Setting value in Program 21 or battery charging reaches floating stage			Close	Open	

OPERATION

Power ON/OFF

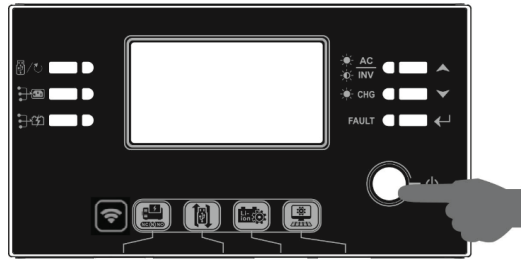

After completing installation of the unit, the next step is powering on for setup. Start by pressing the On/Off switch (located on display unit) to power on the system.

Operation and Display Panel



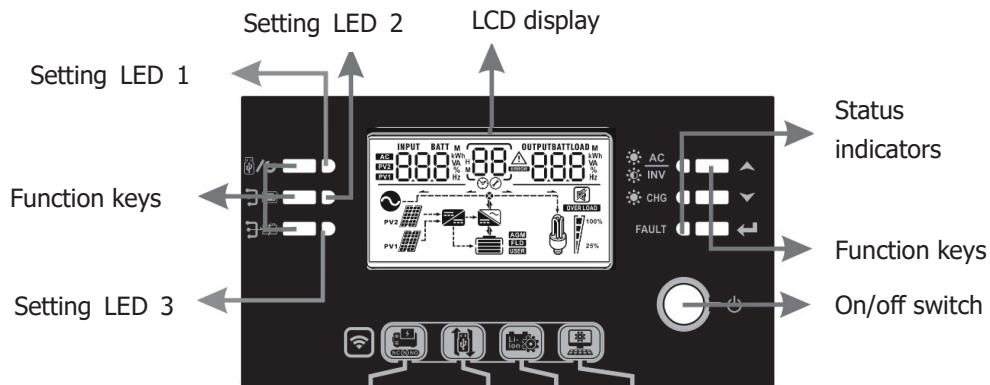



Refer to the diagram and table below for details on the operation and display panel. There are three indicators, four function keys, and an LCD display.



LED Indicators







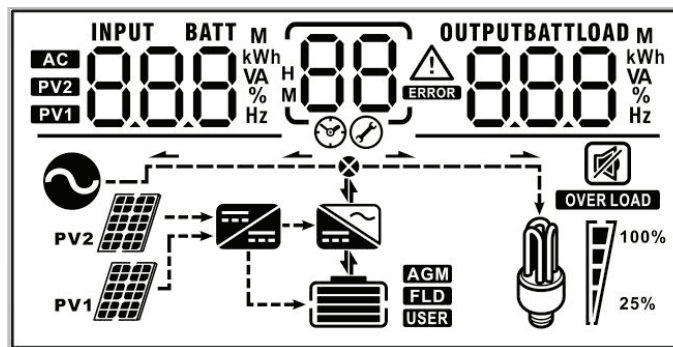

LED Indicator			Messages
Setting LED1	Green	Solid On	Reserved for future features
Setting LED2	Green	Solid On	Reserved for future features
Setting LED3	Green	Solid On	Reserved for future features
Status Indicator		Solid On	Output is powered by utility in Line mode.
		Flashing	Output is powered by battery or PV in battery mode.
		Solid On	Battery is fully charged
		Flashing	Battery is charging.
	FAULT	Solid On	Fault mode
Flashing		Warning mode	



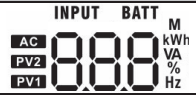

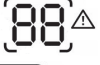



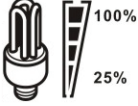

Function Keys

Function Key	Description
	ESC Exit the setting/go back
	Reserved
	Reserved
	Up Scroll to previous selection
	Down Scroll to next selection
	Enter To confirm/enter the selection in setting mode

LCD Display Icons



Icon	Function
Input source information	
	Indicates AC input information is being displayed
	Indicates PV1 input information is being displayed (PV2 not used)
Left digital display information	
	Indicates input voltage, input frequency, battery voltage, PV voltage, charger current
Middle digital display information	
	Indicates the setting when cycling through options.
	Indicates the warning and fault codes. Warning: Flashing  with warning code Fault: display  with fault code
Right digital display information	
	Displays the output voltage, output frequency, load percent, load VA, load W, PV charger power, DC discharging current based on current unit being displayed and cycled through.
Battery information	
	Displays battery state of charge (SOC) by ranges from 0-24%, 25-49%, 50-74%, and 75-100% per bar, and charging status.

Load information					
		Indicates output overload.			
		Indicates the load level by 0-24%, 25-49%, 50-74%, and 75-100%.			
		0%~24%	25%~49%	50%~74%	75%~100%
					
Mode operation information					
		Indicates connection to an AC input source.			
		Indicates connection of the PV array.			
		Indicates solar is being used to charge the battery bank.			
		Indicates the DC/AC inversion is working.			
Mute operation					
		Alarm is disabled. Warning: Will not signal a fault when disabled!			





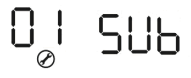
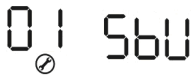



LCD Setting

After pressing and holding ENTER button for 3 seconds, the unit will enter setting mode. Press "UP" or "DOWN" buttons to select setting programs. Then, press the "ENTER" button to confirm the selection or the ESC button to exit.





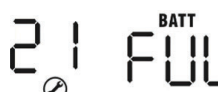



Program	Description	Selectable option	
00	Exit setting menu	Escape 	
01	Output source priority selection	SUB (Default) 	Solar energy provides power to the loads as first priority. If solar energy is not sufficient to power all connected loads, Utility energy will supply power to the loads at the same time.
		SBU 	Solar energy provides power to the loads as first priority. If solar energy is not sufficient to power all connected loads, battery energy will supply power to the loads at the same time. Utility provides power to the loads only when battery voltage drops to either low-level warning voltage or the setting point in program 20, or if solar and battery is not sufficient.

02	AC input voltage range	Appliances (Default setting) 02 APL ⊗	If selected, acceptable AC input voltage range will be set to 65-140VAC.
		UPS 02 UPS ⊗	If selected, acceptable AC input voltage range will be set to 95-140VAC.
03	Output voltage	110Vac 03 110 v ⊗	120V (Default setting) 03 120 v ⊗
04	Output frequency	50Hz 04 50 Hz ⊗	60Hz (Default setting) 04 60 Hz ⊗
05	Solar supply priority	Available power will charge battery first (default setting) 05 bLU ⊗	Solar energy provides power to charge battery as first priority.
		Power supplies the loads first 05 LbU ⊗	Solar energy provides power to the loads as first priority.
06	Overload bypass: When enabled, the unit will transfer to line mode if overload occurs in battery mode.	Bypass disabled 06 byd ⊗	Bypass enable (default setting) 06 byE ⊗
07	Auto restart when overload occurs	Restart disable (default setting) 07 Lfd ⊗	Restart enabled 07 LfE ⊗
08	Auto restart when over temperature occurs	Restart disable (default setting) 08 tfd ⊗	Restart enabled 08 tFE ⊗
09	Solar energy feed to grid configuration WARNING: THIS SETTING IS NOT CERTIFIED FOR THE UNITED STATES, ALWAYS GET SPECIFIC PERMISSION FROM YOUR UTILITY AND AHJ TO OPERATE THIS MODE	Feed to grid disable (default setting) 09 Gfd ⊗	Solar energy back-feed to grid disable.
		Feed to grid enable 09 GfE ⊗	Solar energy back-feed to grid enable.

10	Charger source priority: Configure battery charger source priority	If this inverter/charger is working in Line, Standby or Fault mode, charger source can be programmed as below:	
		Solar first 10 C50	Solar energy will charge battery as first priority. Utility/AC input will charge battery only when solar energy is not available.
		Solar and Utility (default) 10 SNU	Solar energy and utility/AC input will charge battery at the same time.
		Solar only 10 050	Solar energy will be the only charger source, even when utility/AC input power is available.
		If this inverter/charger is working in Battery mode, only solar energy can charge the battery. Solar energy will charge battery if it's available and sufficient.	
11	Maximum charging current: To configure total charging current for solar and utility chargers. (Max charging current = utility/AC input charging current + solar charging current)	60A (default setting) 120A is needed for 7.5kW PV capacity 11 60 ^A	The setting range is from 10A to 120A. Each click is a 10A increment.
13	Maximum utility/AC input charging current	30A (default setting) 13 30 ^A	The setting range is from 10A to 120A. Each click is a 10A increment.
14	Battery type	AGM (default) 14 AGn	Flooded 14 FLd
		User-Defined 14 USE	If "User-Defined" is selected, battery charge voltage and low DC cut-off voltage can be set up in program 17, 18 and 19.
		EG4 14 EG4	If this is selected, programs 11, 17, 18 and 19 will be automatically set up. Please contact the battery supplier for installation procedure.

		LiB-protocol 	Select " LiB" if using Lithium battery compatible to Lib protocol. If selected, programs of 11, 17, 18 and 19 will be automatically set up. No need for further setting.
		3 rd party Lithium battery 	If selected, programs of 11, 17, 18 and 19 will be automatically set up. Please contact the battery supplier for installation procedure.
17	Bulk charging voltage (C.V voltage)	Default setting: 56.4V 	If self-defined is selected in program 14, this program can be set up. Setting range is from 48.0V to 64.0V. Each click is an increment of 0.1V.
18	Float charge voltage	Default setting: 54.0V 	If self-defined is selected in program 14, this program can be set up. Setting range is from 48.0V to 64.0V. Each click is an increment of 0.1V.
19	Low DC cut off battery voltage setting	Default setting: 40.8V 	If self-defined is selected in program 14, this program can be set up. Setting range is from 40.8V to 48.0V. Each click is an increment of 0.1V. Low DC cut-off voltage will be fixed to setting value no matter what percentage of load is
20	Bypass loads to grid when grid is present.	connected. default setting: 46V 	Setting range is from 44V to 51V and each click is an increment of 1V. In EG4 Mode you will see a percentage instead
21	Set point for transfer back to off-grid operation if system is bypassed based on 20	Battery fully charged 	The setting range is from 48V to 58V, Each click is an increment of 1V. In EG4 Mode you will see a percentage instead
		Default setting: 54V 	

22	Auto return to default display screen	Return to default display screen (default) 22 ESP	If selected, no matter how users switch display screen, it will automatically return to default display screen (Input voltage /output voltage) after no button is pressed for 1 minute.
		Stay at latest screen 22 FEP	If selected, the display screen will stay at latest screen user selects (good for keeping your favorite view up)
23	Backlight control	Backlight on (default) 23 LON	Backlight off 23 LOF
24	Alarm control	Alarm on (default setting) 24 BON	Alarm off 24 BOF
25	Beeps while primary power source is interrupted/faults	Alarm on (default setting) 25 AON	Alarm off 25 AOF
26	AC coupling (may require firmware update not available at release date of this model)	Enable 26 ACE	Disable 26 ACD
27	Record Fault codes (this is best to enable)	Record enabled (default) 27 FEN	Record disable 27 FDS
28	AC output mode *This setting is only available when the inverter is in standby mode (Switch off).	Single: When selected, the unit is used in standalone operation. 28 ^{OUTPUT} SIO	Parallel: When selected, Parallel stacking of up to 9 units is enabled 28 ^{OUTPUT} PAL
29	Reset PV energy storage kwh history	Not reset (default setting) 29 NHT	Reset 29 FSE



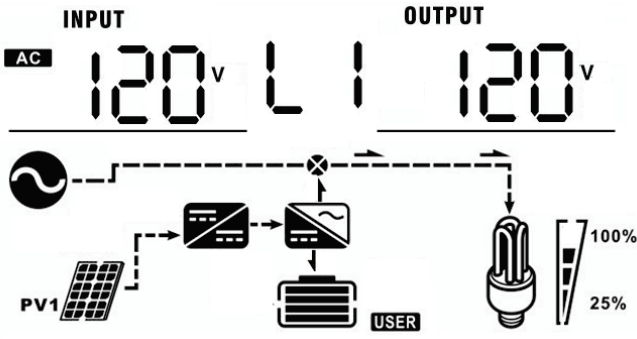
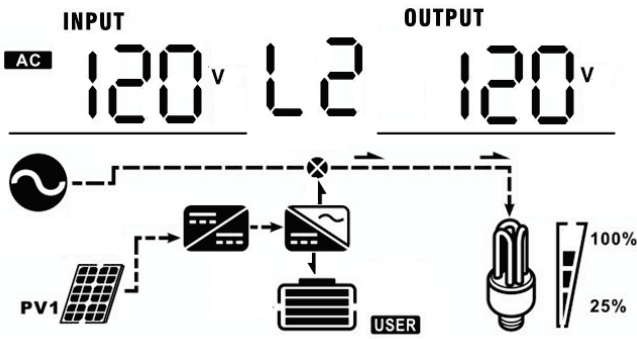
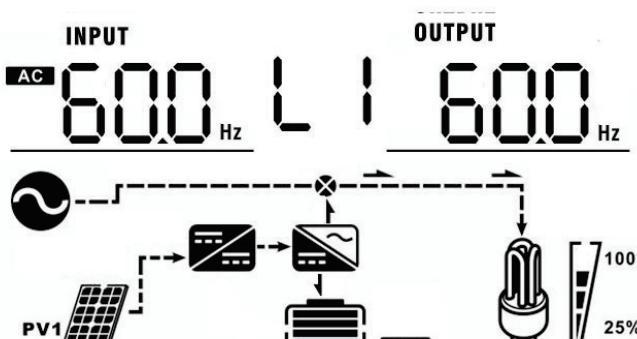

30	Scheduled Start charging time for AC charger	<p>00:00 (default setting)</p>  <p>The setting range of starting time for the AC charger is from 00:00 to 23:00, each click is 1 hour.</p>
31	Scheduled Stop charging time for AC charger	<p>00:00 (default setting)</p>  <p>The setting range of stop charging time for AC charger is from 00:00 to 23:00, each click is 1 hour.</p>
32	Scheduled time for AC output on	<p>00:00 (default setting)</p>  <p>The setting range of scheduled time for AC output on is from 00:00 to 23:00, each click is 1 hour.</p>
33	Scheduled time for AC output off	<p>00:00 (default setting)</p>  <p>The setting range of scheduled time for AC output off is from 00:00 to 23:00, each click is 1 hour.</p>
95	Current time setting – Minute	 <p>For minute setting, the range is from 00 to 59.</p>
96	Current time setting – Hour	 <p>For hour setting, the range is from 00 to 23.</p>
97	Current time setting– Day	 <p>For day setting, the range is from 00 to 31.</p>
98	Current time setting– Month	 <p>For month setting, the range is from 01 to 12.</p>
99	Current time setting – Year	 <p>For year setting, the range is from 16 to 99.</p>

Display Setting





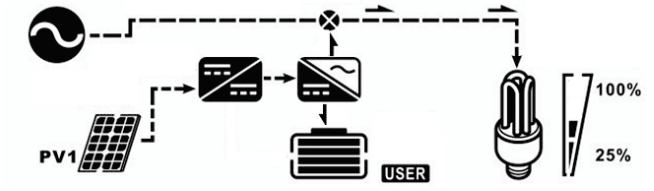

The LCD display information is cycled through by pressing "UP" or "DOWN" keys. The selectable information is switched as below order: input voltage, input frequency, PV voltage, charging current, battery voltage, output voltage, output frequency, load percentage, load in watts, load in VA, load in watts, DC discharging current, main board firmware version and SCC firmware version.

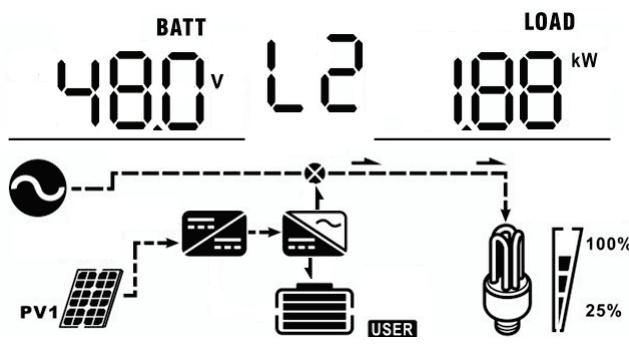
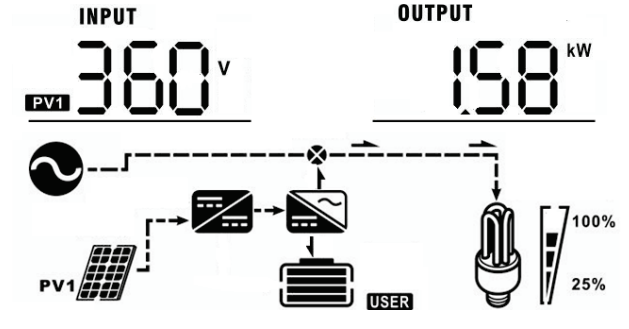
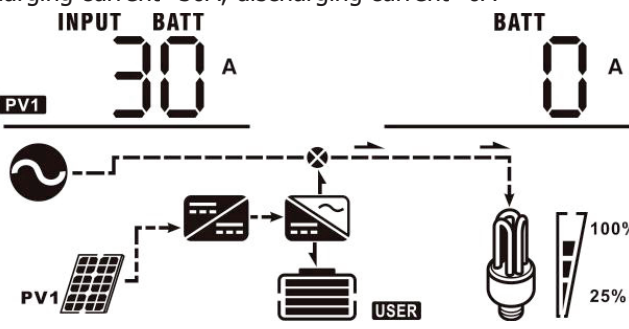
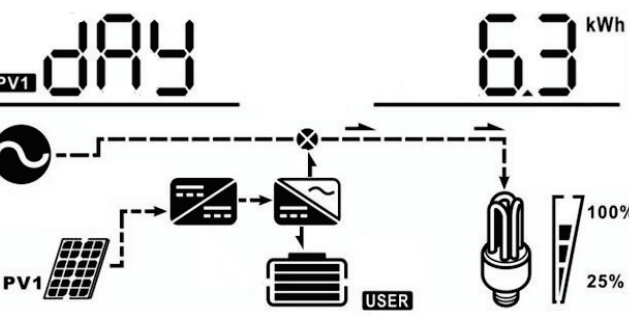
Select item	LCD display
Input 1 voltage and output 1 voltage (Default display screen)	<p>Input 1 Voltage=120V, output 1 voltage=120V</p> 
Input 2 voltage and output 2 voltage (Default display screen)	<p>Input 2 Voltage=120V, output 2 voltage=120V</p> 
Input 1 frequency and output 1 frequency	<p>Input 1 frequency=60.0Hz, output 1 frequency=60.0Hz</p> 

<p>Input 2 frequency and output 2 frequency</p>	<p>Input 2 frequency=60.0Hz, output 2 frequency=60.0Hz</p>
<p>Battery voltage and output 1 voltage</p>	<p>Battery Voltage=48.0V, output 1 voltage=120V</p>
<p>Battery voltage and output 2 voltage</p>	<p>Battery Voltage=48.0V, output 2 voltage=120V</p>
<p>Battery voltage and load 1 percentage</p>	<p>Battery Voltage=48.0V, load 1 percentage = 68%</p>

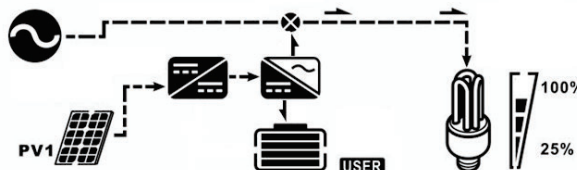

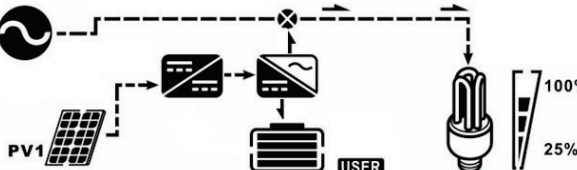
<p>Battery voltage and load 2 percentage</p>	<p>Battery Voltage=48.0V, load 2 percentage = 68%</p> <div style="text-align: center;"> <p>BATT LOAD</p> <p>480_v L2 68 %</p> </div> 
<p>Battery voltage and load 1 in VA</p>	<p>Battery Voltage=48.0V, load 1 in VA=1.08kVA</p> <div style="text-align: center;"> <p>BATT LOAD</p> <p>480_v L1 108^k VA</p> </div> 
<p>Battery voltage and load 2 in VA</p>	<p>Battery Voltage=48.0V, load 2 in VA=1.08kVA</p> <div style="text-align: center;"> <p>BATT LOAD</p> <p>480_v L2 108^k VA</p> </div> 
<p>Battery voltage and load 1 in watts</p>	<p>Battery Voltage=48.0V, load 1 in Watt=1.88kW</p> <div style="text-align: center;"> <p>BATT LOAD</p> <p>480_v L1 188^{kW}</p> </div> 



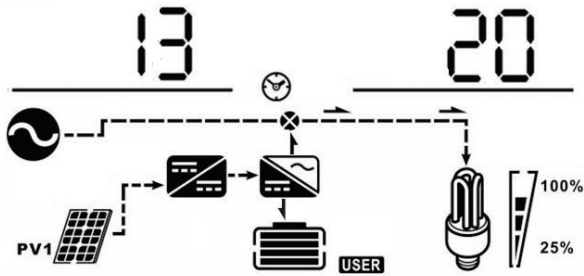
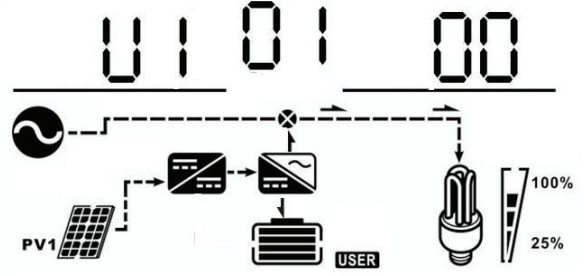
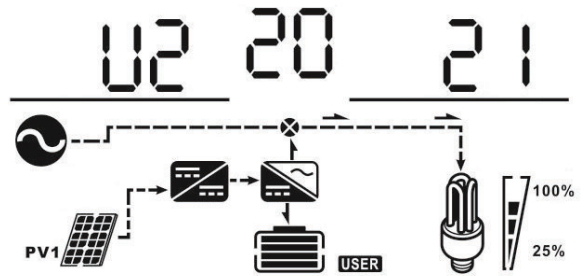

<p>Battery voltage and load 2 in watts</p>	<p>Battery Voltage=48.0V, load 2 in Watt=1.88kW</p> 
<p>PV1 voltage and PV power</p>	<p>PV1 Voltage=360V, PV power=1.58kW</p> 
<p>Charger current and DC discharging current</p>	<p>Charging current=30A, discharging current=0A</p> 
<p>PV energy generated today</p>	<p>Daily production example = 6.3kWh</p> 

<p>PV energy generated this month</p>	<p>Monthly energy example = 358kWh</p>  <p>358 kWh</p> 
<p>PV energy generated this year</p>	<p>Yearly energy example = 8.32MWh</p>  <p>8.32 MWh</p> 
<p>Lifetime PV energy generated</p>	<p>Total energy example = 13.9MWh</p>  <p>13.9 MWh</p> 
<p>Date</p>	<p>Date example Nov 28, 2016.</p>  <p>16 11 28</p> 

<p>Time (24HR format)</p>	<p>Time example 13:20.</p> 
<p>Main CPU version checking.</p>	<p>Main CPU version 00001.00</p> 
<p>Secondary CPU version checking.</p>	<p>Secondary CPU version 00020.21</p> 

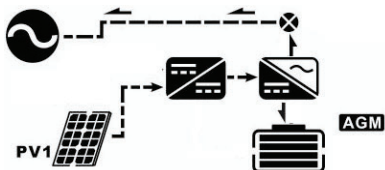
Operating Mode Description

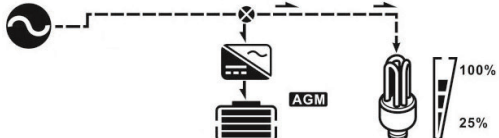
Operating mode	Behaviors	LCD display
<p>Standby mode</p> <p>Note:</p> <p>*Standby mode: The inverter is not turned on yet but at this time, the inverter can charge battery without AC output.</p>	<p>No output power, solar or utility charger available</p>	<p>The battery is charging using utility/AC input power.</p>  <p>The battery is charging using PV energy.</p>  <p>The battery is charged using utility/AC input and PV energy.</p> 

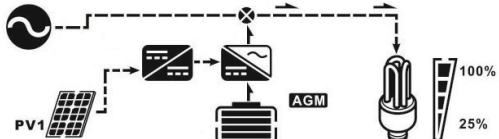
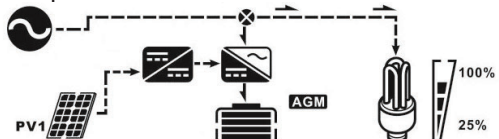
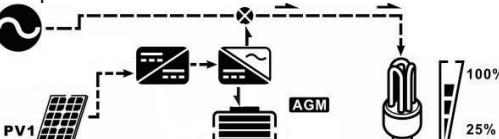
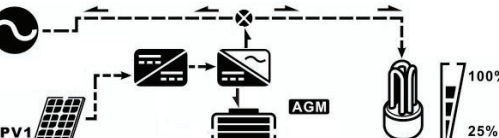
		<p>Battery is charged by PV energy and feed PV energy to grid.</p> 
		<p>The battery is not charging.</p> 
Line mode	Output power from utility. Charger available	<p>Utility charges battery and provides power to load.</p> 
		<p>Utility and battery power provide power to load.</p> 
Line mode	Output power from utility. Charger available	<p>PV energy, battery power and utility provide power to load.</p> 
		<p>PV energy and utility charge battery, and utility provides power to load.</p> 
	Output power from utility. Charger available	<p>PV energy charges battery, utility and PV energy provide power to the load.</p> 
		<p>PV energy is charging the battery, PV energy provides power to the load and feeds remaining energy to the grid.</p> 

Battery mode	Output power from battery or PV	<p>PV energy and the battery are supplying power to the loads.</p>
		<p>PV energy is charging the battery and providing power to the loads.</p>
		<p>The battery is providing power to the loads.</p>
Only PV mode	Output power from PV	<p>PV energy is providing power to the loads.</p>
<p>Fault mode</p> <p>Note: *Fault mode: Errors are caused by inside circuit error or external reasons such as over temperature, output short circuited and so on.</p>	No output, no charging.	<p>The battery is not charging.</p>

Parallel Function

1. Introduction

This inverter can be used in parallel in only split phase systems. A maximum of nine units can parallel together. The supported maximum output power is 54kW/54KVA.

*If you want to use only one breaker at the battery side for the whole system, the rating of the breaker should be X times current of 1 unit. "X" indicates the number of inverters connected in parallel.

Note: Use a 40A 2 Pole AC breaker for only 1 unit and install one breaker for the AC input in each inverter.

Recommended Battery Capacity

Inverters in parallel	2	3	4	5	6	7	8	9
Battery Capacity (48V)	500AH	700AH	1000AH	1200AH	1400AH	1700AH	1900AH	2100AH

2. Parallel Operation

Two inverters in parallel:

WARNING: Current sharing cables must be connected properly based on the below diagrams. Current sharing cables are shown in green, dashed lines. Improper connections and setup of these cables will result in damage.

Power Connection

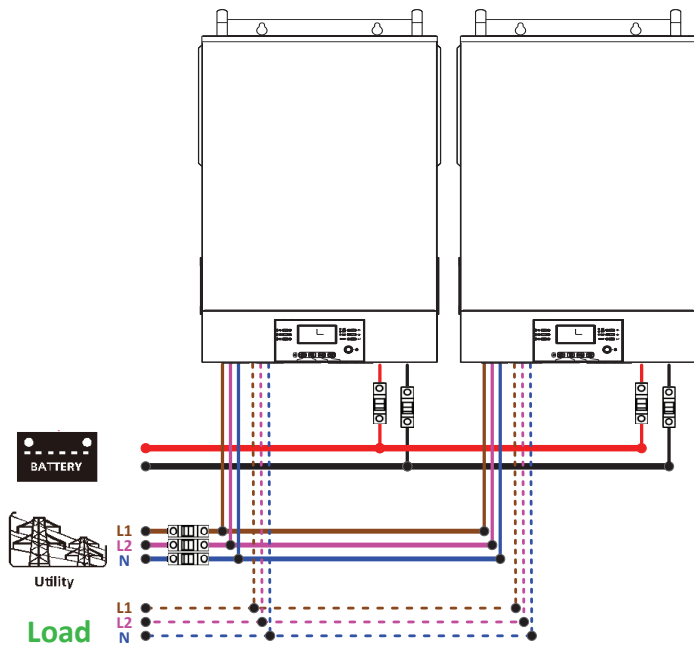

Communication Connection

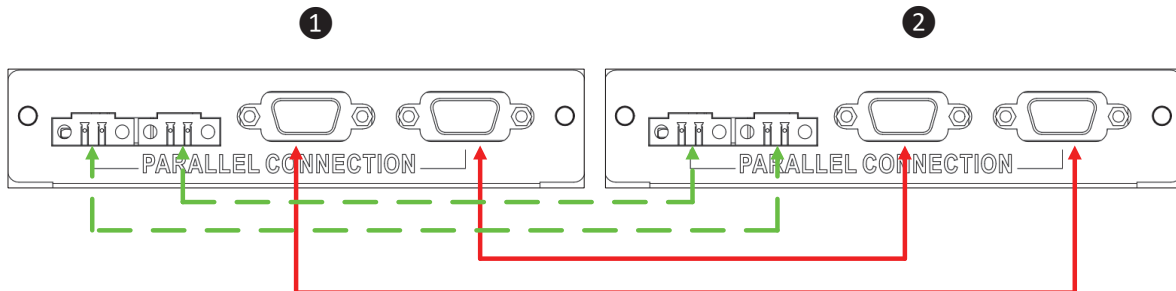

Three inverters in parallel:

Power Connection

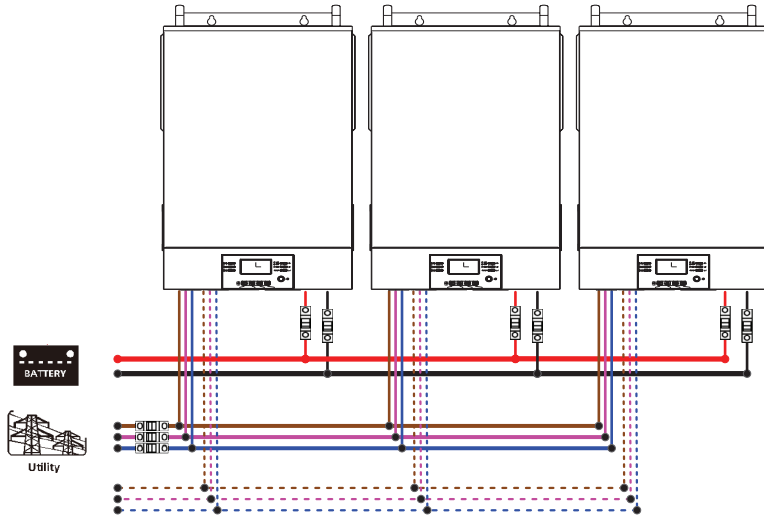

Communication Connection

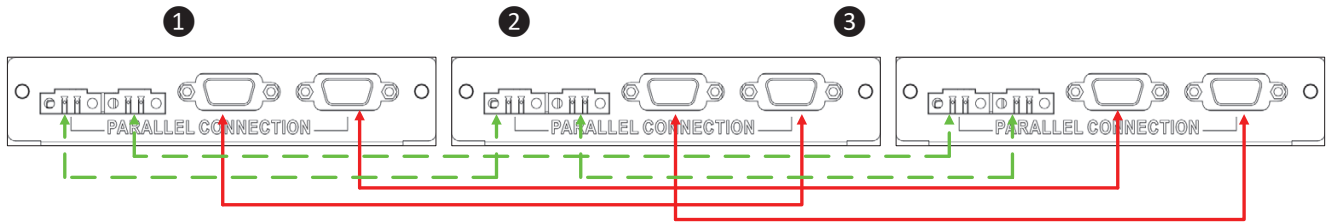

Four inverters in parallel:

Power Connection

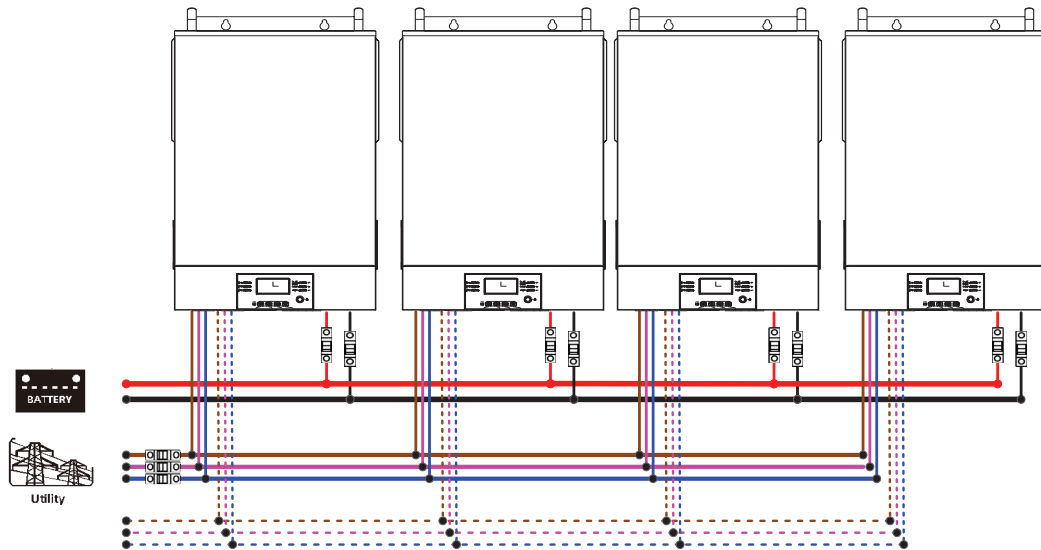

Communication Connection

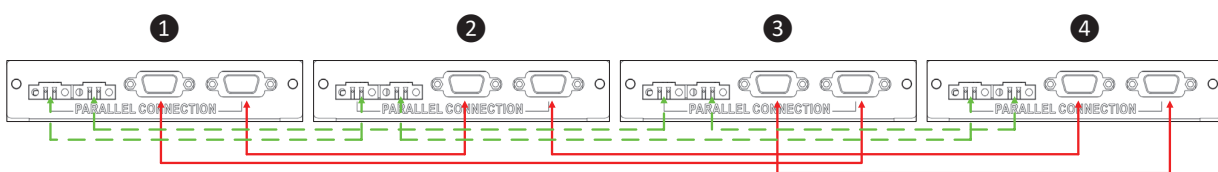

Five inverters in parallel:

Power Connection

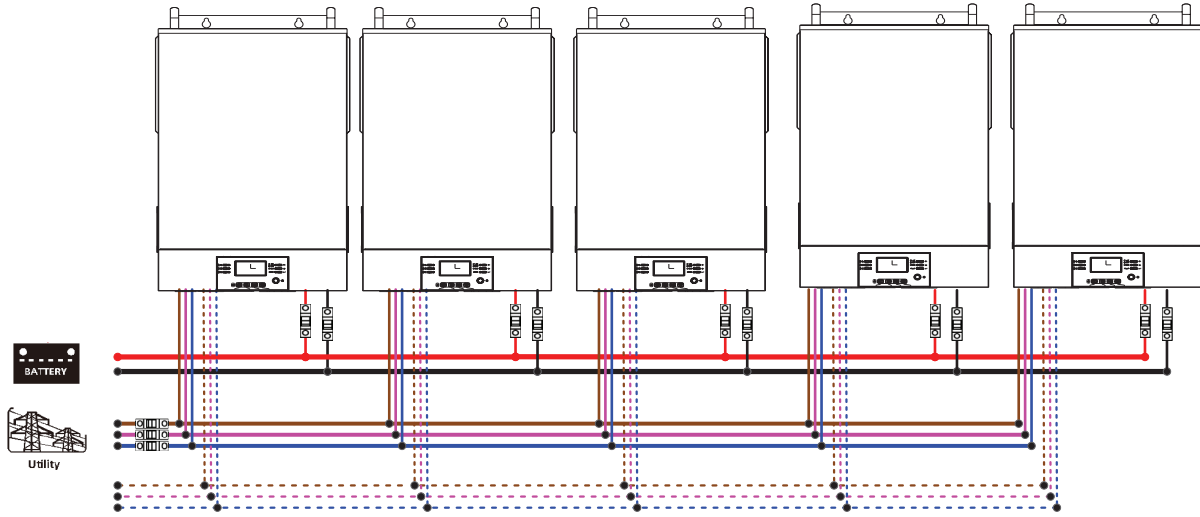

Communication Connection

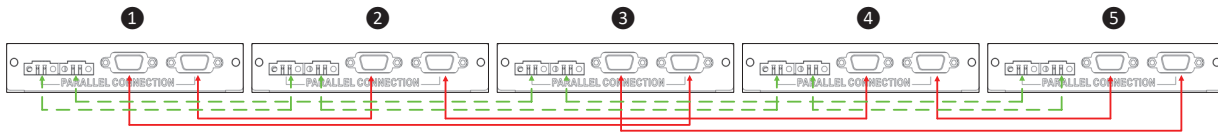

Six inverters in parallel:

Power Connection

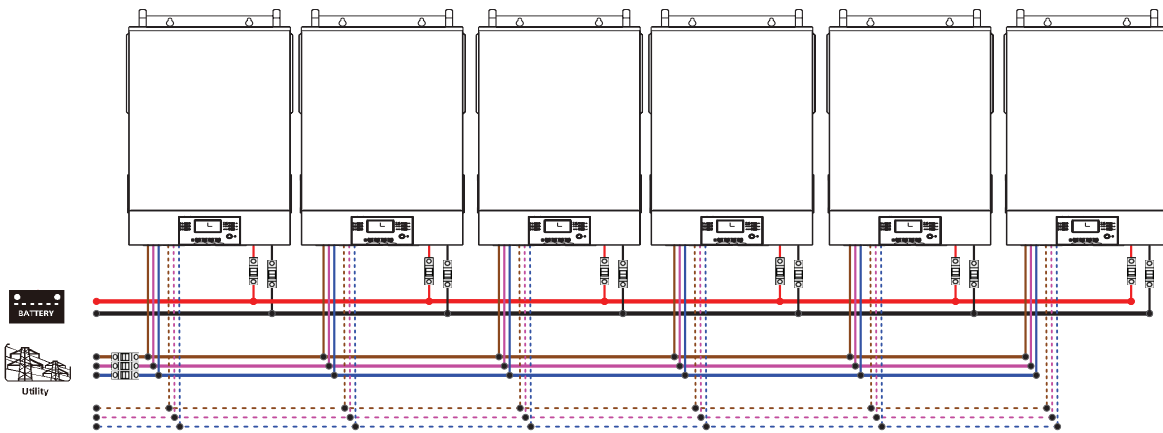

Communication Connection

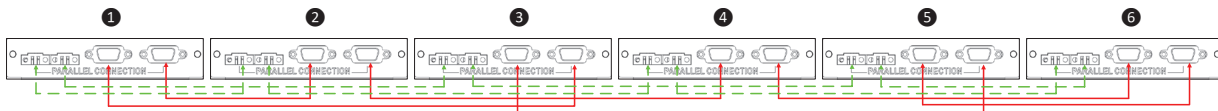

Seven inverters in parallel:

Power Connection

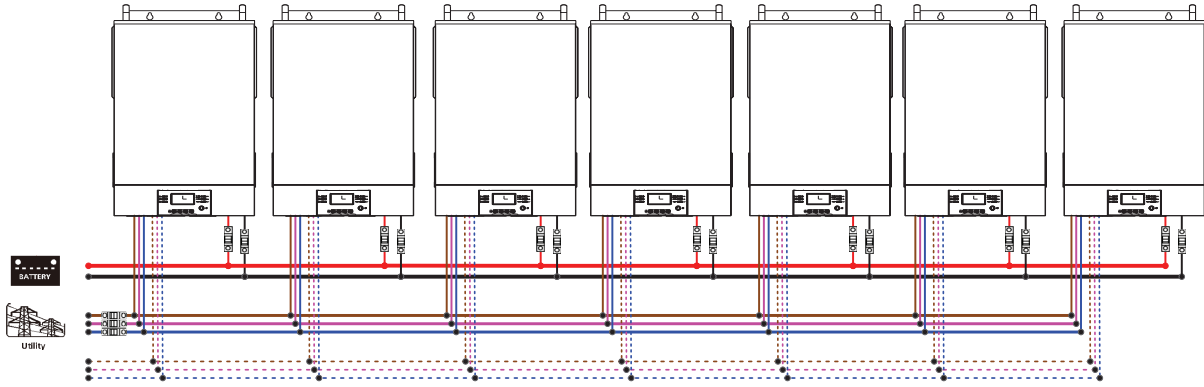

Communication Connection

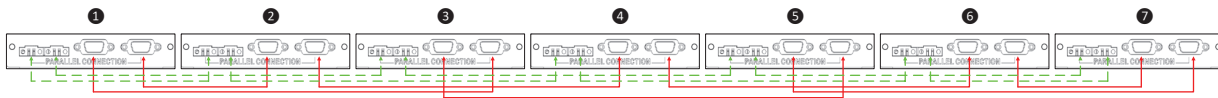

Eight inverters in parallel:

Power Connection

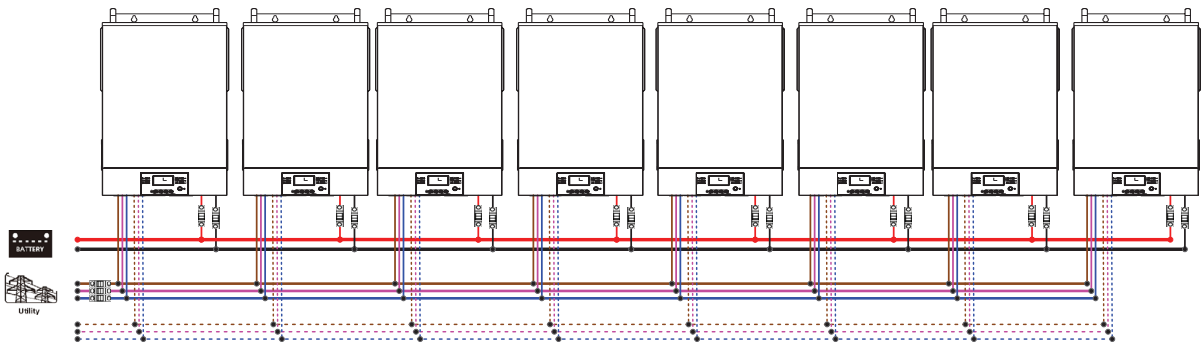

Communication Connection

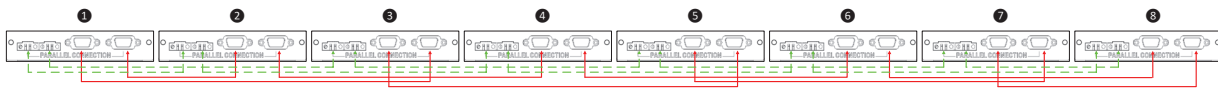

Nine inverters in parallel:

Power Connection

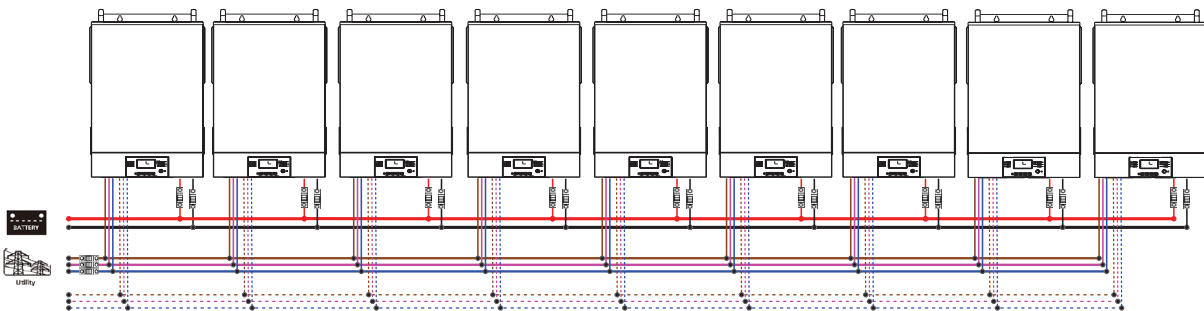

Communication Connection

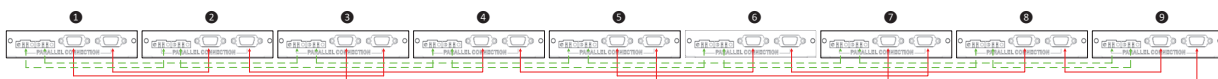





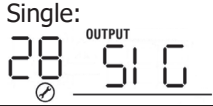
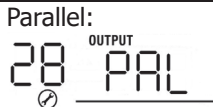



3. LCD Setting and Display

Setting Program:

Program	Description	Selectable option	
28	AC output mode *This setting is only available when the inverter is in standby mode (Switch off).	Single: 	When selected, the unit is used in single operation.
		Parallel: 	When selected, this inverter is operated in parallel system. The maximum number of parallel units is 9.

Parallel system fault codes:

Fault Code	Fault Event	Icon on
60	Power feedback protection	
71	Firmware version inconsistent	
72	Current sharing fault	
80	CAN fault	
81	Host loss	
82	Synchronization loss	
83	Battery voltage detected different	
84	AC input voltage and frequency detected different	
85	AC output current unbalance	

BMS Communication Install – EG4-LL

1. Introduction

When connecting to an EG4-LL battery use the supplied RJ45 battery communication cable. Please check with your dealer or installer for details.

This custom-made RJ45 communication cable delivers information and signal between lithium battery and the inverter. The information is listed below:

- Re-configure charging voltage, charging current and battery discharge cut-off voltage according to the lithium battery parameters as .
- Starting and stopping of charging is based on the batteries State Of Charge (SOC).

2. Pin Assignment for BMS Communication Port

PIN	Definition
PIN 1	RS232TX
PIN 2	RS232RX
PIN 3	RS485B
PIN 4	NC
PIN 5	RS485A
PIN 6	CANH
PIN 7	CANL
PIN 8	GND

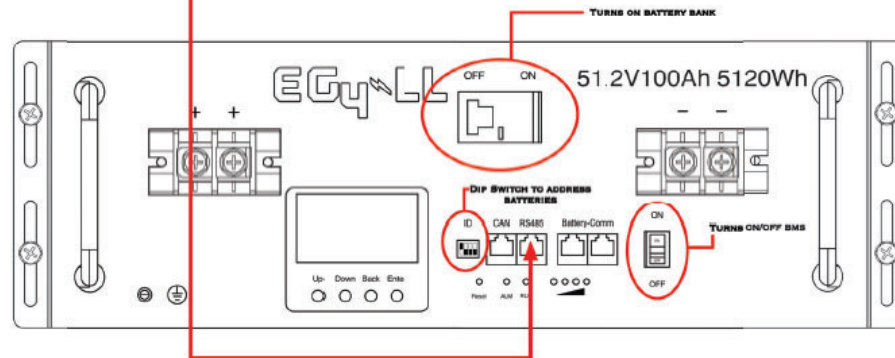
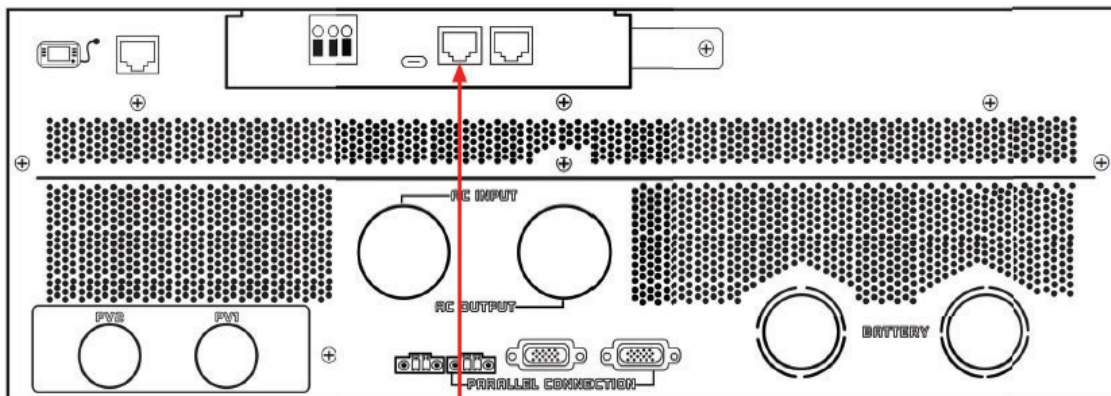
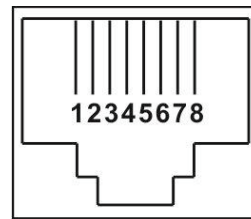

Battery Communication Install - EG4-LL Cont.

Using the 1ft RS485 cable, interconnect the batteries as illustrated in the diagram below.

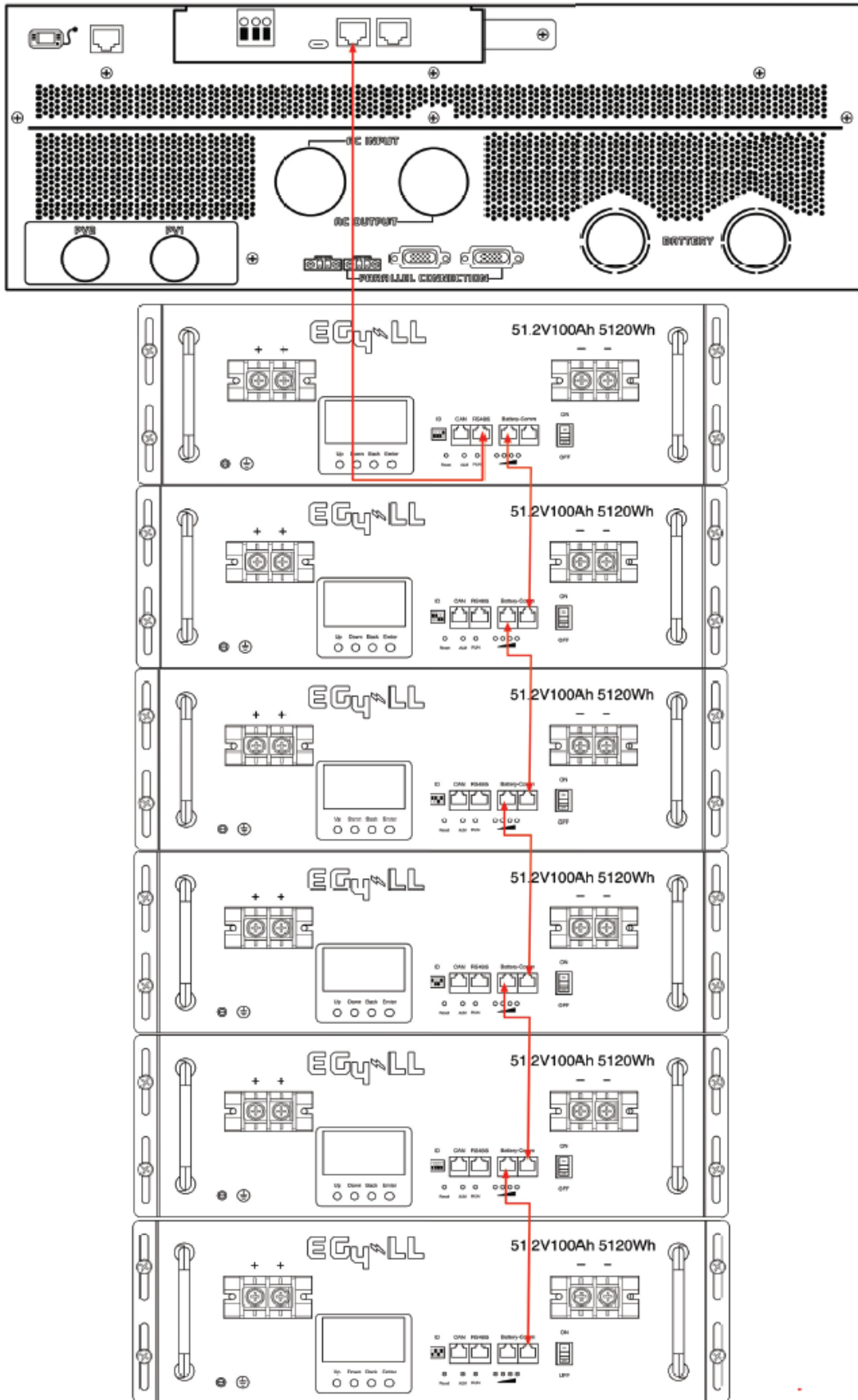

Battery Communication Install – LiFePower4

Using the 1ft RS485 cable, interconnect the batteries as illustrated in the diagram below.

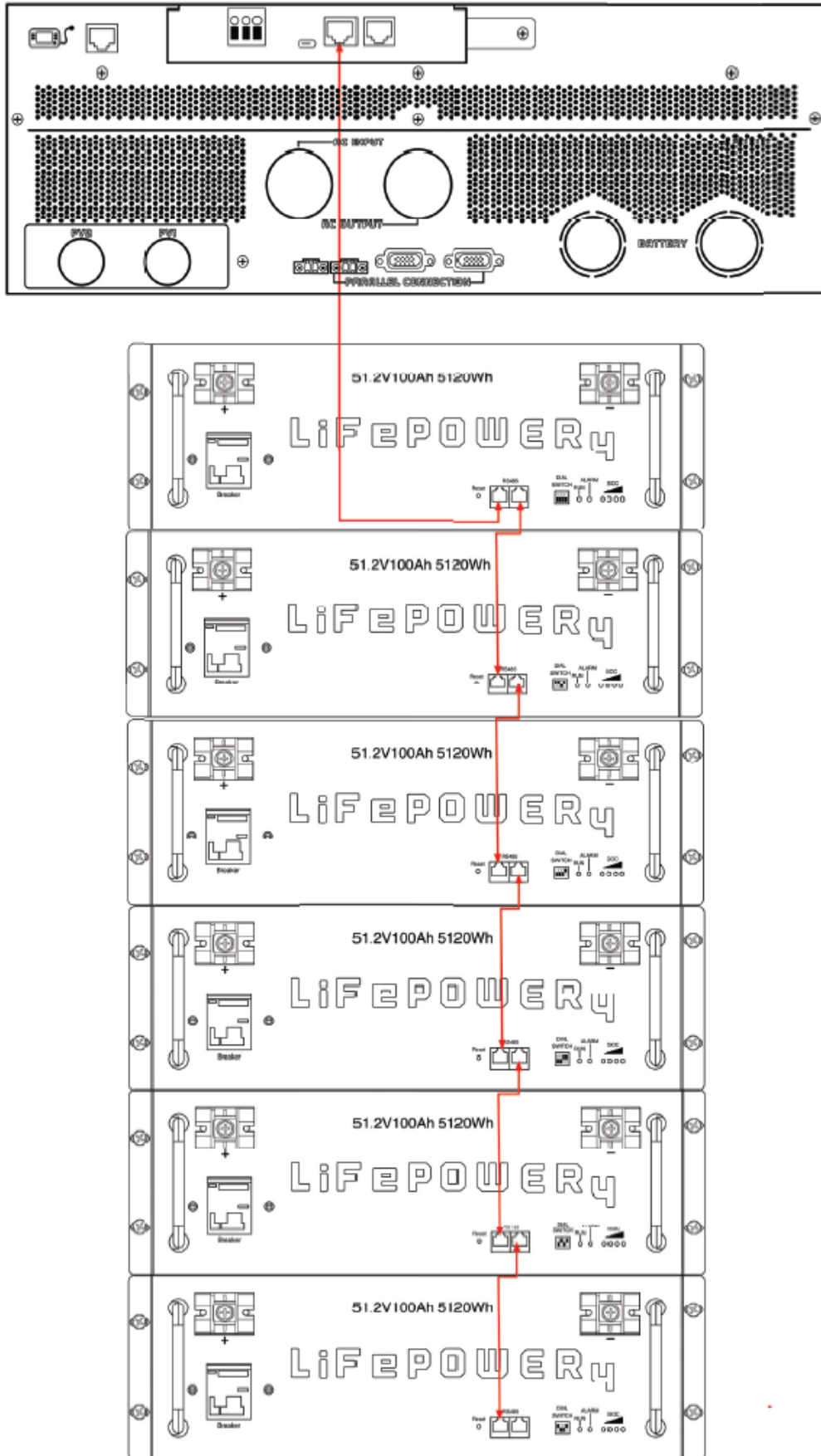

Settings for EG4 Lithium Batteries- Master/Slave

1). Dip Switch: There are 4 Dip Switches which set different baud rates and battery group addresses. If switch position is turned to the "OFF" position, it means "0". If switch position is turned to the "ON" position, it means "1".

EG4-LL Battery

- Dip 1, 2, and 3 are in the "ON" position *on = down
- Dip 4 is in the "OFF" position *off = up
- The 1-3 "ON" & 4 "OFF" configuration is to indicate Master battery status and is reserved for communications with the inverter.
- A Max of 16 batteries can communicate in a single battery bank using different dipswitch addresses.

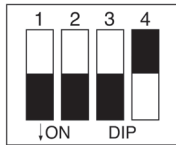

EG4-LifePower4 Battery

- Dip 1, 2, 3, and 4 are in the "OFF" position *off = down
- The ALL "OFF" position is to indicate the Master battery status and is reserved for communications with the inverter
- A Max of 16 batteries can communicate in a single battery bank.

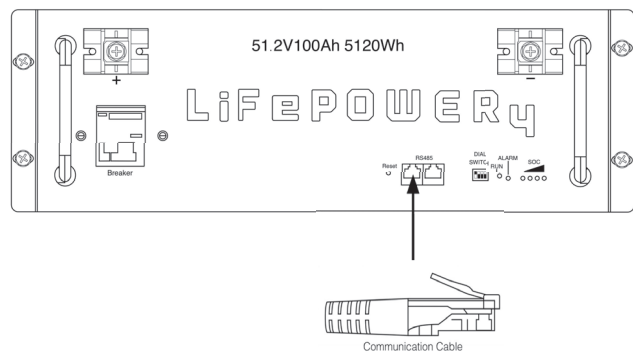
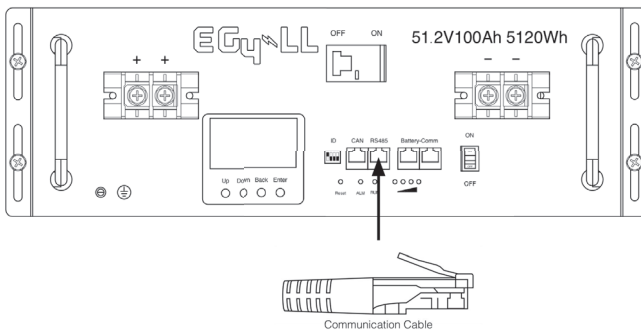
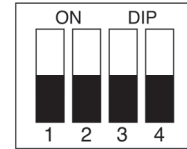

Please Note: If you change the dipswitches, you must power cycle the batteries for the BMS to recognize the new dipswitch address.

2). Installation

Step 1. Use the RS485 cable to connect the inverter and Lithium battery as Fig 1.

Step 2. Switch on the battery breaker/s.

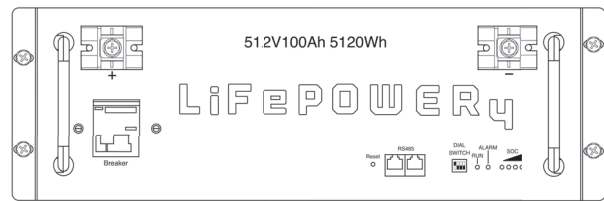
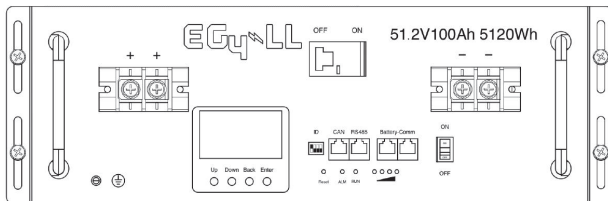

Step 3. Turn on the inverter.

Step 4. Select battery type as "EG4" in LCD program 5 for the Master inverter. For other paralleled inverters, you must set to "USE".

If communication between the inverter and battery is successful, the battery icon  on LCD display will flash

NOTE: For EG4-LL ensure the red power switch is set to "ON" as well as the breaker.

NOTE: Even with the EG4 batteries having built-in breakers, a minimum 150A in line breaker is required, and a 200A in line breaker is recommended.

NOTE: Refer to each battery manual for setting master and follower battery address settings.

Battery Based Commissioning **REQUIRED PROCEDURE**

Note: Systems must be commissioned while connected to a battery bank. PV or AC input only based commissioning is not recommended or supported.

NOTE: This guide is to be used after the physical installation of the system is complete.

NOTE: For best use case, ensure that all settings are programmed per user/site specific requirements.

Single Unit Systems:

Step 1 - Ensure all inverter connections are correct, and all input and output breakers of the system are off.

Step 2 - Turn on the system's DC breaker (between inverter and batteries if equipped), master battery breaker and/or power button, and then power on the inverter by depressing the power button (in that exact order).

Step 3 - After the startup countdown, hold the enter "↵" button for 3 seconds to access the settings menu.

Step 4 - Use the down arrow to go to program setting 28 (AC output mode). **Note:** If the inverter is already set to "SIG", press escape to return to main screen, power on the rest of the batteries and skip to Step 10.

Step 5 - Depress/release the power button to go into standby mode.

Step 6 - Press the enter button, then use the up and down buttons to set the inverter to "SIG." Press the enter button (to save the setting) and then press escape to return to the main screen.

Step 7 - Depress the power button to exit standby mode.

Step 8 - Turn off battery breakers and inverter to power down the system to ensure settings implementation.

Step 9 - Turn on the system's DC breaker (between inverter and batteries if equipped), all battery breakers and/or power buttons.

Step 10 - Switch on all AC in breakers.

Step 11 - Ensure PV voltage meets specifications on page 9. Turn on PV power.

Step 12 - Depress the power button on the inverter to power on the unit.

Step 12 - Switch on all AC out breakers.

Battery Based Commissioning **REQUIRED PROCEDURE Cont.**

Multi-unit Systems:

Step 1 - Ensure all inverter connections are correct, and all input and output breakers of the system are off.

Step 2 - Turn on the system's DC breaker (between inverters and batteries if equipped), master battery breaker and/or power button, and then power on all inverters by depressing the power buttons (in that exact order).

Step 3 - After the startup countdown, hold the enter "↵" button for 3 seconds to access the settings menu.

Step 4 - Use the down arrow to go to program setting 28 (AC output mode).

Step 5 - Depress/release the power button to go into standby mode.

Step 6 - Press the enter button, then use the up and down buttons to set the inverter to "PAL." Press the enter button (to save the setting) and then press escape to return to the main screen.

Step 7 - Depress the power button to exit standby mode. Repeat steps 3-7 for all inverters.

Step 8 - Turn off battery breakers and inverters to power down the system and ensure settings implementation.

Step 9 - Turn on the system's DC breaker (between inverters and batteries if equipped), all battery breakers and/or power buttons.

NOTE: Host and slave inverters will be randomly defined.

Step 10 - Switch on all AC in breakers.

Step 11 - Ensure PV voltage meets specifications on page 9. Turn on PV power.

Step 12 - Depress the power button on the inverter to power on the unit, starting with the host.



















Step 12 - Switch on all AC out breakers.

Troubleshooting

Warning Indicator

Warning Code	Warning Event	Icon flashing
01	Fan locked	[01]△
02	Over temperature	[02]△
03	Battery over charged	[03]△
04	Low battery	[04]△
07	Overload	[07]△ 
10	Inverter power derating	[10]△
15	PV is weak	[15]△
19	Battery is not connected	[bP]△
32	DSP remote command loss	[32]△
60	BMS disable charge/discharge	[60]△
61	BMS command loss	[61]△
62	BMS pack warning	[62]△
69	BMS stopped charge	[69]△
70	BMS force charge	[70]△
71	BMS stopped discharge	[71]△

Faults Reference Code

Fault Code	Fault Event	Icon on
01	Fan is locked.	
02	Over temperature	
03	Battery voltage is too high.	
04	Battery voltage is too low.	
05	Output is short circuited.	
06	Output voltage is abnormal.	
07	Overload time out.	
08	Bus voltage is too high.	
09	Bus soft start failure.	
10	PV current is over.	
11	PV voltage is over.	
12	Charge current is over.	
51	Over current or surge	
52	Bus voltage is too low.	
53	Inverter soft start failure.	
55	Over DC offset in AC output	
56	Battery is not connected.	
57	Current sensor failure.	
58	Output voltage is too low.	

General Trouble Shooting

Problem	LCD/LED/Buzzer	Explanation / Possible cause	What to do
Unit shuts down automatically during startup process.	LCD/LEDs and buzzer will be active for 3 seconds and then complete off.	The battery voltage is too low (<1.91V/Cell)	1. Re-charge battery. 2. Replace battery.
No response after power on.	No indication.	1. The battery voltage is far too low. (<1.4V/Cell) 2. Battery polarity is connected reversed.	1. Check if batteries and the wiring are connected well. 2. Re-charge battery. 3. Replace battery.
Utility/AC input is available, but the unit only pulls energy from the batteries when in utility/AC input as priority source.	Input voltage is displayed as 0 on the LCD and green LED is flashing.	Input protector is tripped	Check if AC breaker is tripped and AC wiring is connected well.
	Green LED is flashing.	Insufficient quality of AC power. (Utility or Generator)	1. Check if AC wires are too thin and/or too long. 2. Check if generator (if applied) is working well or if input voltage range setting is correct. (UPS→Appliance)
	Green LED is flashing.	You have set "Solar First" as the priority of output source.	Change output source priority to Utility first.
When the unit is turned on, internal relay is switched on and off repeatedly.	LCD display and LEDs are flashing	Battery is disconnected.	Check if battery wires are connected well.
Buzzer beeps continuously and red LED is on.	Fault code 07	Overload error. The inverter is overload 110% and time is up.	Reduce the connected load by switching off some equipment.
	Fault code 05	Output short circuited.	Check if wiring is connected well and remove abnormal load.
		Temperature of internal converter component is over 248°F (120°C).	Check whether the air flow of the unit is blocked or whether the ambient temperature is too high.
	Fault code 02	Internal temperature of inverter component is over 212°F (100°C).	
	Fault code 03	Battery is over-charged.	Return to repair center.
		The battery voltage is too high.	Check if spec and quantity of batteries meet requirements.
	Fault code 01	Fan fault	Replace the fan.
	Fault code 06/58	Output abnormal (Inverter voltage below than 190Vac or is higher than 260Vac)	1. Reduce the connected load. 2. Return to repair center
	Fault code 08/09/53/57	Internal components failed.	Return to repair center.
	Fault code 10	Surge	Restart the unit, if the error happens again, please return to repair center.
	Fault code 12	DC/DC over current or surge.	
	Fault code 51	Over current or surge.	
	Fault code 52	Bus voltage is too low.	
Fault code 55	Output voltage is unbalanced.		
Fault code 56	Battery is not connected well or fuse is burnt.	If the battery is connected well, please return to repair center.	
Fault code 11	Solar input voltage is more than 500V.	Reduce solar input below 500V in all temperatures	

Parallel Systems Trouble Shooting

Situation		Solution
Fault Code	Fault Event Description	
60	Current feedback into the inverter is detected.	<ol style="list-style-type: none"> 1. Restart the inverter. 2. Check if L1/L2/N cables are phased properly in all inverters. 3. For parallel system in split phase, make sure the red/black current sharing cables are connected well (with screws) to all inverters. 4. If the problem remains, please contact your installer.
71	The firmware version of each inverter is not the same.	<ol style="list-style-type: none"> 1. Update all inverter firmware to the same version. 2. Check the version of each inverter via LCD settings and make sure the CPU versions are the same. If not, please contact your installer/retailer to provide the firmware to update. 3. After updating, if the problem still remains, please contact your installer.
72	The output current of each inverter is different.	<ol style="list-style-type: none"> 1. Check if sharing cables are connected properly and restart the inverter. 2. If the problem remains, please contact your installer.
80	CAN data loss	<ol style="list-style-type: none"> 1. Check if communication cables are connected well and restart the inverter. 2. If the problem remains, please contact your retailer installer.
81	Host data loss	
82	Synchronization data loss	
83	The battery voltage of each inverter is not the same.	<ol style="list-style-type: none"> 1. Make sure all inverters share the same battery bank 2. Remove all loads and disconnect AC input and PV input. Then, check battery voltage of all inverters. If the values from all inverters are close, please check if all battery cables are the same length and same material type. Otherwise, please contact your installer/retailer to provide SOP to calibrate battery voltage of each inverter. 3. If the problem still remains, please contact your retailer or installer.
84	AC input voltage and frequency are different.	<ol style="list-style-type: none"> 1. Check the utility wiring connection and restart the inverter. 2. Make sure utility starts up at same time. If there are breakers installed between utility and inverters, please be sure all AC input breakers can be powered on at one time. A main breaker or disconnect is required 3. If the problem remains, please contact your installer.
85	AC output current unbalance	<ol style="list-style-type: none"> 1. Restart the inverter. 2. Remove some excessive loads and re-check load information from LCD of inverters. If the values are different, please check if AC input and output cables are in the same length and material type. 3. If the problem remains, please contact your installer.

Wi-Fi Operation Guide in Remote Panel

1. Introduction

The Wi-Fi module can enable wireless communication between off-grid inverters and the cloud monitoring platform. Users have complete and remote monitoring and control experience for inverters when combining the Wi-Fi module with the SolarPower APP, available for both iOS and Android based device. All data loggers and parameters are saved in the the cloud.

The major functions of this APP:

- Delivers device status during normal operation.
- Allows to configure device settings after installation.
- Notifies users when a warning or alarm occurs.
- Allows users to query inverter history data.



2. SolarPower App

2.1. Download and install the APP

Operating system requirement for your smart phone:

🍏 iOS system supports iOS 9.0 and above

🤖 Android system supports Android 5.0 and above

Please scan the following QR code with your smart phone and download SolarPower App.



Android
system





iOS system

Or you may find "SolarPower" app from the Apple® Store or "SolarPower Wi-Fi" in Google® Play Store.



Initial Setup

Step 1: Registration at first time

After the installation, please tap the shortcut icon  to access this APP on your mobile screen. In the screen, tap "Register" to access "User Registration" page. Fill in all required information and scan the remote box PN by tapping  icon. Or you can simply enter PN directly. Then, tap "Register" button.

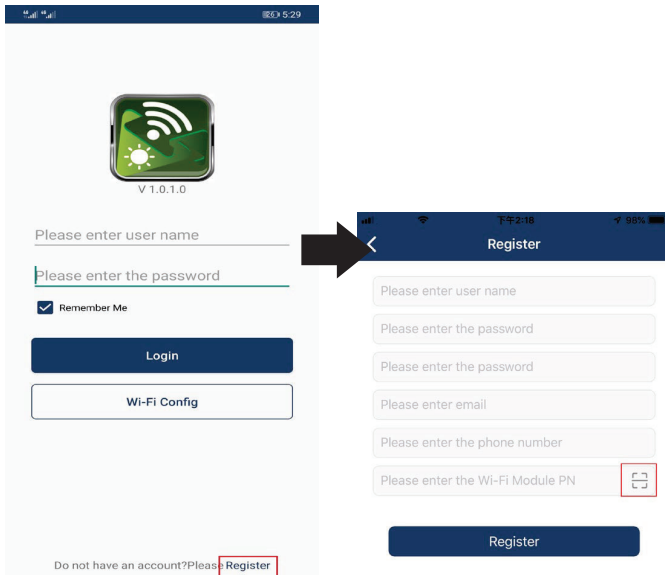

Then, a “Registration success” window will pop up. Tap “Go now” to continue setting local Wi-Fi network connection.

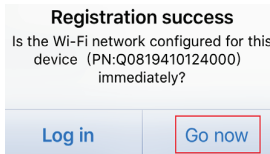

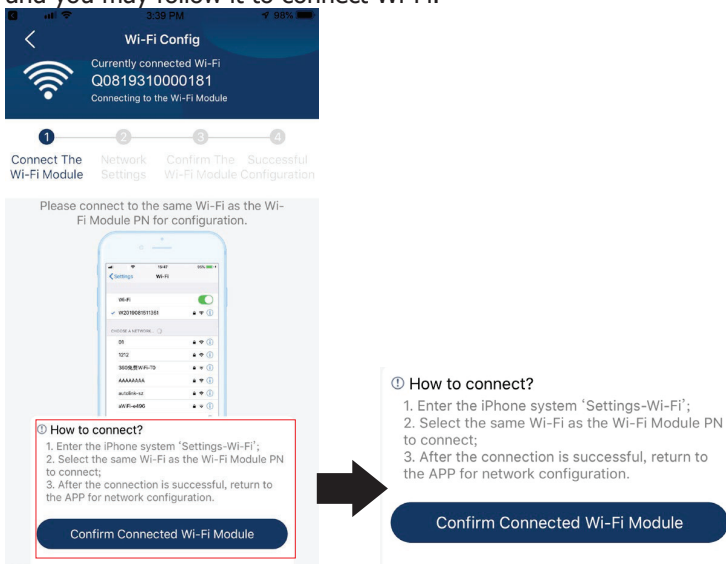

Step 2: Local Wi-Fi Module Configuration

Now, you are in “Wi-Fi Config” page. There are detailed setup procedure listed in “How to connect?” section and you may follow it to connect Wi-Fi.

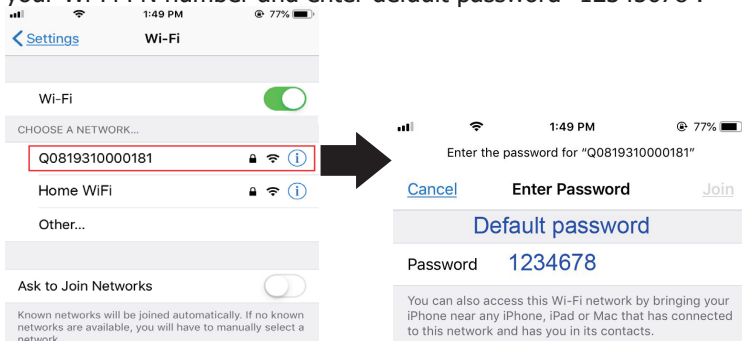

Enter the “Settings→Wi-Fi” and select connected Wi-Fi name. The connected Wi-Fi name is the same as your Wi-Fi PN number and enter default password “12345678”.



Then, return to SolarPower APP and tap “  ” button when Wi-Fi module is connected successfully.

Step 3: Wi-Fi Network settings

Tap  icon to select your local Wi-Fi router name (to access the internet) and enter password.

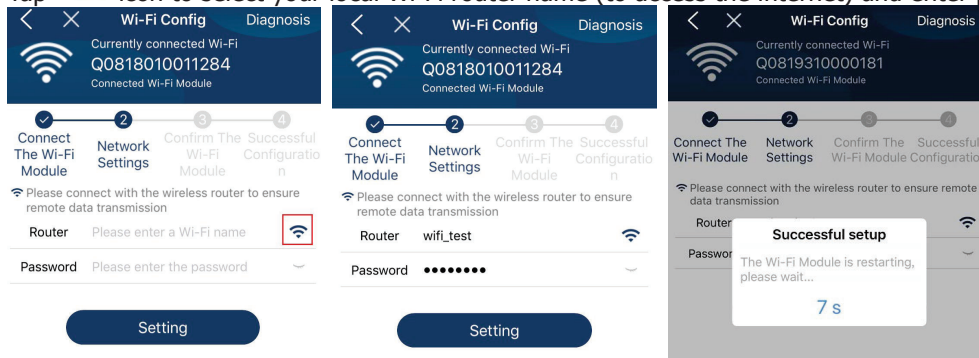

Step 4: Tap “Confirm” to complete the Wi-Fi configuration between the Wi-Fi module and the Internet.

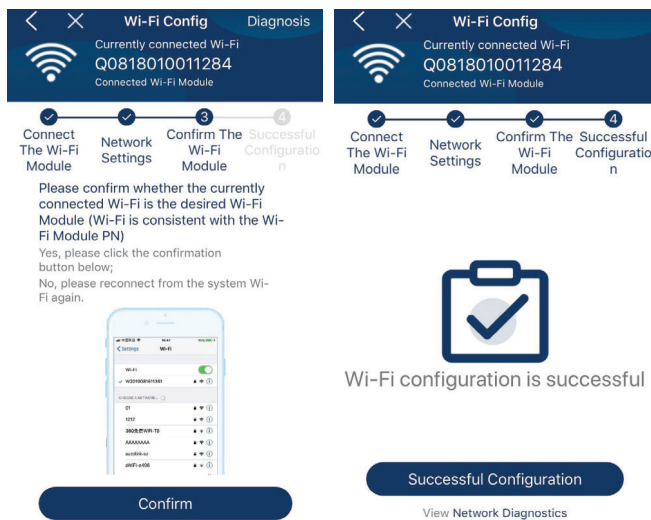

If the connection fails, please repeat Step 2 and 3.

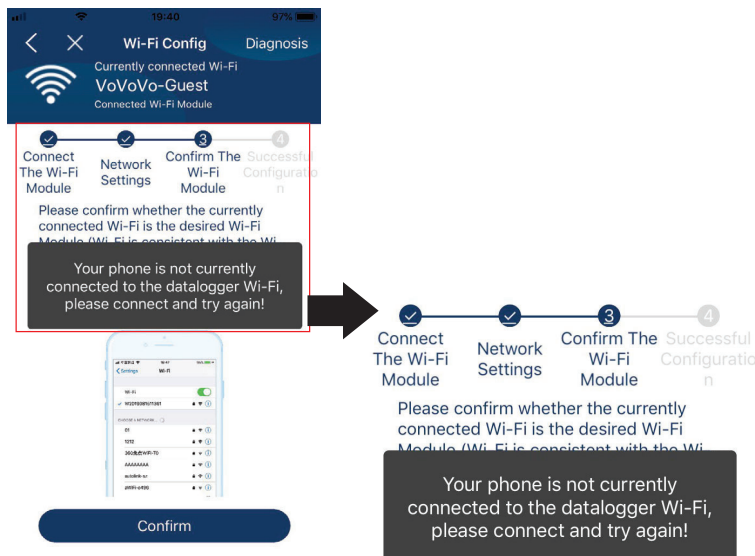

Diagnose Function

If the module is not monitoring properly, please tap "Diagnosis" on the top right corner of the screen for further details. It will show repair suggestions. Please follow it to fix the problem. Then, repeat the steps in the chapter 4.2 to re-set network setting. After all setting, tap "Rediagnosis" to re-connect again.



Repair suggestion **Rediagnosis**

The Inverter and the datalogger communicate abnormally.

- Please check if the Inverter and the datalogger are powered on normally.
- Please check if the Inverter address is between 1 and 5.
- Please check if the connection between the Inverter and the collector is abnormal, such as poor contact caused by oxidation or looseness of the interface, reverse connection of the 485 interface AB line, and data line damage.
- Try restarting the Inverter and datalogger to see if the anomaly is eliminated.

Datalogger and router communication abnormalities

- Please confirm that the wireless routing network setting has been made.
- Make sure that the datalogger is set up to connect to AP hotspots sent by hardware devices such as wireless routers instead of virtual AP hotspots.

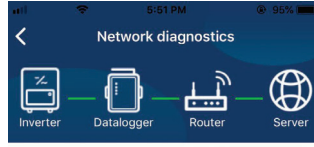

Repair suggestion **Rediagnosis**

The diagnosis is successful!

Login and APP Main Function

After finishing the registration and local Wi-Fi configuration, enter registered name and password to login.

Note: Select "Remember Me" for your login convenience afterwards.

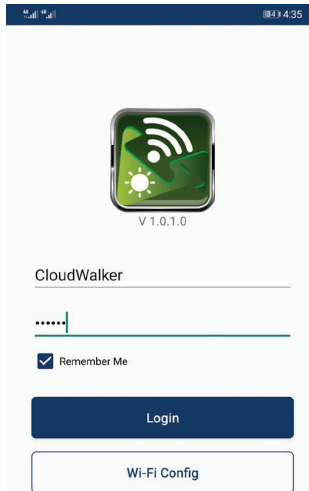

V 1.0.1.0

CloudWalker

.....

Remember Me

Login

Wi-Fi Config

Overview

After login is successful, you can access the "Overview" page to have an overview of your monitoring devices, including overall operation situation and energy information for current power and daily power as below diagram.

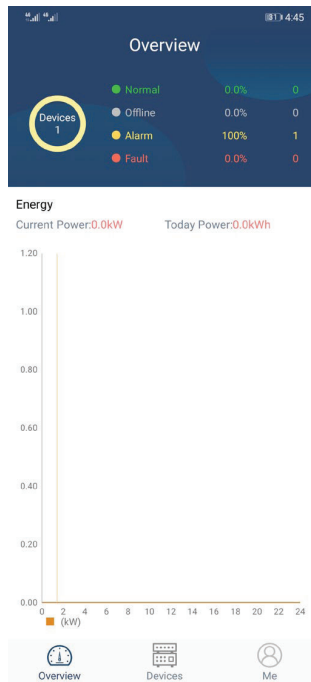

Devices

Tap the  icon (located on the bottom) to enter Device List page. You can review all devices here by adding or deleting Wi-Fi Module in this page.

Add device

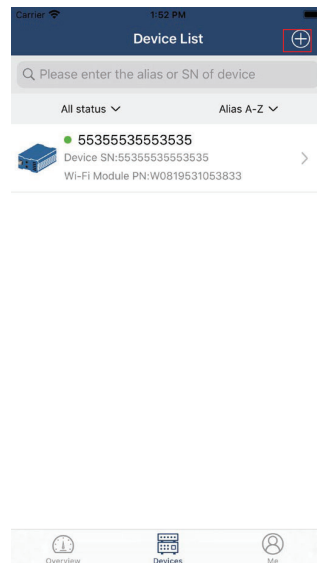

Delete device

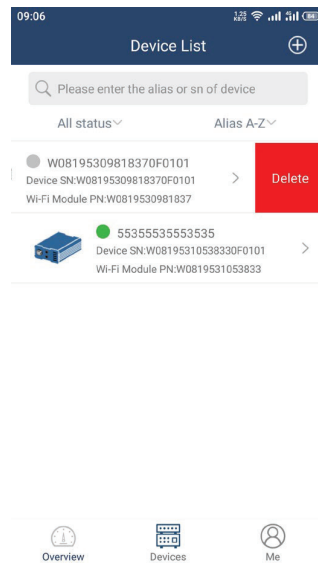

Tap  icon on the top right corner and manually enter part number to add device. This part number label is pasted on the bottom of remote LCD panel. After entering part number, tap "Confirm" to add this device in the Device list.

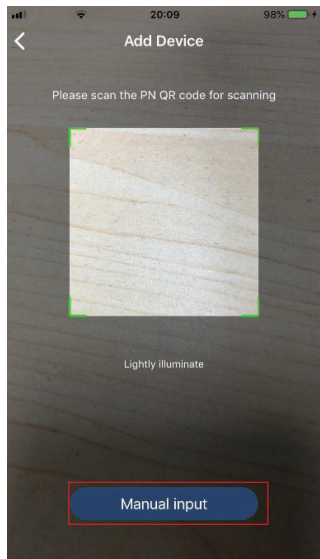

Part number label is pasted on the bottom of remote LCD panel.

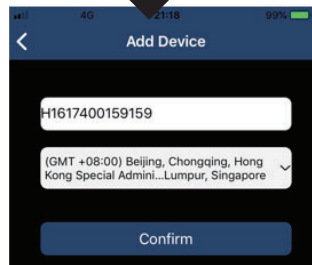
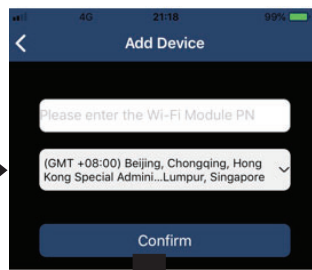

For more information about Device List, please refer to the section 2.4.

User Information

In ME page, users can modify "My information", including 【User's Photo】 , 【Account security】 , 【Modify password】 , 【Clear cache】 , and 【Log-out】 , shown as below diagrams.

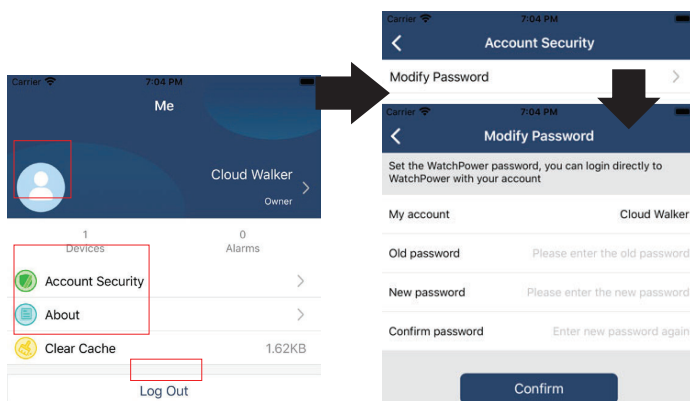

2.2. Device List

In Device List page, you can pull down to refresh the device information and then tap any device you want to check up for its real-time status and related information as well as to change parameter settings. Please refer to the parameter setting list.

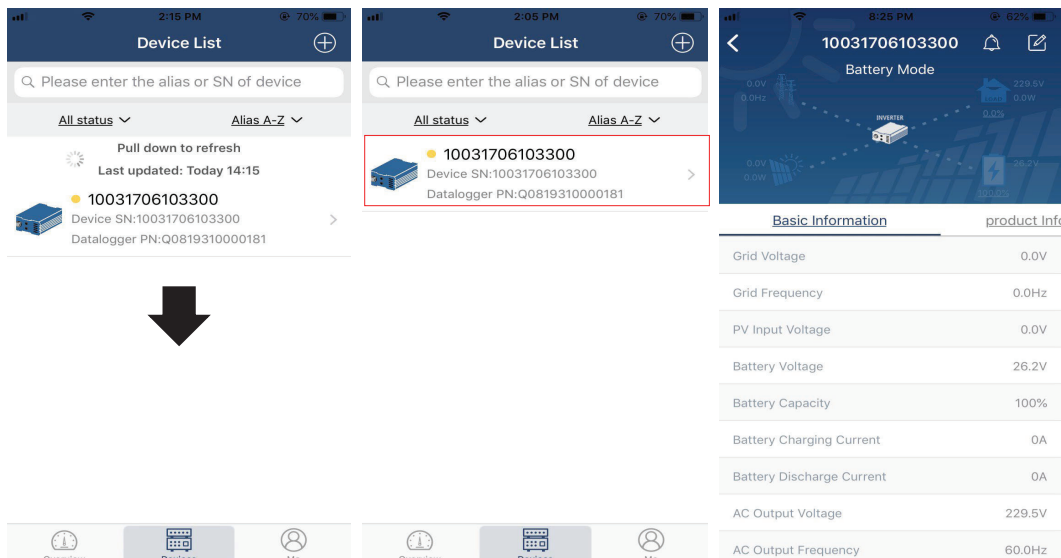

Device Mode

On the top of screen, there is a dynamic power flow chart to show live operation. It contains five icons to present PV power, inverter, load, utility and battery. Based on your inverter model status, there will be **【Standby Mode】** , **【Line Mode】** , **【Battery Mode】** .

【Standby Mode】 Inverter will not power the load until “ON” switch is pressed. Qualified utility or PV source can charge battery in standby mode.

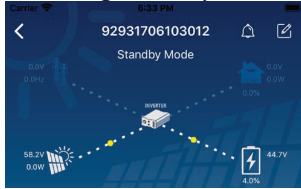



【Line Mode】 Inverter will power the load from the utility with or without PV charging. Qualified utility or PV source can charge battery.

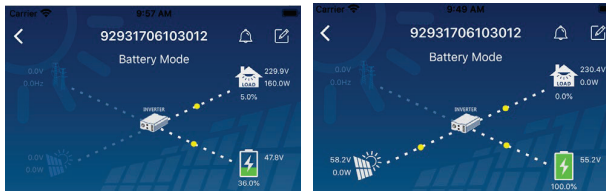

【Battery Mode】 Inverter will power the load from the battery with or without PV charging. Only PV source can charge battery.



Device Alarm and Name Modification

In this page, tap the  icon on the top right corner to enter the device alarm page. Then, you can review alarm history and detailed information. Tap the  icon on the top right corner, a blank input box will pop out. Then, you can edit the name for your device and tap “Confirm” to complete name modification.

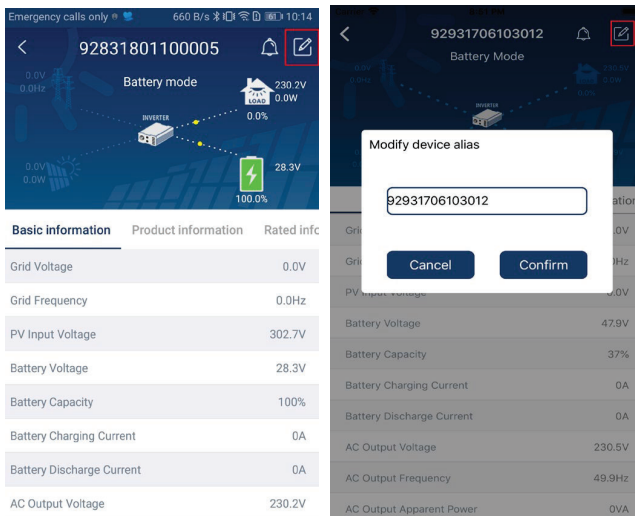

Device Information Data

Users can check up **【Basic Information】** , **【Product Information】** , **【Rated information】** , **【History】** , and **【Wi-Fi Module Information】** by swiping left.

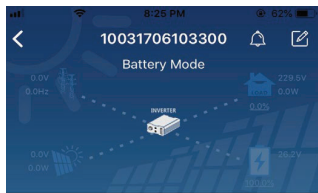

Basic Information	product Info
Grid Voltage	0.0V
Grid Frequency	0.0Hz
PV Input Voltage	0.0V
Battery Voltage	26.2V
Battery Capacity	100%
Battery Charging Current	0A
Battery Discharge Current	0A
AC Output Voltage	229.5V
AC Output Frequency	60.0Hz

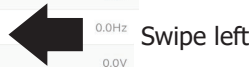

【Basic Information】 displays basic information of the inverter, including AC voltage, AC frequency, PV input voltage, Battery voltage, Battery capacity, Charging current, Output voltage, Output frequency, Output apparent power, Output active power and Load percent. Please slide up to see more basic information.

【Production Information】 displays Model type (Inverter type), Main CPU version and secondary CPU version.

【Rated Information】 displays information of Nominal AC voltage, Nominal AC current, Rated battery voltage, Nominal output voltage, Nominal output frequency, Nominal output current, Nominal output apparent power and Nominal output active power. Please slide up to see more rated information.

【History】 displays the record of unit information and setting timely.

【Wi-Fi Module Information】 displays of Wi-Fi Module PN, status and firmware version.

Parameter Setting

This page is to activate some features and set up parameters for inverters. Please note that the listing in "Parameter Setting" page in the below diagram may differ from the models of each inverter. To highlight a few: **【Output Setting】** , **【Battery Parameter Setting】** , **【Enable/ Disable items】** , **【Restore to the defaults】**

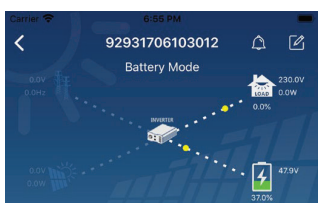

Parameter Setting	Wi-Fi Mod
Output Setting	>
Battery Parameter Setting	>
Enable/Disable items	>
Restore to the defaults	>
Time zone setting	>
Wi-Fi Module configuration	>

There are three ways to modify setting and they vary according to each parameter.

- Listing options to change values by tapping one of it.
 - Use the Activate/Shut down function by clicking the "Enable" or "Disable" button.
 - Changing values by clicking arrows or entering the numbers directly in the column.
- Each function setting is saved by clicking the "Set" button.

Please refer to below parameter setting list for an overall description and note that the available parameters may vary depending on different models. Please always see the original product manual for detailed setting instructions.

Parameter setting list:

Item		Description
Output setting	Output source priority	To configure load power source priority.
	AC input range	Input voltage range selection
	Output voltage	To set output voltage.
	Output frequency	To set output frequency.
Battery parameter setting	Battery Type	Select connected battery type
	Battery Cut-off Voltage	Set battery cut-off voltage
	Bulk Charging Voltage	Set battery bulk charging voltage
	Battery Float Voltage	Set battery floating charging voltage
	Max Charging Current	To configure total charging current for solar and utility chargers.
	Max AC Charging Current	Set maximum utility charging current
	Charging Source Priority	To configure charger source priority
	Back To Grid Voltage	Set battery voltage to stop discharging when grid is available
	Back To Discharge Voltage	Set battery voltage to stop charging when grid is available
Enable/Disable Functions	Overload Auto Restart	If disabled, the unit won't be restarted after overload occurs.
	Overload Temperature Auto Restart	If disabled, the unit won't be restarted after over-temperature fault is solved.
	Overload Bypass	If enabled, the unit will enter bypass mode when overload occurs.
	Beeps While Primary Source Interrupt	If enabled, buzzer will alarm when primary source is abnormal.
	Buzzer	If disabled, buzzer won't be on when alarm/fault occurred.
	Backlight	If disabled, LCD backlight will be off when panel button is not operated for 1 minute.
	LCD Screen Return To Default Display	If selected, no matter how users switch display screen, it will automatically return to default display screen (Input voltage /output voltage) after no button is pressed for 1 minute.
	Fault Code	If enabled, fault code will be recorded in the inverter when any fault

	Record	happens.
	Solar Supply Priority	Set solar power as priority to charge the battery or to power the load.
	Reset PV Energy Storage	If clicked, PV energy storage data will be reset.
	Start Time For Enable AC Charge Working	The setting range of start charging time for AC charger is from 00:00 to 23:00. The increment of each click is 1 hour.
	Ending Time For Enable AC Charge Working	The setting range of stop charging time for AC charger is from 00:00 to 23:00. The increment of each click is 1 hour.
	Scheduled Time For AC Output On	The setting range of scheduled time for AC output on is from 00:00 to 23:00. The increment of each click is 1 hour.
	Scheduled Time For AC Output Off	The setting range of scheduled time for AC output off is from 00:00 to 23:00. The increment of each click is 1 hour.
	Country Customized Regulations	Select inverter installed area to meet local regulation.
	Set Date Time	Set date time.
Restore to the default	This function is to restore all settings back to default settings.	