

EG4® 14.3kWh PowerPro WallMount All Weather Battery User Manual



Scan the QR code for
the most recent
version of this
manual!





Table of Contents

1. Abbreviations	2
2. Safety	3
2.1 Safety Instruction	3
2.2 Important Safety Notifications	3
3. Brief Introduction	5
3.1 Product Description	5
4. Packaging List	6
5. Battery Overview	7
5.1 Battery Diagram	8
6. Location Selection and Installation	9
6.1 Outdoor Conduit Box Installation* (sold separately)	10
6.2 Installation Without a Conduit Box	12
6.3 Installation With a Conduit Box	13
6.4 With EG4 18kPV Inverter	15
7. General Installation	18
7.1 Battery Paralleling Guide	18
7.2 Battery Cable Connections	19
7.3 Additional Configurations	20
8. Emergency Stop (RSD, ESS Disconnect)	23
9. Battery Communications	24
9.1 DIP Switch ID Table	24
9.2 LCD Screen	25
9.3 Communication Protocol Selection	26
10. Operation Guide	27
10.1 BMS Tools Installation and Interfacing	27
10.2 Interfacing with BMS Tools	30
11. Battery Charging	33
12. Troubleshooting, Maintenance & Disposal	33
12.1 Introduction to the BMS	33
12.2 BMS Protection	33
12.3 Troubleshooting	35
12.4 Battery End of Life	37
13. EG4® 10 Year Limited Warranty	37
13.1 Warranty Exclusions	37
14. Technical Specifications	38
14.1 Battery Performance Curves	38
14.2 Technical Specifications Table	39
15. Storage	41

1. Abbreviations

- AWG – American Wire Gauge
- A — Amp(s)
- Ah — Amp hour(s)
- AC — Alternating Current
- AHJ — Authority Having Jurisdiction
- ANSI — American National Standards Institute
- BMS — Battery Management System
- DC — Direct Current
- DIP — Dual In-line Package
- DOD – Depth of Discharge
- EG – Earth Ground
- ESS – Energy Storage System
- E-Stop NO — Emergency Stop Normally Open
- In. lbs. — Inch Pounds
- kW — Kilowatt
- kWh — Kilowatt-hour
- LFP — Lithium Iron Phosphate or LiFePO₄
- mm — Millimeter(s)
- mV — Millivolt(s)
- NEC — National Electrical Code
- NFPA — National Fire Prevention Association
- Nm — Newton meters
- PC — Personal Computer
- PCB – Printed Circuit Board
- PPE — Personal Protective Equipment
- PV — Photovoltaic
- RSD — Rapid Shut Down
- SOC — State of Charge
- V — Volt(s)

2. Safety

2.1 Safety Instruction

Before any work begins, carefully read all safety instructions, and always observe them when working on or with the battery. The installation must follow all applicable national or local standards and regulations. Consult with your AHJ to obtain the proper permits and permissions before installation.

Incorrect installation may cause:

- *injury or death to the installer, operator or third party*
- *damage to the battery or other attached equipment*

2.2 Important Safety Notifications

There are various safety concerns that must be carefully observed before, during, and after the installation, as well as during future operation and maintenance. The following are important safety notifications for the installer and any end users of this product under normal operating conditions.



Dangers of High Voltages and Large Current

1. **Do not disassemble the battery.** Contact your distributor for any issues in need of repair for proper handling instructions. Incorrect servicing or re-assembly may result in a risk of electric shock or fire and voiding the warranty.
2. **Never short-circuit DC inputs.** Short-circuiting your battery may result in a risk of electric shock or fire and can lead to severe injury or death and/or permanent damage to the unit and/or any connected equipment.
3. **Use caution when working with metal tools on or around batteries and systems.** Risk of electrical arcs and/or short circuiting of equipment can lead to severe injury or death and equipment damage.
4. **Beware of high battery current.** Please ensure that the battery module breakers and/or on/off switches are in the “open” or “off” position before installing or working on the battery. Use a voltmeter to confirm there is no voltage present to avoid electric shock.
5. **Do not make any connections or disconnections to the system while the batteries are operating.** Damage to system components or risk of electrical shock may occur if working with energized batteries.
6. An installer should make sure to be well protected by reasonable and professional insulative equipment [e.g., personal protective equipment (PPE)].
7. Before installing, operating, or maintaining the system, it is important to inspect all existing wiring to ensure it meets the appropriate specifications and conditions for use.
8. Ensure that the battery and system component connections are secure and proper to prevent damage or injuries caused by improper installation.

Warning

- 1. All work on this product must be carried out by qualified personnel. To reduce the risk of electric shock, do not perform any servicing other than that specified in the operating instructions unless you are qualified to do so.**
2. Read all instructions before commencing installation. For electrical work, follow all local and national wiring standards, regulations, and these installation instructions. All wiring should be in accordance with the National Electrical Code (NEC), ANSI/NFPA 70.
3. The battery and system can connect with the utility grid only if the utility provider permits. Consult with your utility and your local AHJ before installing this product for any additional permits, regulations and requirements for your area.
4. All warning labels and nameplates on this battery should be clearly visible and must not be removed or covered.
5. The installer should consider the safety of future users when choosing the battery's correct position and location as specified in this manual.
6. Please keep children away from touching or misusing the battery and relevant systems.
7. Be aware that the battery is very heavy. When moving the module, please use the team lift technique in order to prevent potential damage to the component and personnel.
8. Use the batteries only as directed. Do not attempt to open, disassemble, repair, tamper, or modify the batteries.
9. Do not insert any tools or any other foreign objects into the battery terminals
10. Avoid exposing batteries to conductive materials, such as water, strong oxidizers, and strong acids. Keep all flammable materials out of the working area.
11. Avoid putting batteries in direct sunlight or on extremely hot surfaces.
12. Use caution when handling batteries and/or battery-powered devices to avoid damaging the battery casing or connections. Do not pull, drag, throw, or mishandle the batteries while installing. Handle with care.
13. Before using batteries, inspect them for signs of damage. Never use damaged or puffy batteries. Please contact the distributor if a battery is received in this state or experience this issue.
14. Do not paint internal, external, or any part of the batteries
15. Install the WallMount in a location that prevents damage from flooding

DISCLAIMER

EG4® reserves the right to make changes to the material herein at any time without notice. You may refer to the EG4® website at www.eg4electronics.com for the most updated version of our manual.

3. Brief Introduction

Battery Features

- Constant rated output current of 200A for the outdoor WallMount
- IP65 all-weather rated, integrated self-heating during low ambient temperatures.
- Smart balancing of the cells enhancing the battery consistency and the lifespan up to 15 years of life with over 8000 cycles at 80% DOD at 0.5C
- Built-in intelligent BMS with battery voltage, current, temperature, and health management to reduce electrical risks and overheating
- Internal busbars rated to 600 Amps for paralleling multiple batteries and feeding multiple inverters
- Real time monitoring and LCD screen to display battery voltage, current, temperature, SOC in detail
- Integrated E-stop circuit, support emergency stop function with remote Rapid Shutdown Initiator (RSD) or Energy Storage Systems (ESS) disconnect or by inverter's RSD or ESS terminals
- Communicate with inverter using CAN or RS485. Firmware update using RS485
- Plug-and-play cable installation with the use of the 250A outdoor rated connectors
- Stable, reliable and maintenance-free battery pack
- Comprehensive safety UL9540A, UL1973 on cell and module level with enhanced onboard fire-extinguishing modules.

3.1 Product Description

The EG4® 48V PowerPro WallMount All Weather 280Ah batteries are ideal for low-voltage residential outdoor energy storage system (ESS) applications. These batteries use lithium iron phosphate (LiFePO₄ or LFP) cells with the highest safety performance and an intelligent Battery Management System (BMS) that can monitor and record the voltage of each cell, along with the current, voltage, and temperature of the module in real-time. The BMS also contains a passive balance function and an advanced battery control method, both of which improve the performance of the battery pack. For enhanced security, the battery has two onboard fire-extinguishing modules. With a design life of more than 15 years, the WallMount is designed to last over 8000 cycles at 80% DOD at 0.5C°.

4. Packing List

The items listed below are included with the purchase:



280Ah Battery
(Qty 1)

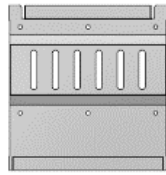

Mounting bracket
(Qty 1)



X-Bracket
(used for EG4-18kPV) (Qty 1)



Concrete
expansion bolts
M8×70 (Qty 6)



Black power cable 2/0 AWG
39.4 in (to inverter negative
terminal) (Qty 2)



Red power cable 2/0 AWG
39.4 in (to inverter positive
terminal) (Qty 2)



Battery to Inverter
communication cable
(Qty 1)

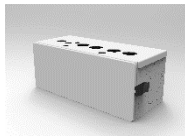

Conduit box (Qty 1)



Conduit box
plugs (Qty 9)



Rubber / plastic grommets
between battery and
conduit box (Qty 9)



Cable glands for conduit
box (Qty 16)

The following items are included in the optional conduit box kit

- Conduit box (Qty 1)
- Conduit box plugs (Qty 9)
- Rubber/plastic grommets between battery and conduit box (Qty 9)
- Cable glands for conduit box 1, 1.5 and 2.5in knockouts (Qty 16)



Red battery
parallel cable
53.1 in (Qty 1)



Black battery
parallel cable
53.1 in (Qty 1)



Parallel
communication
cable 59.1 in
(Qty 1)

The following items are included in the optional Battery Paralleling kit

- Red positive battery parallel cable 53.1 in. (Qty 1)
- Black negative battery parallel cable 53.1 in. (Qty 1)
- Parallel Communication cable 59.1 in. (Qty 1)

5. Battery Overview

Figure 1: Battery cross-sectional view

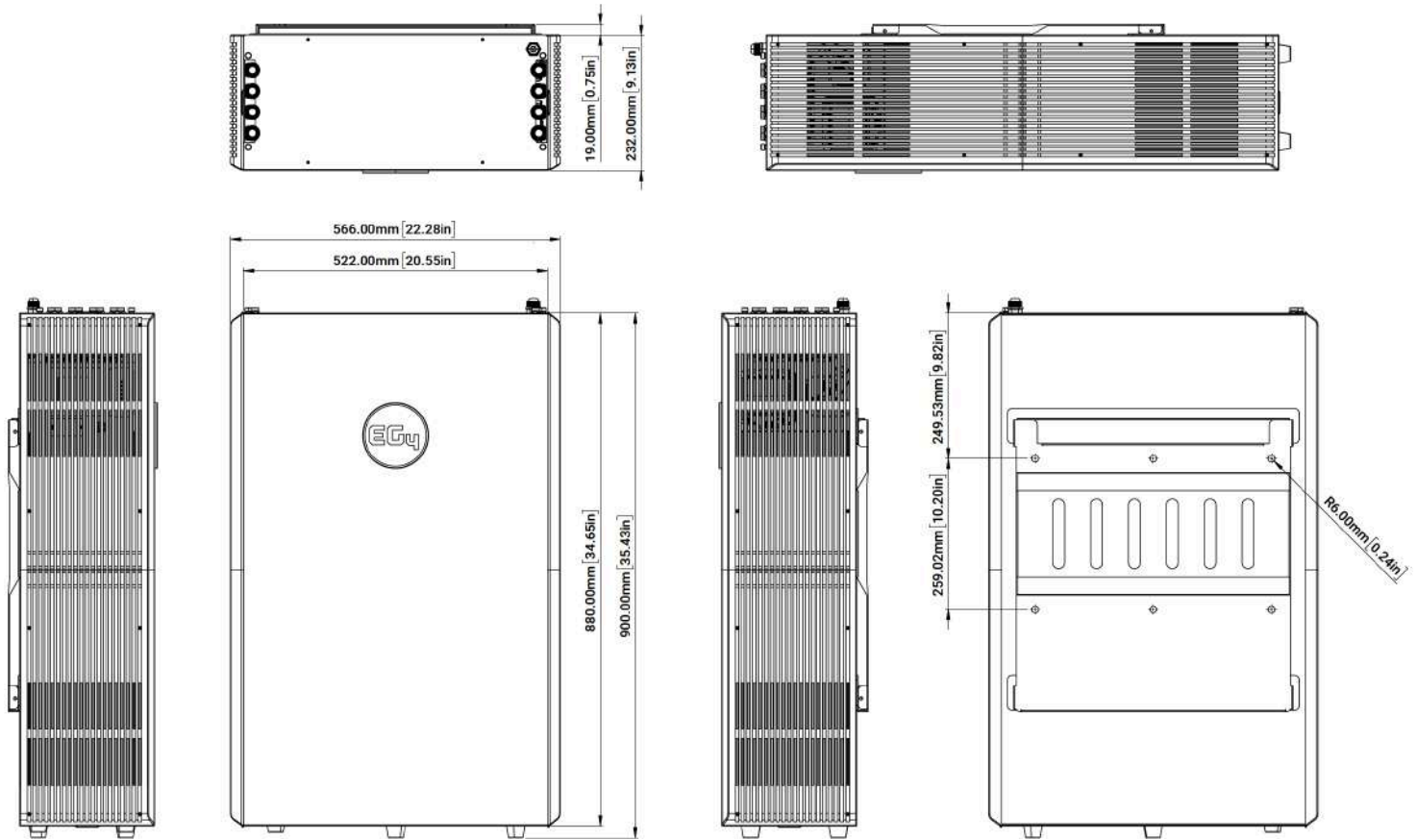

Danger!

When installing or removing battery, ensure battery is in the off position, and use a voltmeter to confirm there is no voltage present. This will prevent users from encountering live (powered) terminals by accident.

Failure to do so can result in severe injury and/or death.

5.1 Battery Diagram

It is highly recommended to install the battery with at least 12-inch clearance on each side of the battery (back and front sides excluded) in order to easily access the side panel.

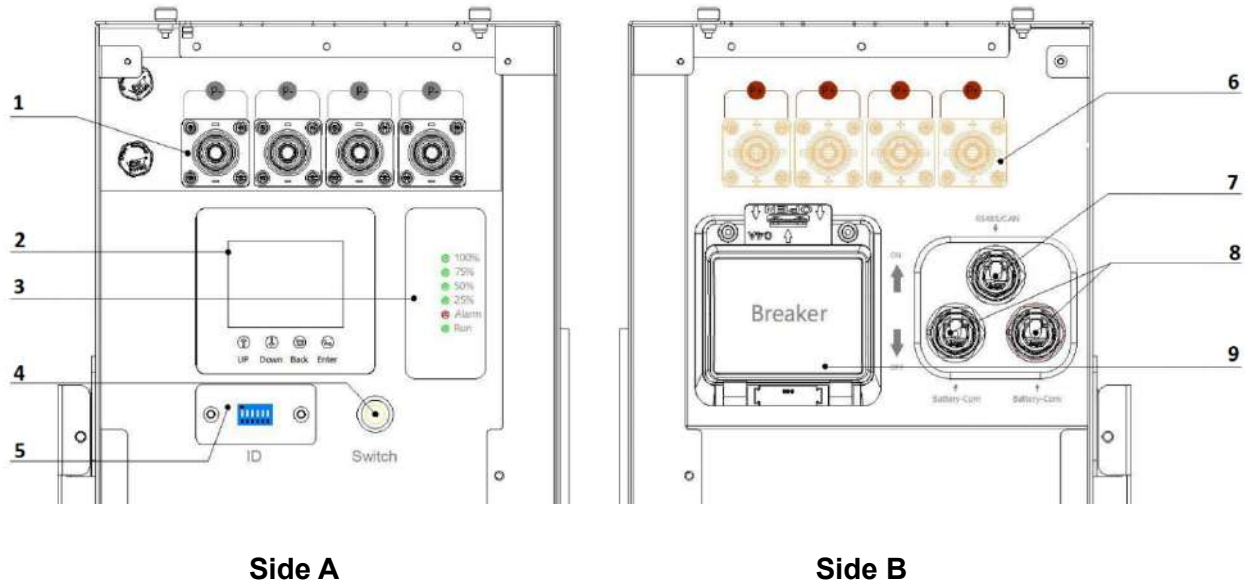

Figure 2: Battery diagram (side view)

No.	Item	Description	Remarks
1	Negative Terminals	Connects to negative terminal of Inverter and/or paralleled battery	
2	LCD Screen	Shows battery information	
3	SOC Display	State of Charge LED	
4	Power Switch	Turns BMS on/off	
5	ID/DIP Switch	DIP Switch board for BMS	
6	Positive Terminal	Connects to positive terminal of Inverter and/or paralleled battery	
7	RS485/CAN Port	RS485/CAN Communication Interface	Pin 1 & Pin 8 – RS485_B Pin 2 & Pin 7 – RS485_A Pin 4 – CAN_H Pin 5 – CAN_L
8	Battery-Comm	Parallel battery Communication Port	Pin 1 & Pin 8 – RS485_B Pin 2 & Pin 7 – RS485_A Pin 3 & Pin 6 – E-Stop NO
9	Battery Disconnect Breaker	Turns power supply on/off	Double Pole Single Throw 125 Frame size 125 Amp Rating

6. Location Selection and Installation

Warning

- **Do not put EG4® 48V batteries in series.** The BMS and internal components are not designed to handle this setup, which could cause the modules to fail.
- Do **NOT mix EG4® WallMount 280Ah batteries with any non-280Ah lithium batteries.** This will void your warranty.
- The WallMount is heavy. Use a lift or other equipment to lift and carry the unit
- The WallMount can be installed on either flat ground or on the wall. If installed on flat ground, ensure there is proper drainage on the ground surrounding the battery to maintain integrity of the module over a period of time. If installing on the wall, ensure at least a 12 in. gap on each side of the unit for adequate airflow and operations.
- Install the WallMount in a location that prevents damage from flooding

Important:

- Always mount the battery in an upright position
- WallMount must be installed with clearance at the left, right, top, bottom, and front of the product for easy installation and safe operation of the unit as shown in the above picture.
- Ensure at least 12 in. between multiple WallMounts and other devices, unless it is installed as a part of PowerPro WallMount ESS that includes EG4-18kPV with the conduit box. In a PowerPro WallMount ESS installation, the conduit box is attached directly to both battery and inverter.
- Please follow NEC and other local codes while installing the product.

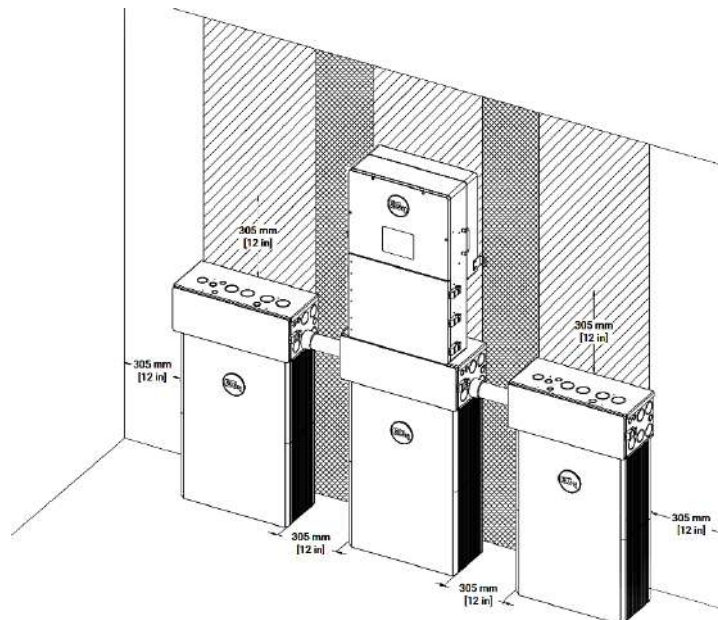

The battery can be installed in multiple different configurations:

- 1) Installation without a conduit box (Sec 6.2)
- 2) Installation with a conduit box (Sec 6.3)
- 3) Installation with EG4 18kPV inverter (Sec 6.4)

Refer to [Section 7.3](#) for multiple battery installations with multiple EG4-18kPV units.

6.1 Outdoor Conduit Box Installation* (sold separately)

The conduit box is a highly recommended accessory for the battery to retain all the cables inside an enclosure for added protection and safety. The conduit box holds both the conduits and wires that are running between the inverter and the battery.

Figure 3: Cross-sectional views of the conduit box

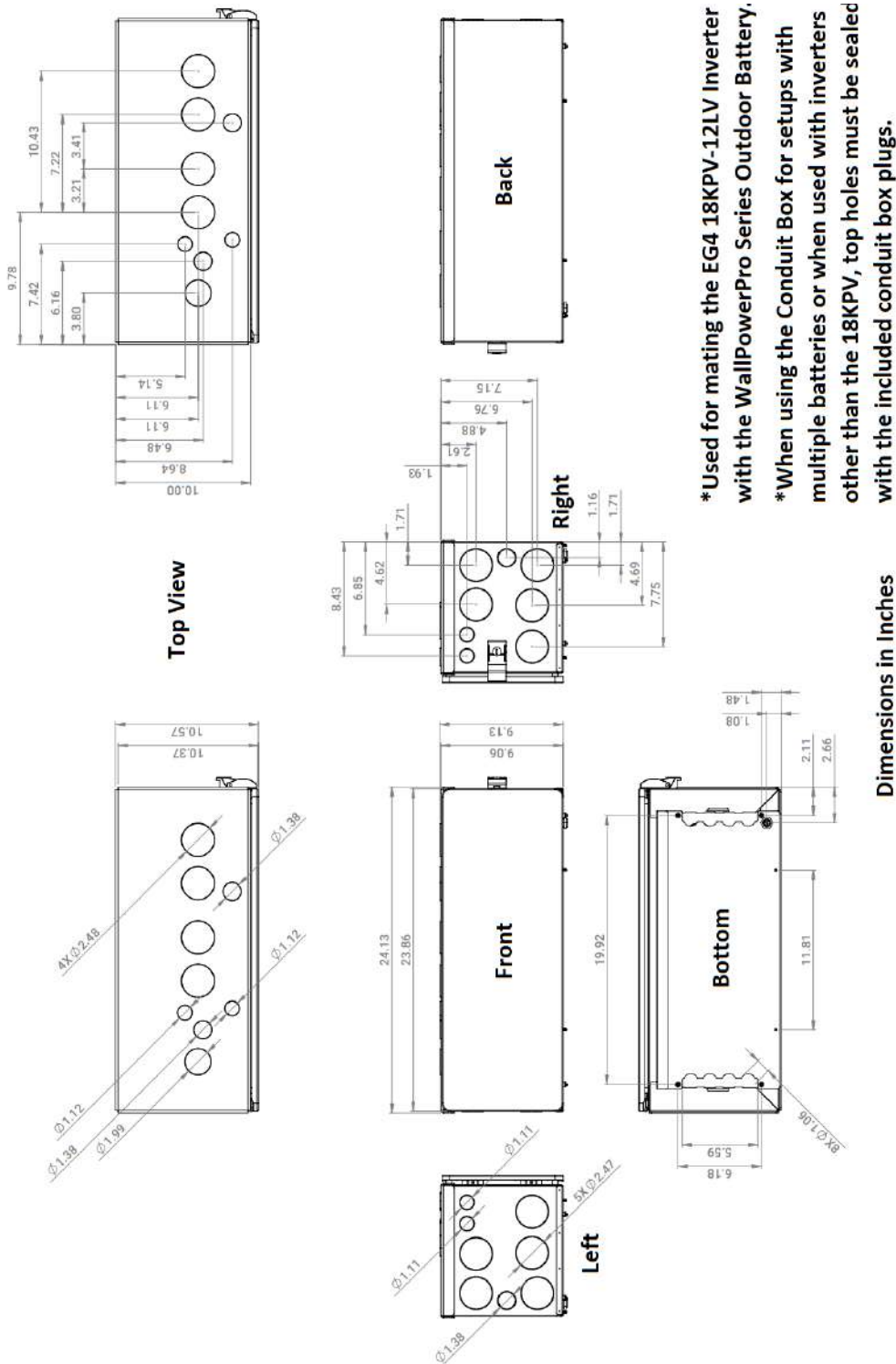

Each Conduit box comes with 8 thumb screws that can be used to attach the inverter and the battery.

Step 1: Identify the four screw locations that attach to the battery (**Figure 4**). Place the conduit box on top of the battery and use the provided thumb screws to tighten the conduit box to the battery.

Figure 4: Conduit Box with 4 thumb screws mounting to the battery

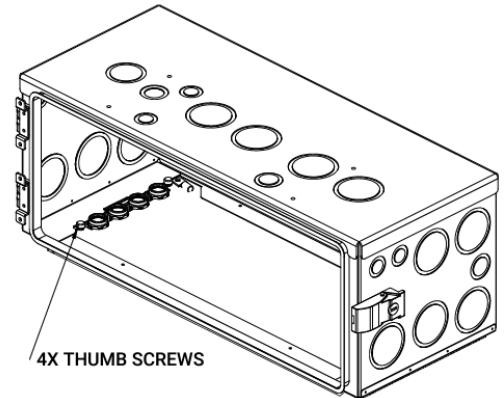

Step 2: If you are installing the WallMount along with the 18kPV inverter (Sec 6.4), please use the remaining 4 thumb screws to the top side of the conduit box to the inverter, as shown in **Figure 5**.

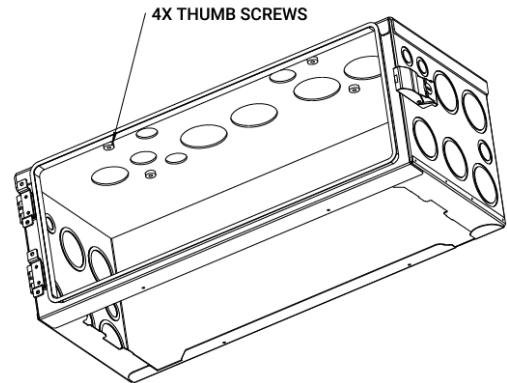

Figure 5: Conduit Box with top

If you are installing the WallMount as an additional battery or along with non-EG4 18kPV inverter (Section 6.3), please use the plugs to cover the top holes on the conduit box. Refer to **Figure 6**.

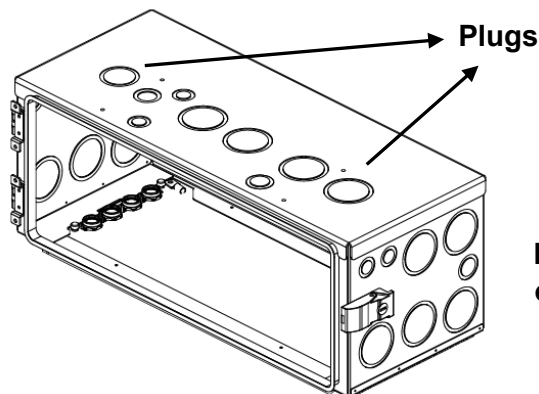

Figure 6: Conduit Box with the plugs on the top

6.2 Installation Without a Conduit Box

Mounting Instructions

- Place mounting bracket on wall at proper mounting height (Min. 28.0625 in) from the ground; use a Level to make sure the bracket is straight, and mark mounting hole locations. Drill holes to accommodate mounting hardware being used.
Note: The mounting bracket at 28.065in from the ground makes the battery sit on the ground.
- Secure mounting bracket to the wall using the included expansion bolts (concrete/brick walls) or appropriate hardware required for the mounting surface.
Note: *If not mounting into concrete or brick using the included expansion bolts, ensure bolts are mounted into both studs or other supportive material. The battery is 300lb, please ensure full mounting support.*
- Attach the EG4® WallMount battery pack to the mounting bracket. To accomplish this, lift the battery up and hook the flange on the back of the battery into the flange on the front of the mounting bracket. Secure the battery to the mounting bracket with the 4 included side screws (see diagram showing “Secure” points - step 3 on following page)
Note: *The battery is very heavy. Please use the team lift technique to prevent damage to personnel and/or equipment*
- Finally, properly ground the battery, attaching a grounding conductor to the M6 grounding screw on top of the battery to the Equipment Grounding System.

Figure 7: Installation of WallMount without a conduit box

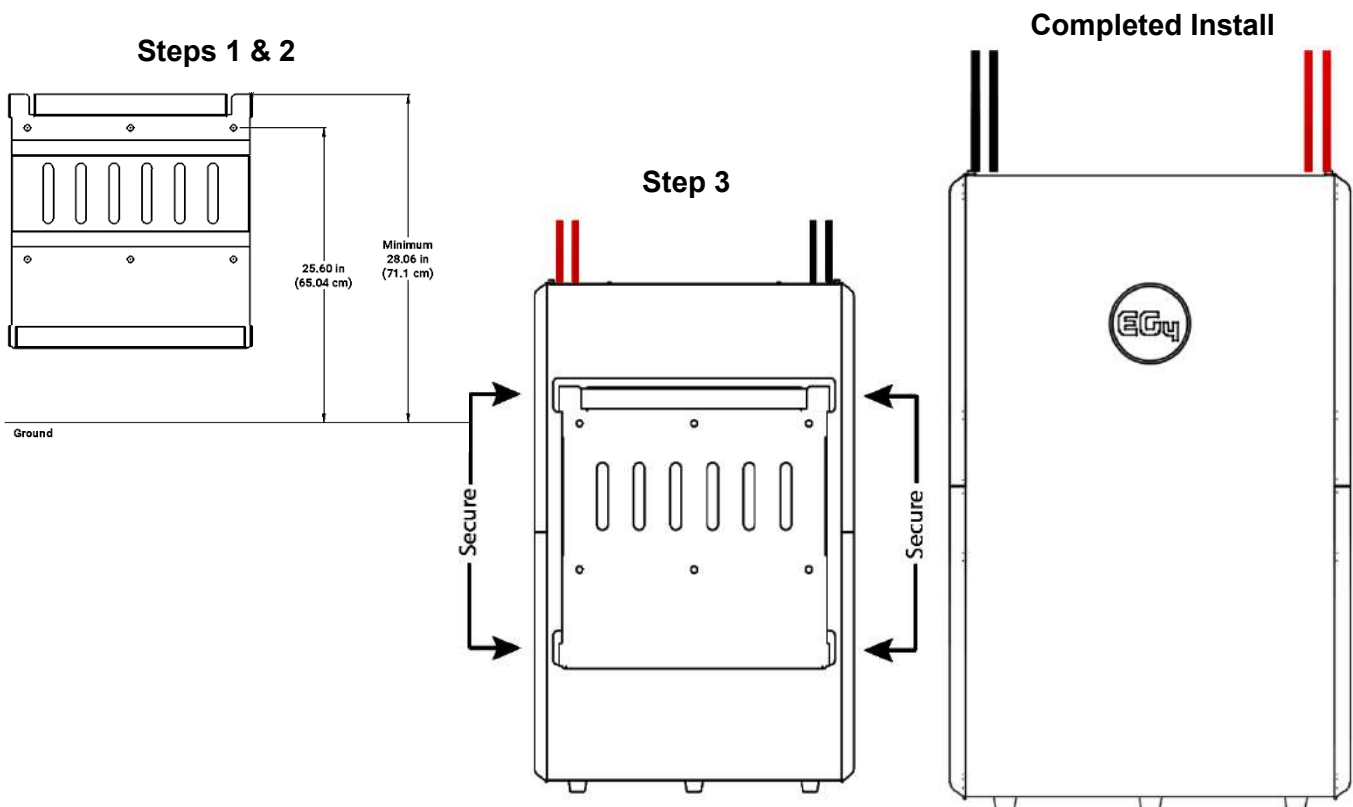

6.3 Installation With a Conduit Box

Attach the conduit box (sold separately) to the top of the WallMount battery using the included hardware. Refer to Section 6.1 for the conduit box installation instructions.

Mounting Instructions

- Place mounting bracket on wall at proper mounting height (Min. 28.0625 in) from the ground; use a Level to make sure the bracket is straight, and mark mounting hole locations. Drill holes to accommodate mounting hardware being used.
Note: *The mounting bracket at 28.065in from the ground makes the battery sit on the ground.*
- Secure mounting bracket to the wall using the included expansion bolts (concrete/brick walls) or appropriate hardware required for the mounting surface.
Note: *If not mounting into concrete or brick using the included expansion bolts, ensure bolts are mounted into both studs or other supportive material. The battery is 300lb, please ensure full mounting support.*
- Attach the EG4® WallMount battery pack to the mounting bracket. To accomplish this, lift the battery up and hook the flange on the back of the battery into the flange on the front of the mounting bracket. Secure the battery to the mounting bracket with the 4 included side screws (see step 3 in following diagrams)
Note: *The battery is very heavy. Please use the team lift technique to prevent damage to personnel and/or equipment*
- Attach the conduit box (sold separately) to the top of the WallMount battery using the included hardware.
- Finally, properly ground the battery, attaching a grounding conductor to the M6 grounding screw on top of the battery to the Equipment Grounding System.

Figure 8: Installation of WallMount with a conduit box

Steps 1 & 2

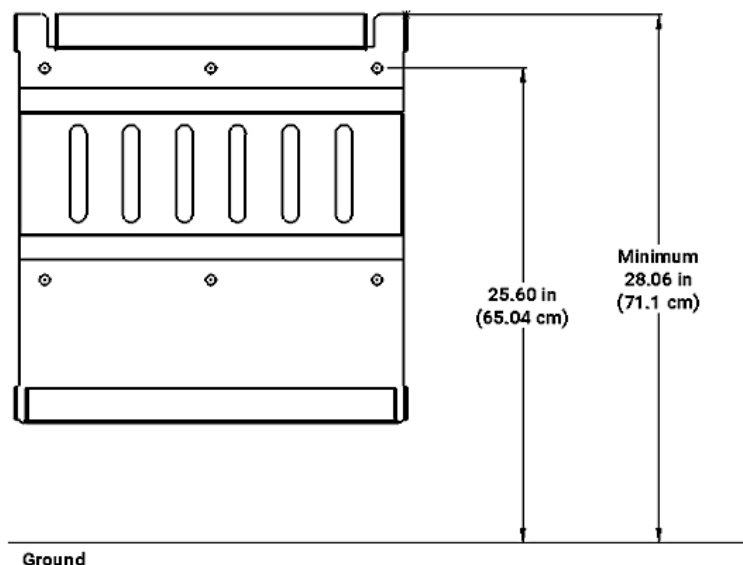

Step 3

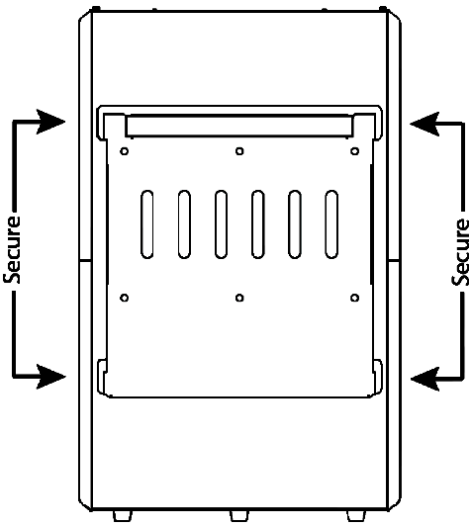

Step 4

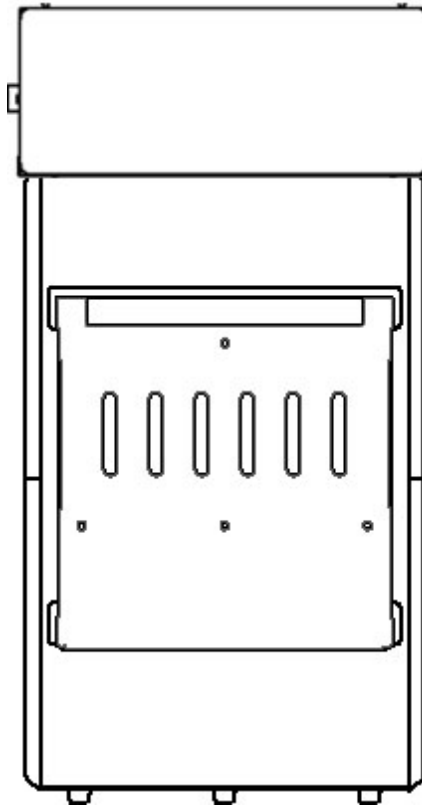

Final-Front View

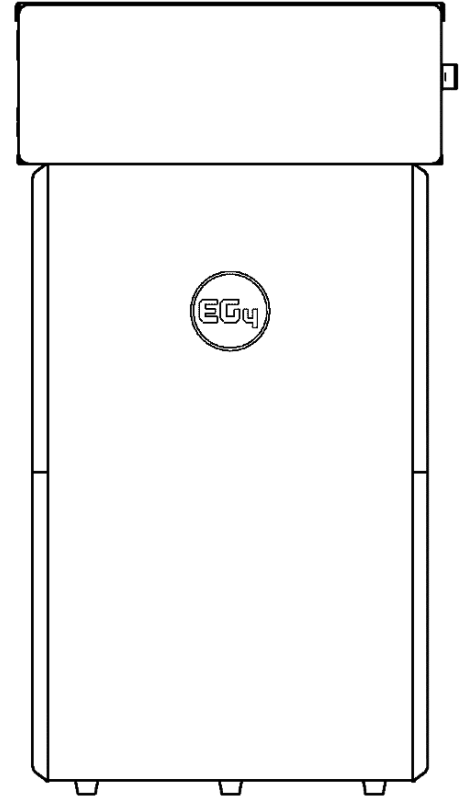

6.4 With EG4 18kPV Inverter

Mounting Instructions with EG4 18kPV (See Diagrams on Following Pages)

Note: If **not** mounting into concrete or brick using the included expansion bolts, ensure bolts are mounted into both studs or other supportive material. The battery is 300lb, please ensure full mounting support.

- Place mounting bracket on wall at proper mounting height (Min. 28.0625 in) from the ground; use a Level to make sure the bracket is straight, and mark mounting hole locations. Drill holes to accommodate mounting hardware being used.
Note: The mounting bracket at 28.065in from the ground makes the battery sit on the ground.
- Align the provided X-bracket with the holes on the mounting bracket and secure both to the wall, using the included expansion bolts (concrete/brick walls) or appropriate hardware required for the mounting surface. The X-bracket will be behind the mounting plate, against the wall.
- Using the X-bracket as a guide, attach the EG4® 18kPV mounting bracket using the appropriate hardware required for the mounting surface.
- Attach the EG4® WallMount battery pack to the mounting bracket. To accomplish this, lift the battery up and hook the flange on the back of the battery into the flange on the front of the mounting bracket. Secure the battery to the mounting bracket with the 4 included side screws (see step 4 in following diagrams).
Note: The battery is very heavy. Please use the team lift technique to prevent damage to personnel and/or equipment
- Attach the conduit box (sold separately) to the top of the WallMount battery using the included hardware.
- Attach the 18kPV to the inverter mounting bracket making sure that the holes of the inverter align with the conduit box and secure to each other with the included hardware.
- Finally, properly ground the battery, attaching a grounding conductor to the M6 grounding screw on top of the battery to the Equipment Grounding System.

Figure 9: Installation of WallMount with EG4-18kPV inverter

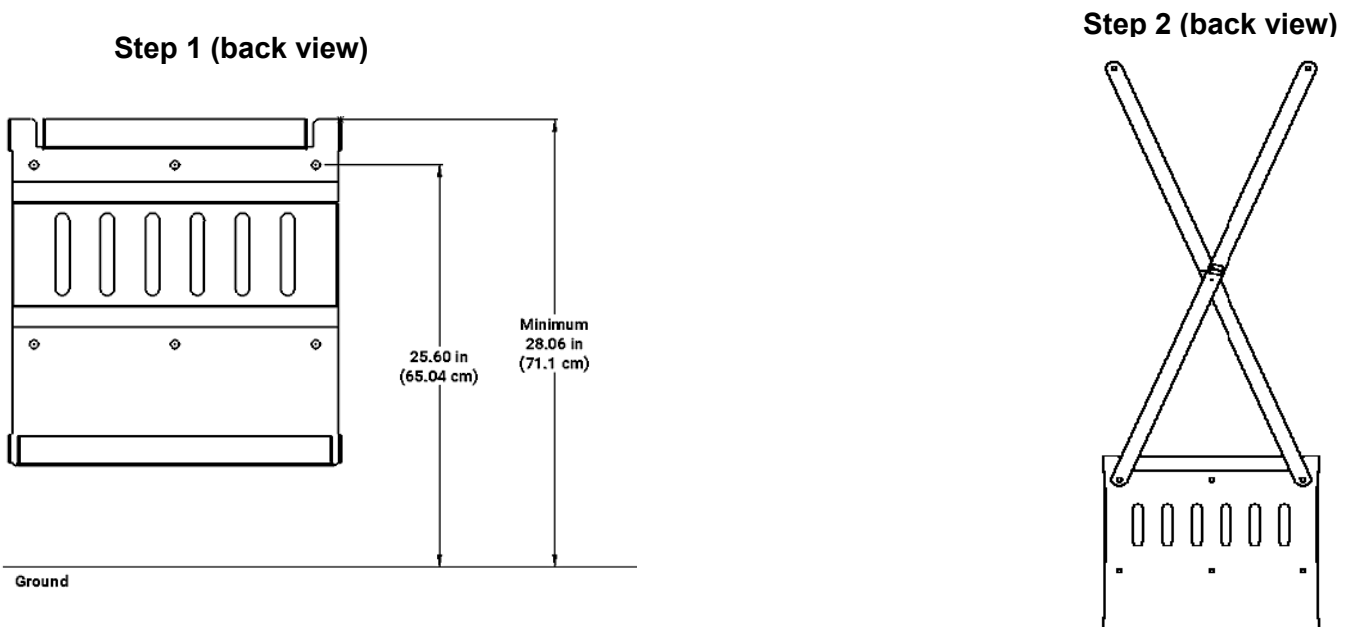

Installation continued...

Step 3 (back view)

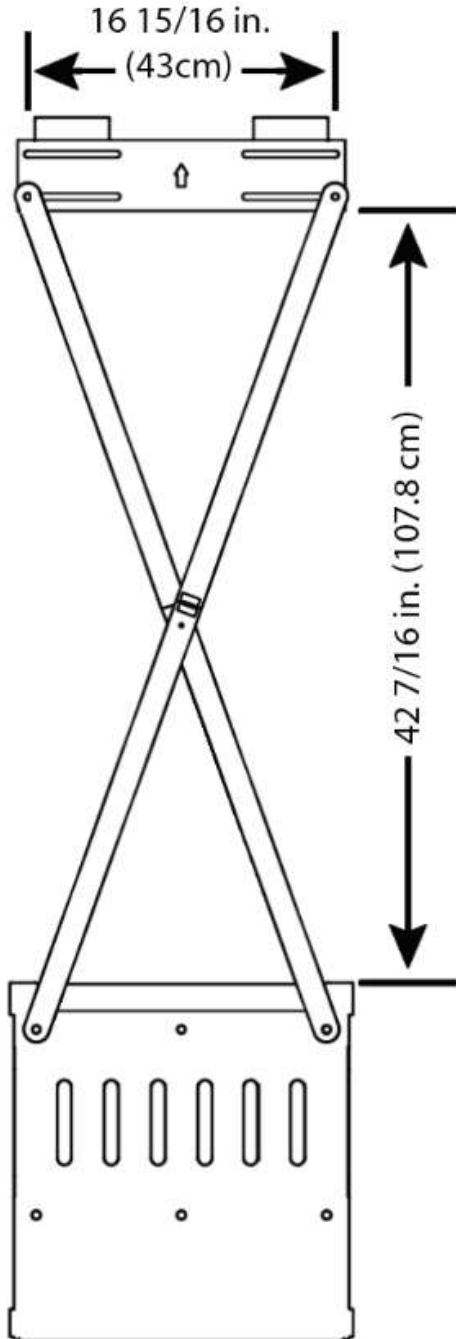

Step 4 (back view)

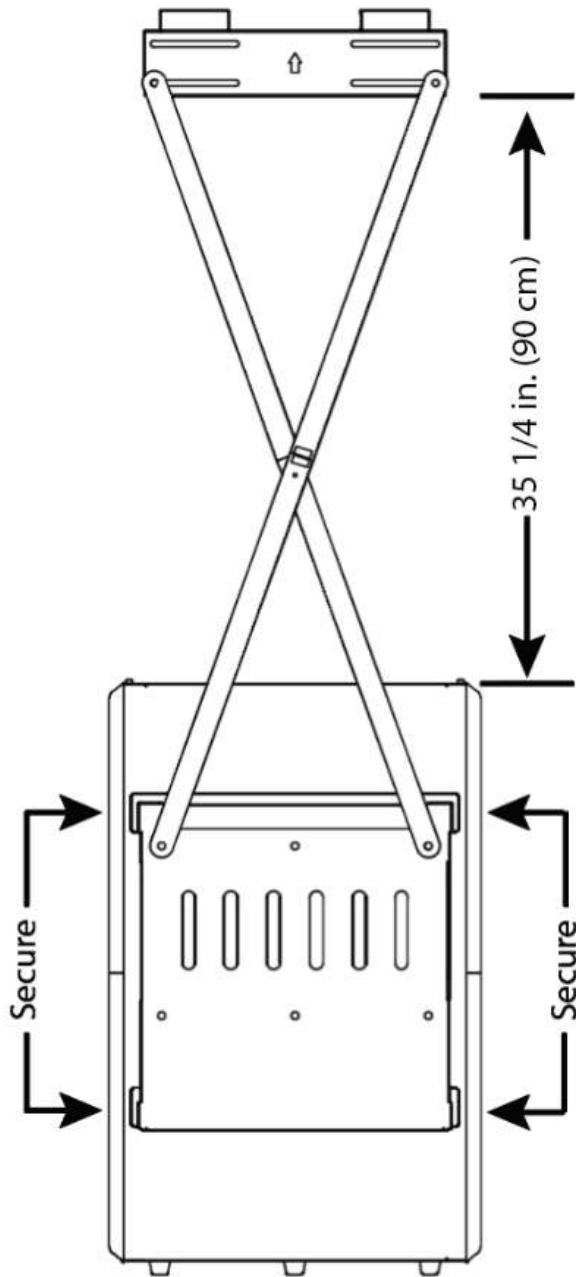

Step 5 (back view)

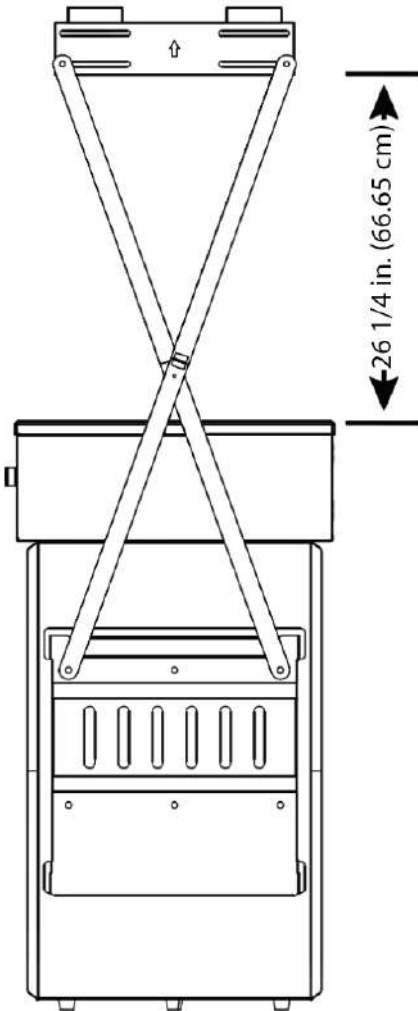

Step 6 (back view)

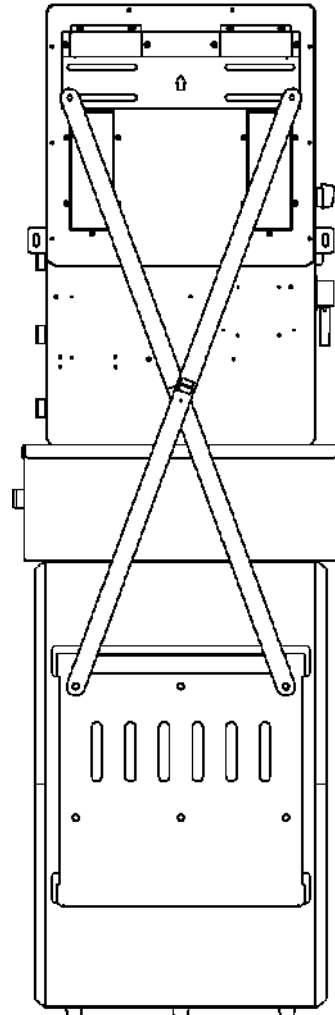

Final - Front View
w/ Dimensions

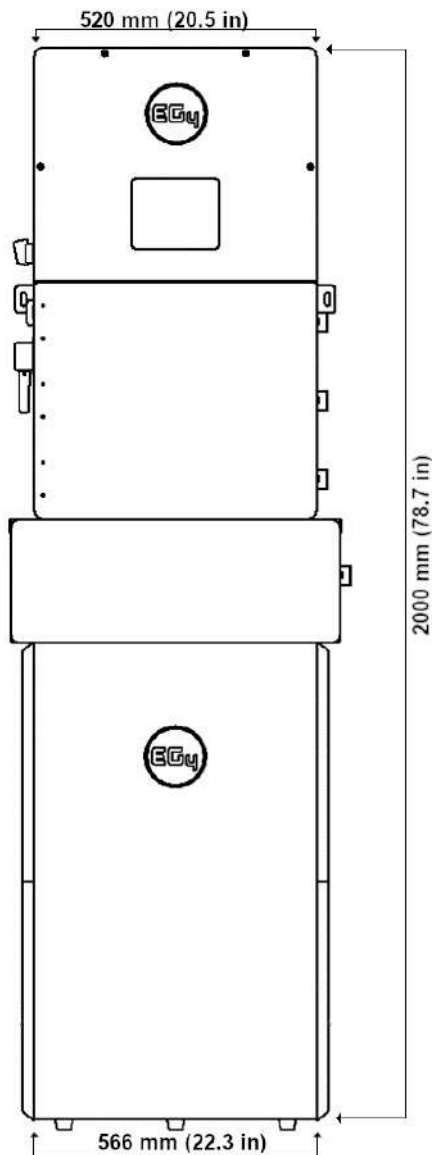

7. General Installation



Warning!

Be sure your battery packs are powered “OFF” before making/removing any connections.

Use the two included sets of 2/0 AWG (70mm) outdoor rated positive and negative battery cables with the outdoor rated connectors. The connectors will “click” when seated properly.

Note: To remove the circular connector installed on the battery, first depress the release button on the side of the connector, then slowly pull until the connection is broken.

When paralleling batteries, use one set of 2/0 AWG (70mm) positive and negative battery cables with outdoor rated connectors on both ends to connect battery to battery. These cables are available from your distributor as a paralleling kit.

When paralleling batteries, use a communication cable to attach the master battery to additional batteries for battery-to-battery communication. This cable is also available from your distributor in the paralleling kit.

7.1 Battery Paralleling Guide

1. Ensure all battery breakers and BMS are OFF.
2. Set the address code of each battery according to the DIP Switch ID Table (see [Section 9.1: DIP Switch ID Table](#)), making sure there are no duplicate addresses.
3. Set up communication between the batteries via the “Battery-Comm” ports of each battery. Use the paralleling kit communication cable to daisy chain all paralleled batteries in the bank together. See diagram below for example.

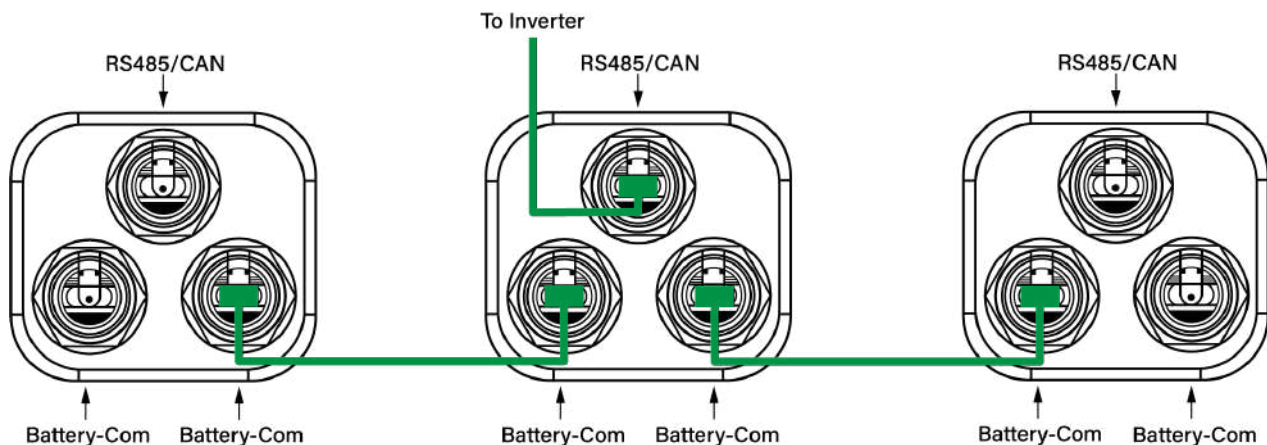

4. The battery with DIP Switch ID 1 (referred to as the master) connects to the inverter via a properly pinned communication cable (depending on inverter) using the RS485/CAN port.
5. Install battery paralleling cables between batteries. Refer to [Section 7.2 Battery Cable Connections](#) for battery cable connection diagram examples.
6. Once all cable connections are completed and the system is ready to be commissioned, power on each battery breaker and BMS ON/OFF switch one at a time beginning with the master battery.

7.2 Battery Cable Connections

The following battery cable connection diagrams are examples using the internal busbars to parallel the batteries together and attach the inverter(s) to the batteries. When relying on the internal integrated busbars, up to 3 batteries are supported in parallel when connected to a single inverter or 4 batteries in parallel when connected to 2 inverters, or up to 5 batteries in parallel when connected to 3 inverters.

Systems with more batteries than these configurations **require** the use of an external fused positive busbar and an unfused negative busbar rated at a minimum of 200A per battery. Each fuse should be a maximum of 250A. Alternatively, larger systems could rely on the 18kPV's ability to draw from different battery packs while still paralleling inverters rather than utilizing external busbars.

The maximum recommended number of paralleled 18kPV inverters is 6. If this approach is used, we recommend a ratio of 3 batteries per pack controlled by each 18kPV inverter. Separating packs is only recommended if each pack's average SOC is monitored over time and does not diverge by more than 10%. Common busbars are superior to separating battery packs but it may be difficult to source fused positive busbars rated to greater than 1800 Amps. This translates into separating packs larger than 9 batteries. *Refer to NEC code and your local AHJ for exact requirements*

Note: *In the following diagrams, units are spaced 12 in. apart. Local regulations may require a larger minimum battery spacing. Check with your AHJ for these requirements. If longer parallel cables than are available in the optional paralleling kit are necessary, please check with your distributor for availability.*

(1) 18kPV Inverter w/ (1) WallMount

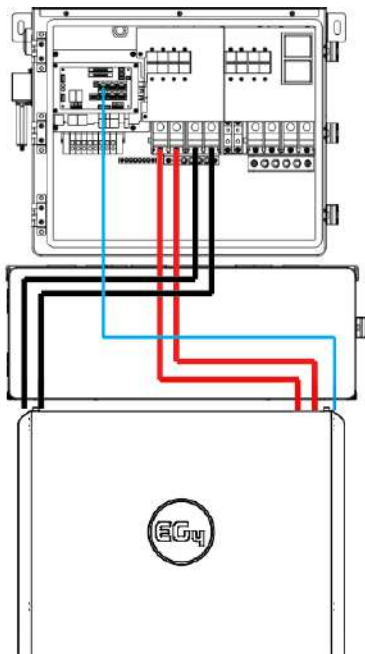

Note: To comply with the UL9540 listing for this integrated battery, conduit box, and inverter system, the batteries must be wired as shown using the supplied inverter to battery cables. *An additional paralleling kit is required for each additional paralleled battery (sold separately).*

Caution: *To minimize the voltage drop in the wire, the battery cables should maintain optimum length. The 53.1in cables from the "parallel kit" are sufficient to daisy chain the batteries.*



7.3 Additional Configurations

Figure 10: Additional WallMount and EG4-18kPV installations

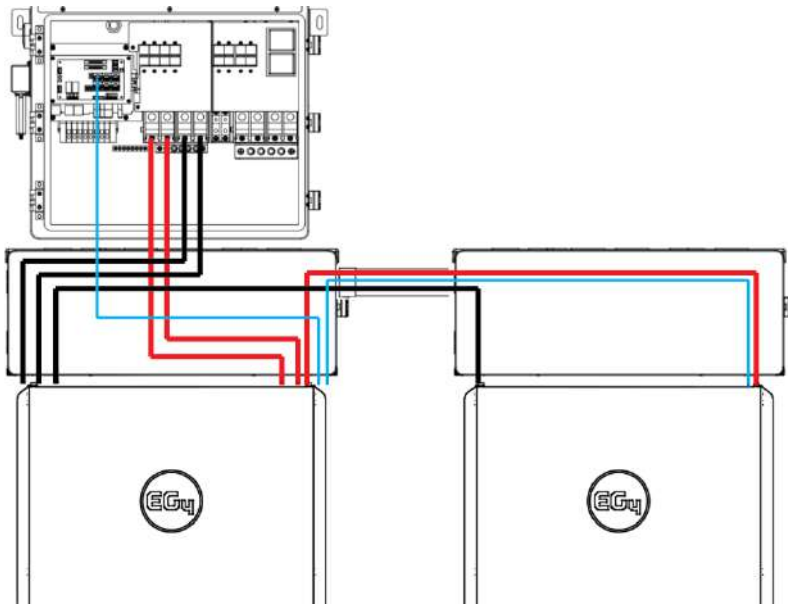
(1) 18kPV Inverter w/ (2) WallMount



Color Code

	— Parallel/Comm
	— Positive
	— Negative

(1) 18kPV Inverter w/ (3) WallMount

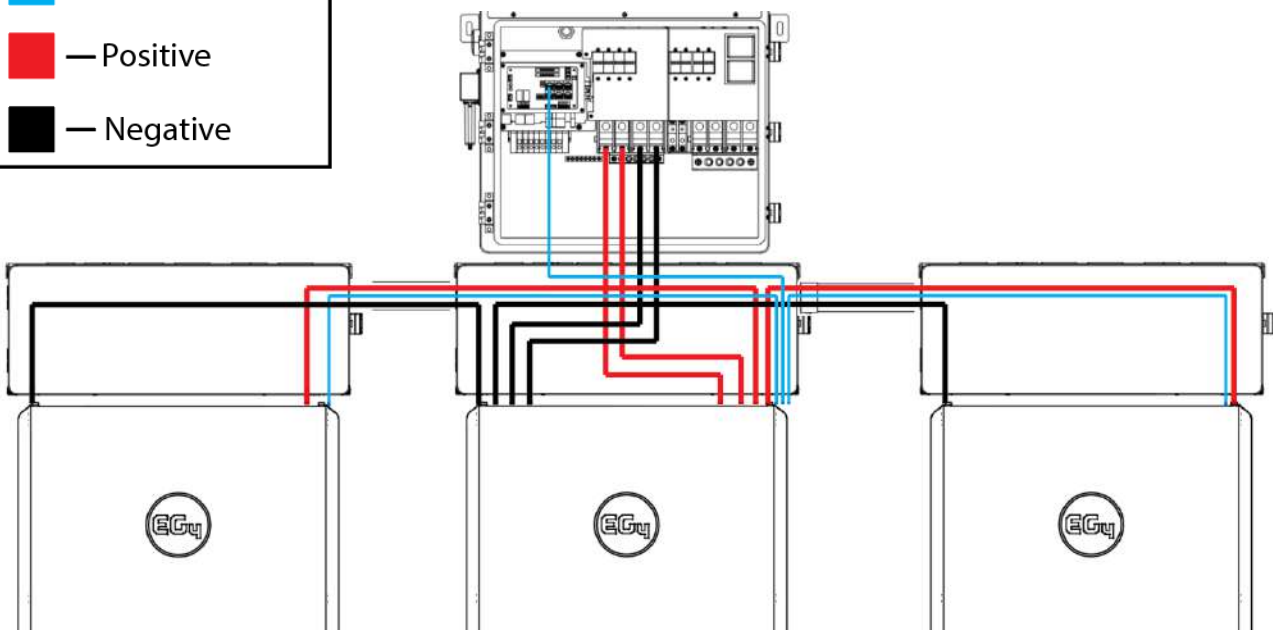

Note: Some configurations require additional wiring/connectors to achieve the example layouts.

Other configurations can be achieved through the use of external busbars.

Please seek the guidance of an electrician or qualified person for optional system layout.

Pro Tip: One EG4-18kPV and a minimum of 2 WallMount units is the recommended configuration to maximize the inverter's functionality

Note: The separation between batteries should be 12 in. or more.

(2) 18kPV Inverter w/ (2) WallMount

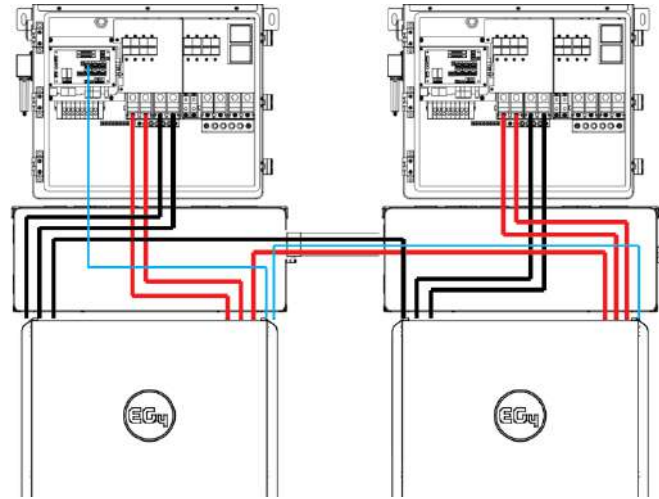

(2) 18kPV Inverter w/ (3) WallMount

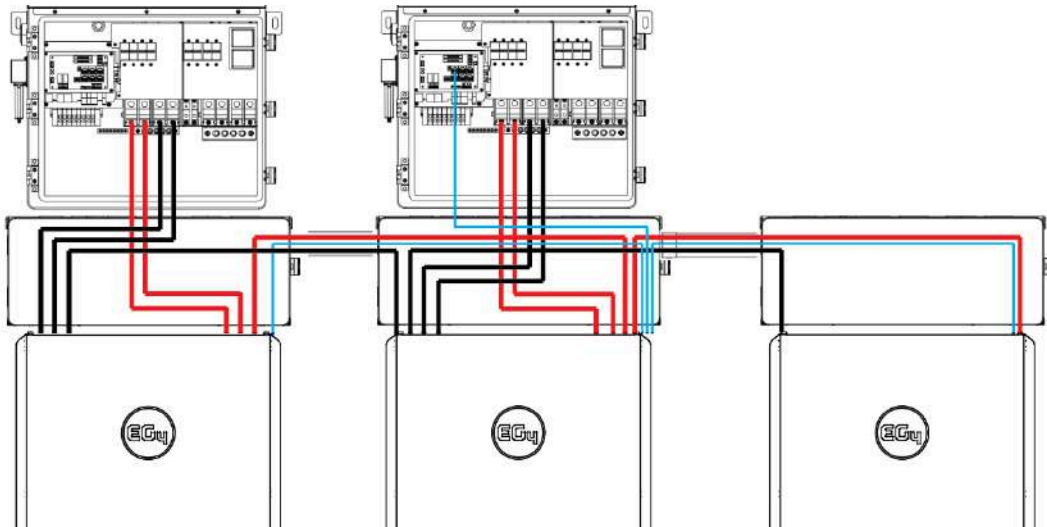

(2) 18kPV Inverter w/ (4) WallMount

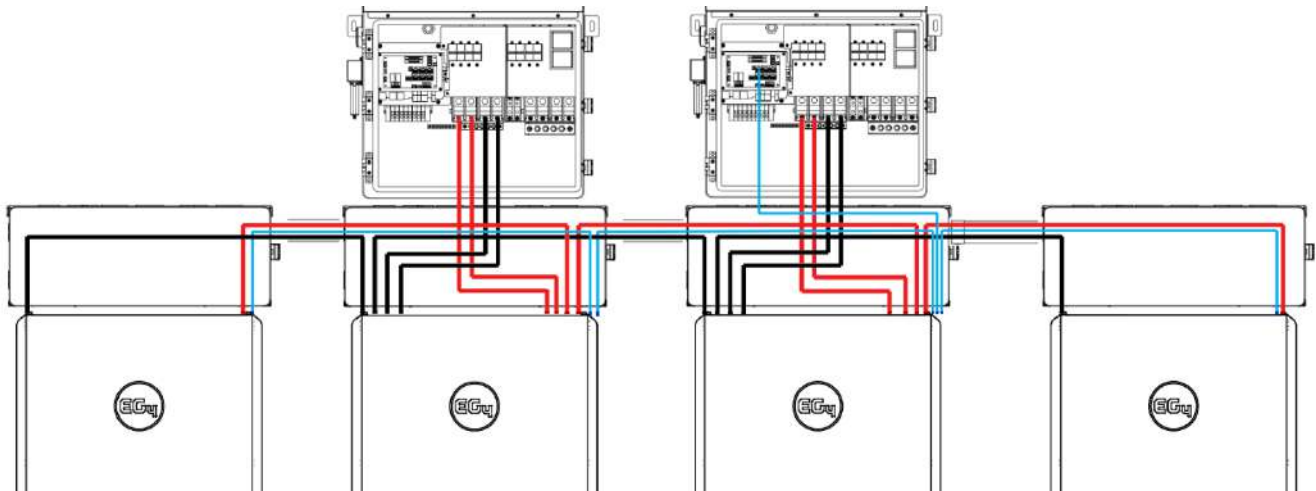

(3) 18kPV Inverter w/ (3) WallMount

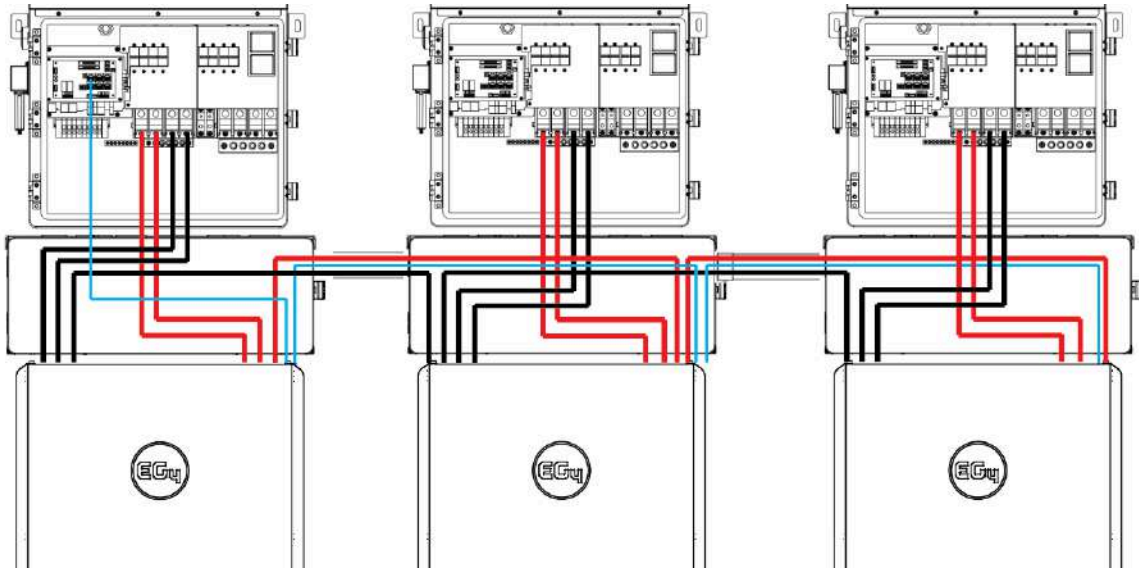

(3) 18kPV Inverter w/ (4) WallMount

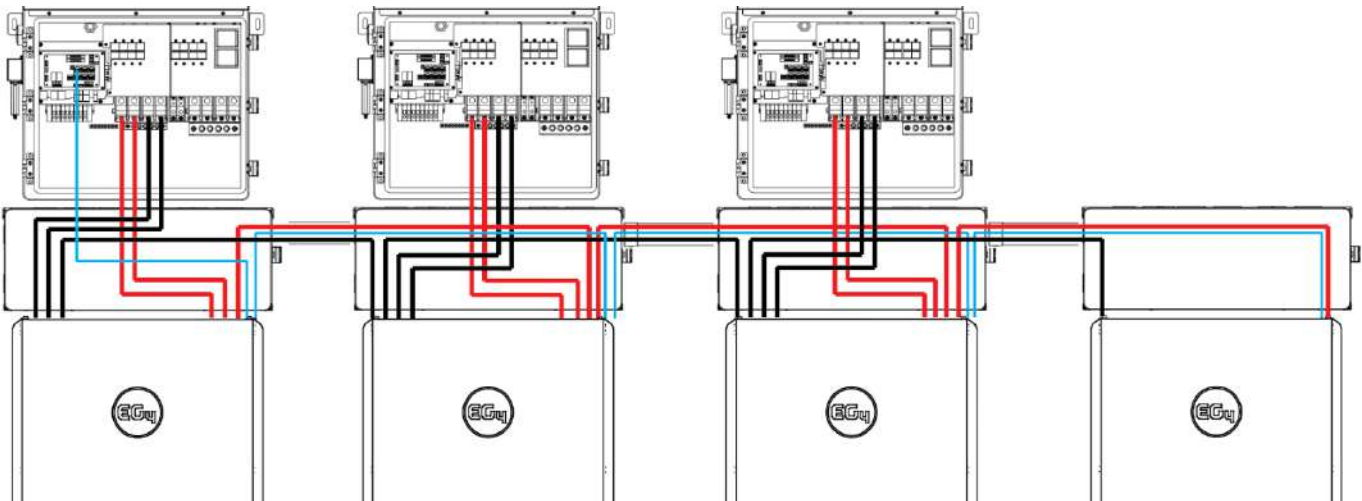

8. Emergency Stop (RSD, ESS Disconnect)

Figure 11: Emergency Stop connections WallMount

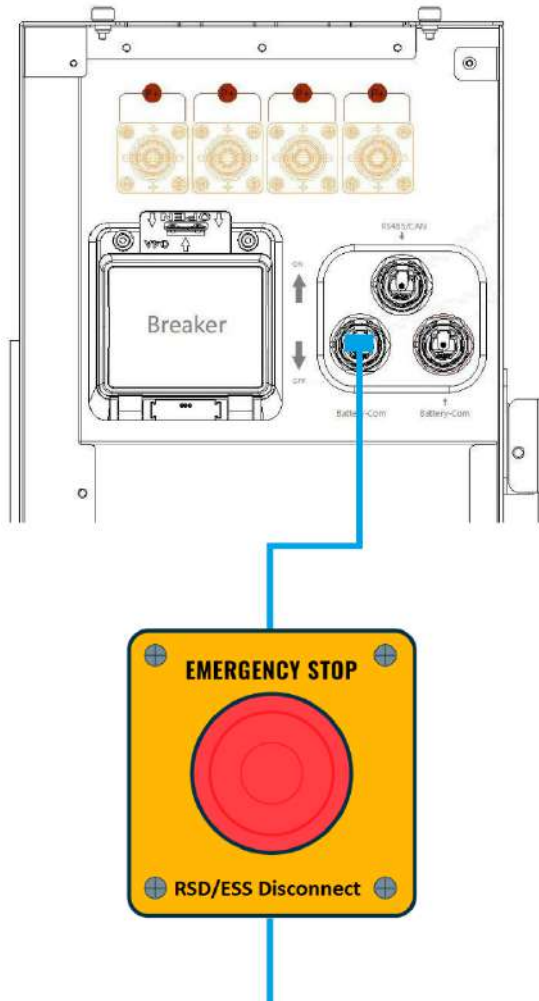

To Inverter, RSD Initiator, or ESS Disconnect

(Inverter recommended if compatible with Inverter's RSD system)

Normally Open (NO) Contacts Depending on the Inverter

The optional ESS disconnect can be used to shut down all batteries and inverters (if equipped) with the push of a button.

When paralleling multiple batteries, the ESS disconnect only needs to have connections made with the master battery.

This integrated safety feature ties directly into the battery communication system via an open Battery-Com port using a standard Cat-5/6 ethernet cable.

Pins 3 & 6 are used to communicate the emergency stop information to the batteries once the stop button is pressed.

If the inverter is equipped with rapid shut down (RSD) capabilities, the emergency stop feature can be used to initiate this function. Check with your AHJ and NEC code for compliance.

9. Battery Communications

Each EG4® battery is designed with you in mind, displaying as much information as possible in the simplest manner. EG4® Electronics includes the option of connecting the battery to PC software to monitor the module status. This allows the user to see and understand exactly what the battery is doing as well as troubleshoot if problems arise.

The master battery will communicate directly with the system via the RS485/CAN port.

9.1 DIP Switch ID Table

EG4® batteries interface with an inverter by designating a “Master” battery (DIP switch ID No. 1). The available ID codes range from 1–64. The battery will connect directly to the inverter via a RS485 battery communications cable or a standard CAT 5, 5e, or 6 cable for closed loop communications with supported non-EG4® inverters using CAN bus protocol.

Remember

If you have multiple batteries, all DIP switch settings **must** be different from each other. This allows all equipment to see each battery in the bank separately. For best practice, place IDs in sequence starting with ID 1 as the master battery.

Figure 12: DIP switch ID table

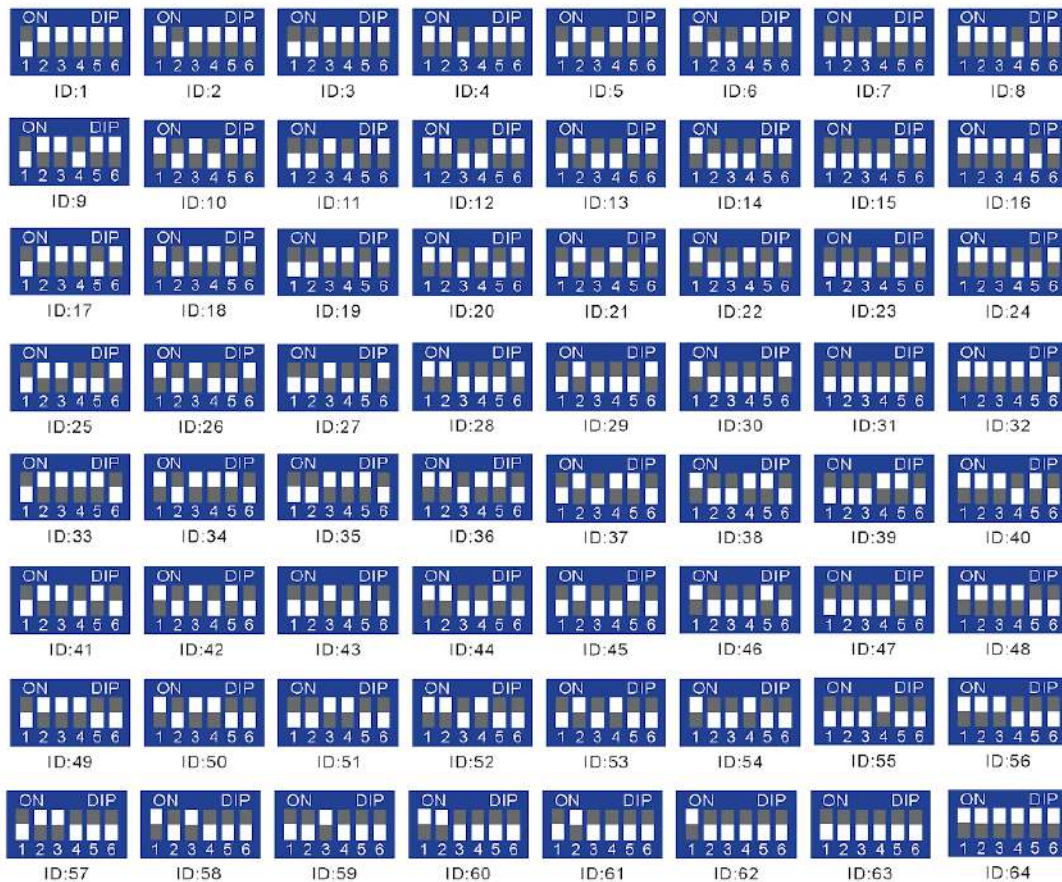

9.2 LCD Screen

Each module has a built-in HD LCD touch screen used to display important information about the cells including voltage, current, temperature, SOC, among others.

Button description

There are 4 function buttons below the display with detailed descriptions, as shown in the table below.

Figure 13: LCD screen button description



Waking up the LCD screen

Press any key to wake up the screen when the power is on, and the information will be shown on the display.

Main Page Information

No.	Module Description
1	Battery Name
2	Status
3	Voltage
4	Current
5	System Date & Time
6	SOC

Figure 14: LCD Screen Features



Temperature Information

Press “Enter” on the Cell Voltage page to view the temperature information of the PCB and individual cells (shown in °C)



Cell Information

Check individual cell voltage by pressing the “Enter” button on the main page of the LCD screen (shown in mV). There are 2 pages. Pressing “Up” and “Down” changes the page.



Page 1

Page 2

9.3 Communication Protocol Selection

! Important

1. Only the master battery (Address 1) should to be set to the inverter protocol; all other batteries must have unique addresses starting at address 2 and ascending in chronological order. You must connect the CAN/RS485 port of the master battery to your inverter’s (or communication devices) BMS communication port.
2. If the end-user is trying to interface with BMS Tools on a Mac laptop or computer, please follow [this](#) link for a comprehensive video walkthrough.

Protocol Change/Selection Procedure

1. Power off all battery DC breakers and BMS power buttons.
Ensure that the voltage between positive and negative busbars is 0V.
2. The inverter protocol can only be changed with the master battery temporarily set to address 64 (all switches ON. After the dipswitch is changed, restart the battery (with only the BMS power button) for the settings to take effect. (See image on right.)
3. On the master battery, press and hold the “Return” key for 5 seconds to enter the “Protocol Setting.”



4. Select the corresponding RS485 program or CAN program, and press Enter.



CAN Protocol	Inverter
P01-GRW	Growatt
P02-SLK	Sol-Ark
P03-DY	Deye
P04-MGR	Megarevo
P05-VCT	Victron
P06-LUX	Luxpower



RS485 Protocol	Inverter
P01-EG4	EG4
P02-GRW	Growatt
P03-LUX	Luxpower
P04-SCH	Schneider

5. Press the “Return” key to return to the main interface.
6. Change the master DIP switch address back to address 1. (See image on right.)
7. Power cycle the master battery, and the BMS will correspond to the protocol selected.



10. Operation Guide

10.1 BMS Tools Installation and Interfacing

The PC software “BMS Tools” provides real-time battery analysis and diagnostics. The battery cannot communicate with BMS Tools and a closed loop inverter at the same time.

Visit eg4electronics.com/downloads to get the latest version of the software for free. It can be found in the “Software and Drivers” section.

SOFTWARE AND DRIVERS

1

BMS Tools(EG4-LL)
This is the BMS software for use with the EG4-LL batteries.

BMS Test(Lifepower4)
This is the BMS software for use with the EG4-LiFePower4 batteries.

USB Cable
This is a driver for the cable connect to our batteries. By when plugged into the computer you are not able to driver you can manually

About Products Distributors Contact Warranty Registration Downloads

Please Note: Our website has recently been updated and some functions and features may be disabled. Please contact us on our contact

2

BMS_TOOLS_2.2.0.zip

1. Once downloaded, locate the file. (*This is typically in the Downloads folder.*)

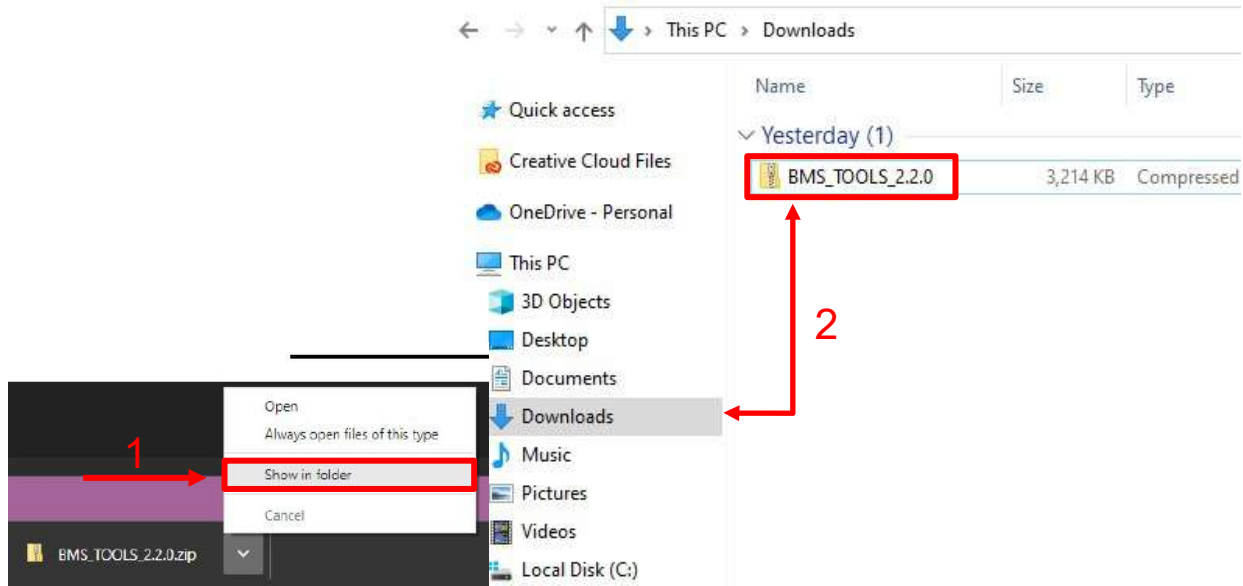

2. Right click on the folder and click “*Extract All.*” Verify the location the file will be extracted to for future reference. Check the box “*Show extracted files when complete*” and click on “*Extract.*”

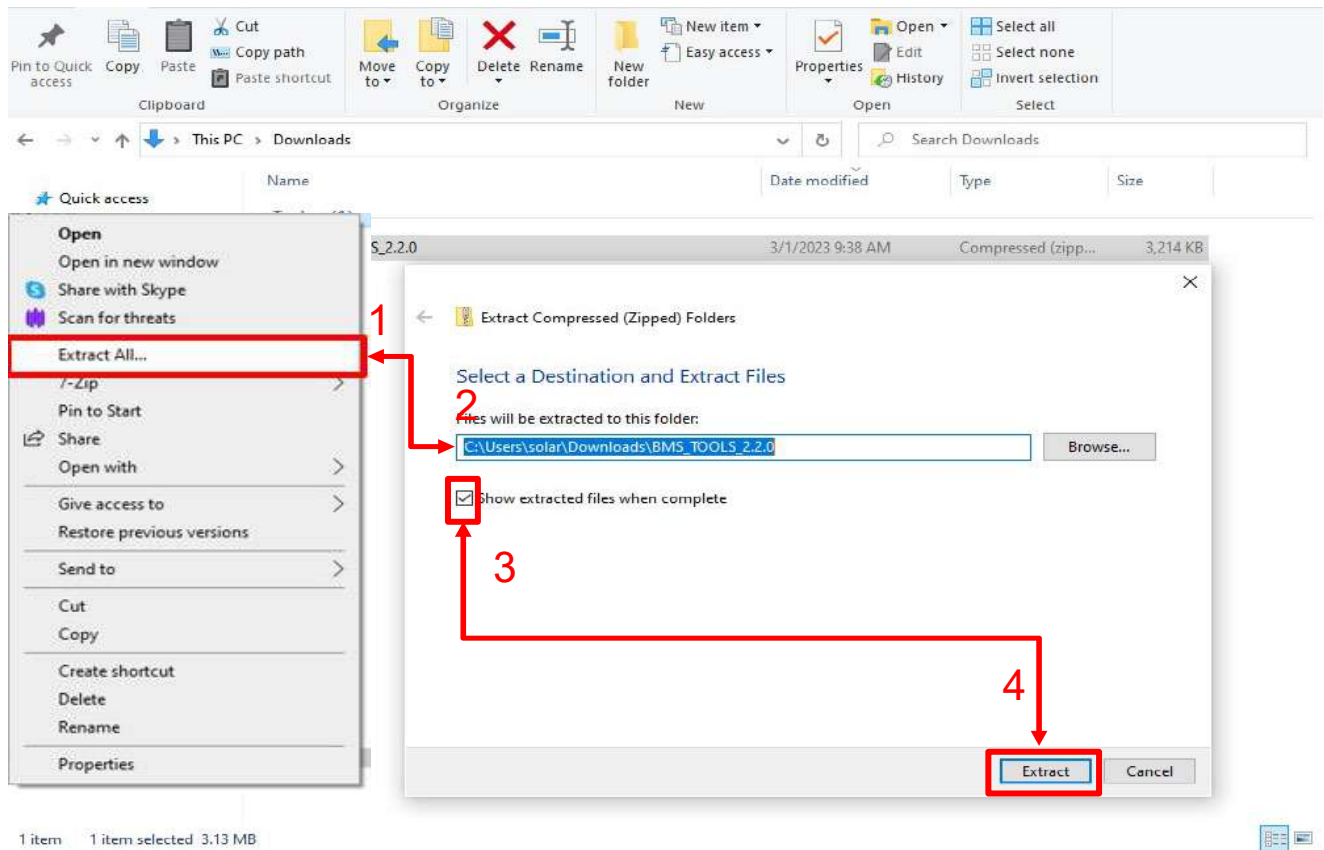

3. Open the folder to access BMS_TOOLS. Right click and click “*Run as administrator.*” You may see a popup for Microsoft Defender appear. Click “*More info,*” and then click “*Run anyway.*”

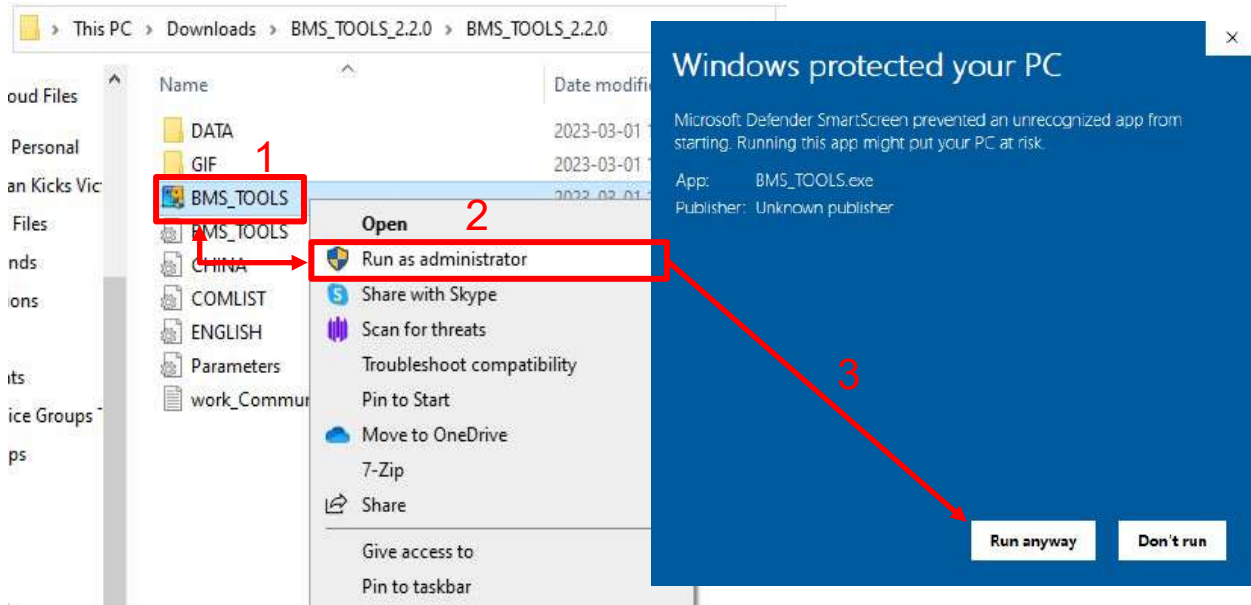

4. You will be brought to the main page of BMS Tools.

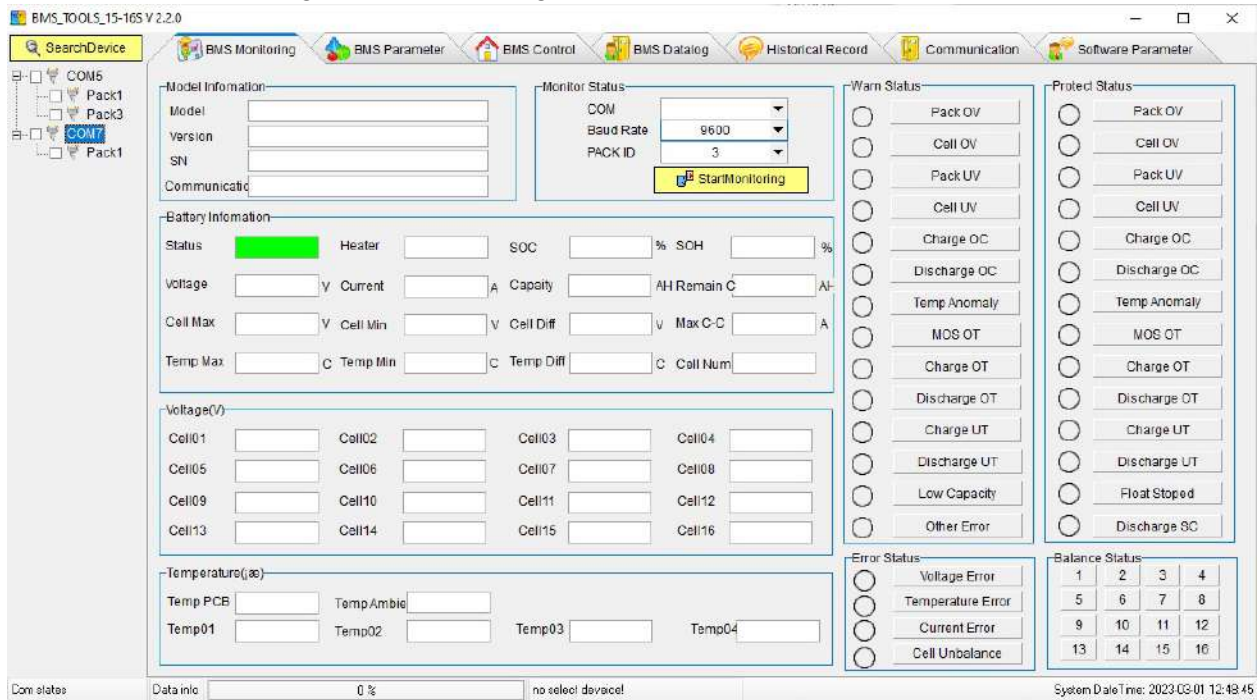

10.2 Interfacing with BMS Tools

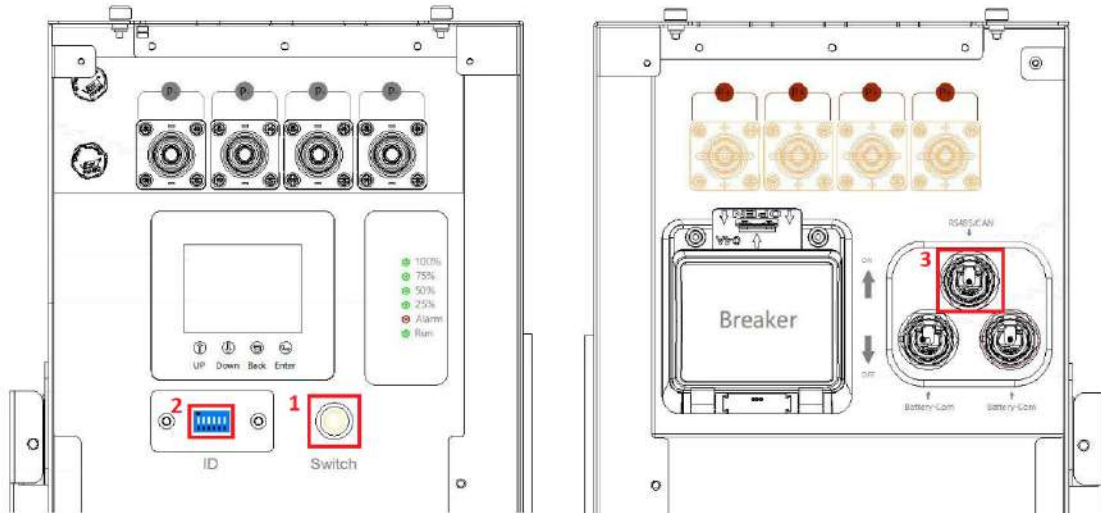

1. Press the ON/OFF button on the battery to power off the BMS.

2. Set the DIP switch ID address of the battery to Address 64 (6-pin DIP, see image to the right).



3. Connect the included battery-to-PC USB cable to your PC and to the RS485 port on the battery. (If BMS Tools is running on your PC, close the program before continuing.)

4. Press the ON/OFF button to power on the battery.

5. In the search bar at the bottom of the PC screen, type “Device Manager.”

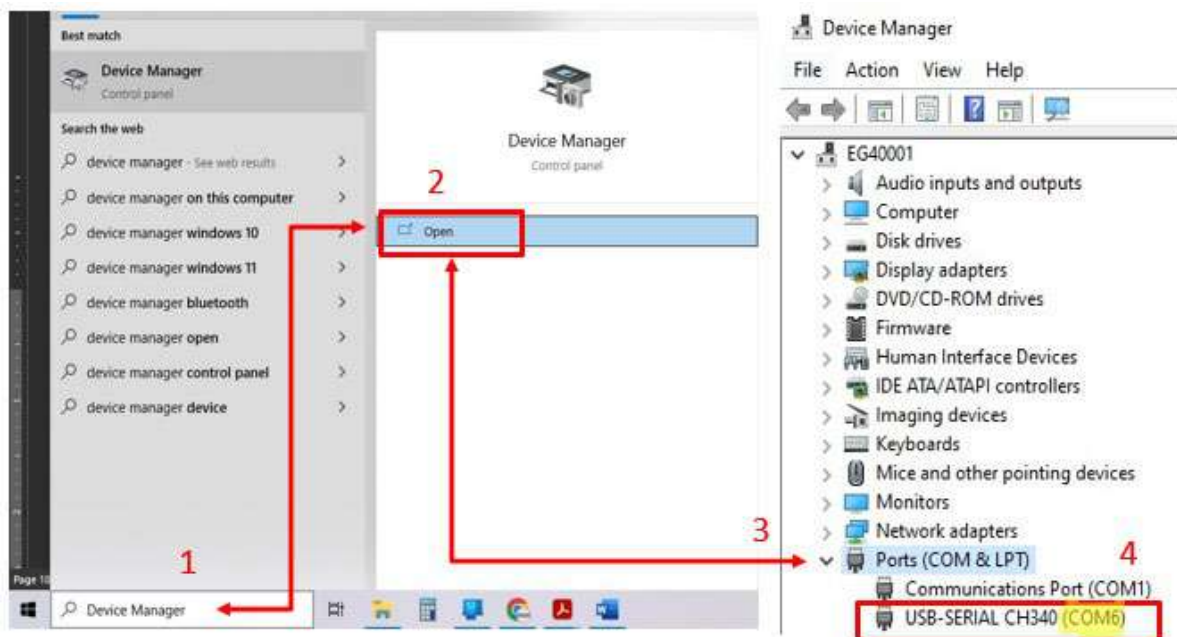

6. Open “Device Manager”, and double click on “Ports” to look for the COM port the battery is in. (See image below.)
7. Open BMS Tools. Under “Monitor Status,” verify “COM” matches the battery COM from the SearchDevice previous “Ports” list. Verify “Baud Rate” is set to 9600, and “PACK ID” is set to 16, then click “.” After about 30 seconds, BMS Tools will begin the monitoring process and pull real-time data from the BMS.

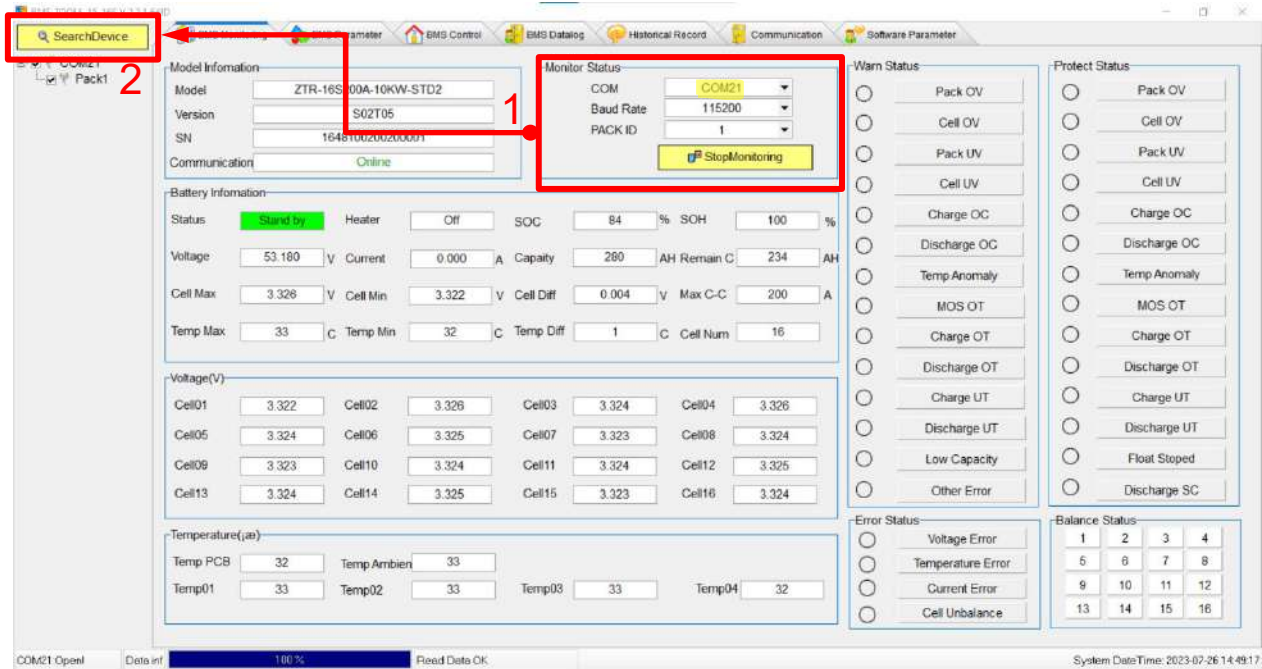

8. To review these steps, please watch our step-by-step guide at https://youtu.be/Axhc8_22Go0.

Warning!

Although there are multiple tabs in the BMS Tools software, the following tabs should not be tampered with as any unauthorized changes **will void the warranty** of this product and risk damaging and/or rendering the product permanently inoperable.

• **BMS Parameter** • **BMS Control** • **Software Parameter**

If you are experiencing any issues with the battery module or the BMS, please contact your distributor for assistance or troubleshooting steps.

Interface Menu Definition

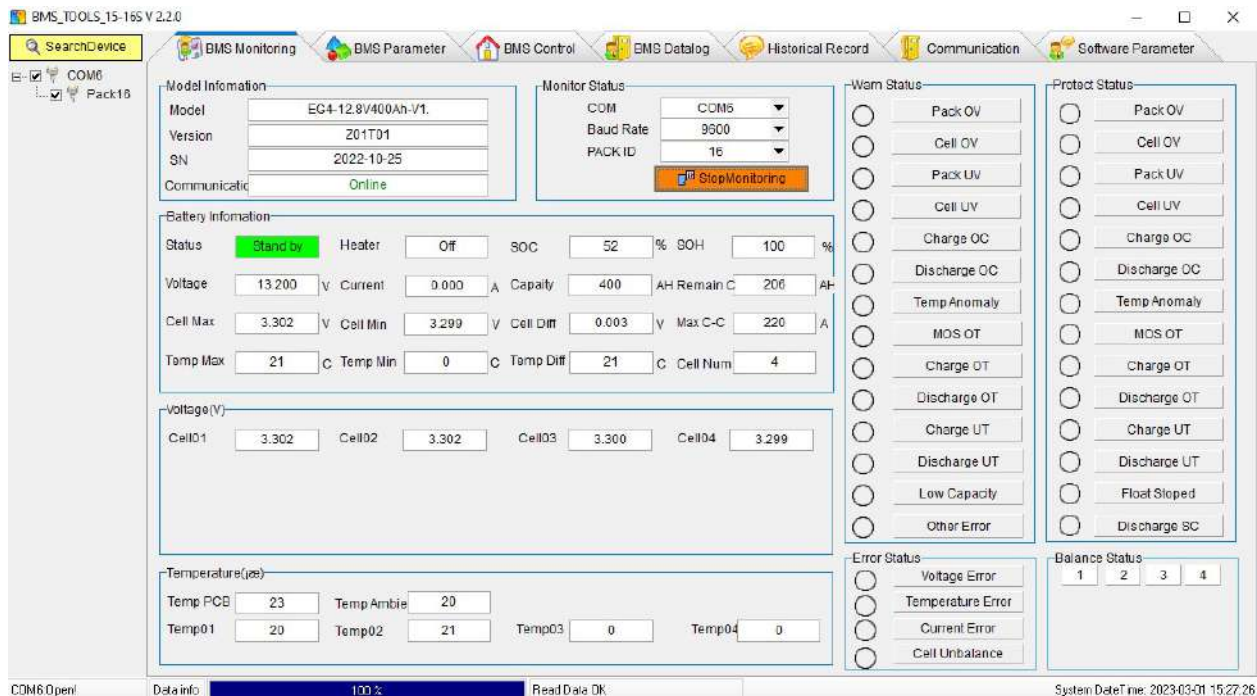

Item	Definition
BMS Monitoring	Real-time data and status monitoring of the BMS (see Section 12.3: Troubleshooting)
BMS Parameter	BMS parameter setting management (restricted, unauthorized changes will void warranty)
BMS Control	Control state management of BMS (restricted, unauthorized changes will void warranty)
BMS Datalog	BMS operation data logging to PC (for manufacturer use)
Historical Record	Real-time BMS operation data records (<i>exportable</i>)
Communication	Record of sending and receiving of battery pack data (<i>exportable</i>)
Software Parameter	Software configuration, settings, and language selection (restricted, unauthorized changes will void warranty)

11. Battery Charging

Charge cycle

Ensure the proper settings are set on the charge controller and/or inverter being used to avoid overcharging or damaging the module. (Refer to [Section 14.2: Technical Specifications Table](#) for a full list of charging/discharging parameters.)

Important (SOC Discrepancy)

It is normal for LFP batteries that have their own internal BMS and that are wired in parallel to demonstrate a wide variety of SOC readings during any given charge or discharge cycle. **Variations of up to 10% are common.** This is not cause for concern or indication that the module is providing less than the maximum capacity. This is caused by even slight variations in wiring resistance to each battery, internal resistance, temperature differences, and even variations in each cell. Even a slight variation causes one battery to take more of the load or charge for a short time. Over the duration of the discharge or charge cycle, this will balance out with the lagging battery then taking the load or charge at the other end of the cycle resulting in recovering the full listed KWH capacity of the pack. The voltage differences created as batteries diverge in SOC will eventually cause them to converge at some point in the cycle.

12. Troubleshooting, Maintenance & Disposal

12.1 Introduction to the BMS

The BMS (Battery Management System) is intended to safeguard the battery and battery cells against a variety of situations that could damage or destroy system components. This protection also aids in keeping the battery and battery cells operational for a greater number of life cycles. Each EG4® battery is specifically configured to ensure peak performance and operation with any system.

12.2 BMS Protection

PCB temperature protection

The BMS will ensure that the Printed Circuit Board (PCB) does not overheat. This is the part that houses most of the “brains” of the battery. This feature will turn off the battery if it begins to overheat.



Cell balance protection

Cell balance ensures that each cell is within a specific voltage range of each other. Cell balance is crucial for ensuring that the battery is operating properly for its lifespan. This is always done automatically.

Environmental temperature protection

It may be dangerous to attempt using the battery in extreme heat or cold. Continued operation in these conditions may result in permanent damage to the battery module and its components. To prevent this, the BMS is designed to measure the temperature while charging/discharging and will shut down the battery to prevent damage.

Voltage protection

The BMS is designed to continuously monitor the voltage of each individual cell and ensure that they are not over/undercharged.

Current protection

The BMS is designed to constantly monitor the charge/discharge amperage and has built-in safeguards against exceeding specific parameters. These include built-in timers that shut off quickly in the event of short circuits, extremely high amperage and delayed shut down for amperage that is only slightly above the maximum capacity.

12.3 Troubleshooting

Alarm Description and Troubleshooting

When the ALM light on the battery control panel is on, it means that the battery has given an alarm or has been protected from potential damage. Please check the cause of the failure through the app or BMS Tools and take appropriate measures or go directly to the battery site to troubleshoot.

BMS Tools alarms are shown in the table below:

Warning and protect status definitions

Status	Name	Definition	Action
Warning/ Protect	Pack OV	Pack over-voltage	Module needs to be discharged to lower its voltage.
	Cell OV	Cell over-voltage	Check individual cell voltage in BMS Tools.
	Pack UV	Pack under-voltage	Module needs to be charged.
	Cell UV	Cell under-voltage	Check individual cell voltage in BMS Tools.
	Charge OC	Charge over-current	Incoming current needs to be reduced.
	Discharge OC	Discharge over-current	Discharge current is too high; lower loads.
	Temp Anomaly	Temperature anomaly	Check ambient and module temperature.
	MOS OT	MOSFET over-temperature	BMS temperature is too high. Power off module and cool down location.
	Charge OT	Charge over-temperature	Power off module and cool down location.
	Discharge OT	Discharge over-temperature	Power off module and cool down location.
	Charge UT	Charge under-temperature	Power off module and warm up location.
	Discharge UT	Discharge under temperature	Power off module and warm up location.
Warning	Low Capacity	Low battery capacity	Module needs to be charged.
Warning	Other Error	Error not listed	Contact the distributor
Protect	Float Stopped	Float Stopped	Contact the distributor
Protect	Discharge SC	Discharge short circuit	Discharge current is too high, turn BMS and breaker off and back on to reset. Lower loads

Note: The “Historical Record” tab can indicate what occurred with the module before entering a warning or protection state. It is recommended to export this data into a text (.txt) file to provide to the distributor for any additional troubleshooting assistance.

Other common faults and solutions

Note: *If any of the warnings or faults from both tables persist, please contact the distributor for additional troubleshooting steps.*

Fault	Analysis	Action
Inverter communication failure	Check communication port connection, and battery ID setting.	Input proper “host” battery DIP switch address, and power cycle the battery.
No DC output	Open breaker, or battery voltage is too low.	Check battery breaker or charge the battery.
Power supply unstable	Battery capacity is not at full power.	Check for proper battery cable connection.
Battery cannot be charged fully	DC output voltage is below the minimum charge voltage.	Check the charging settings on the inverter to ensure they match battery requirements.
ALM LED always on	Short circuit	Disconnect the power cable and check all cables.
The battery output voltage is unstable.	Battery management system does not operate normally.	Press the reset button to reset the battery, then reboot the system.
ALM LED flashes 20 times with SOC1 LED on.	Unbalanced voltage within a cell	Deep discharge the battery bank (<20% SOC), then charge battery bank fully.
ALM LED flashes 20 times with SOC2 LED on.	Unbalanced temperature	Contact the distributor.
ALM LED flashes 20 times with SOC 3/4 LED on.	BMS damaged	Contact the distributor.
Different SOC value of batteries in parallel operation.	No issue	Deep discharge the battery bank (<20% SOC), then charge battery bank fully.
Low voltage protection with no LED on	BMS is in low voltage protection, and is in sleep mode	Contact the distributor.
Deeply discharged with “RUN” LED on	The battery voltage is too low to start BMS.	Contact the distributor.



12.4 Battery End of Life

The EG4® 48V battery is designed to last for *more than 15 years* when used correctly. We have worked tirelessly to ensure that our batteries will maintain a charge after thousands of cycles. However, when it does come time to retire the battery, there are a few things to consider.

Lithium iron phosphate batteries are considered a hazardous material and should not be disposed of by simply placing them in the trash. There are several websites and organizations that will accept this battery to recycle at little to no cost to the user. At EG4®, we understand that we are working with customers across the United States and the world. Our recommendation is to go online and search the term “Lithium Battery Disposal Near Me.” There will likely be an assortment of organizations that can safely dispose of LFP batteries. **We recommend calling ahead of time to ensure that the location is still open and accepting material.**

If, however, users are unable to locate a disposal location safely, EG4® is here to help. Before dumping the battery or disposing of it incorrectly, please contact our customer service team for assistance.

13. EG4® 10 Year Limited Warranty

The warranty must be registered within the first year of purchase to remain valid. If users choose not to register the product, the warranty may be invalidated. This limited warranty is to the original purchaser of the product and is not transferable to any other person or entity. All BMS and cell exchanges are covered throughout the warranty period. If a full replacement warranty is needed the warranty is prorated 1/9th per year after the first year at the current retail pricing. Please navigate to <https://eg4electronics.com/warranty-registration/> to register your warranty.

13.1 Warranty Exclusions

Under this limited warranty, EG4® Electronics has no obligation to the product if it is subject to the following conditions, including but not limited to:

- Damages incurred during installation or removal
- Damages caused during mishandling of product
- Inappropriate environmental exposure
- Damages caused by improper maintenance
- Unauthorized tampering, altering, and/or disassembly of product
- Using the product for purposes other than those intended by the manufacturer
- Lightning, Fire, Flood, or Acts of God
- Any product whose serial number has been altered, defaced, or removed

The equipment sold by EG4® Electronics is designed to be installed only by licensed, trained, and insured solar electrical installation professionals. We strongly advise customers to seek the assistance of such a professional to implement these products, and we make no warranty of the purchaser's safety, success of equipment implementation, or compliance with local codes and regulations.

EG4® Electronics disclaims all additional warranties, expressed or implied, including but not limited to, any implied warranty with respect to the accuracy or completeness of the information they disseminate and /or fitness of the materials sold for a particular purpose. No warranty may be created or extended by sales or promotional materials on these items. Each party hereby irrevocably waives its rights to trial by jury in any action or proceeding arising out of this agreement or the transactions relating to its subject matter. All installation advice provided by EG4® before, during, or after purchase of solar

equipment is purely for the purpose of general concept education and must not replace the expertise of a licensed and trained solar specialist. The customer agrees to full indemnification for EG4® henceforth from any legal recourse relating to and arising out of losses, direct or consequential, from the installation of the products purchased by the customer more than the value of the equipment purchase price.

14. Technical Specifications

14.1 Battery Performance Curves

Charge & Discharge curve with 0.5C @ 25°C

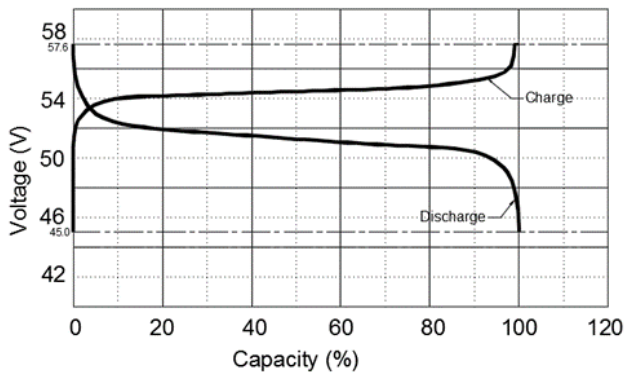

Discharge performance with different rate @ 25°C

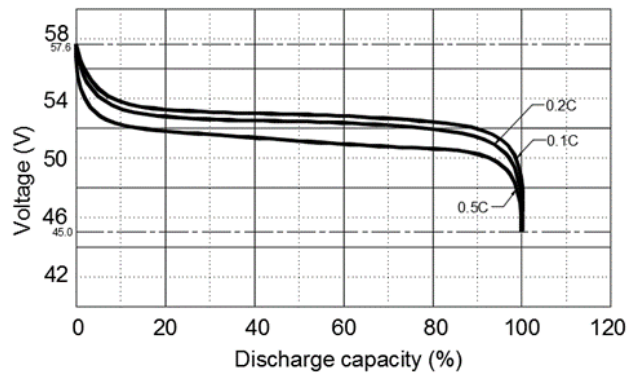

Discharge capacity with different temperature @ 0.5C

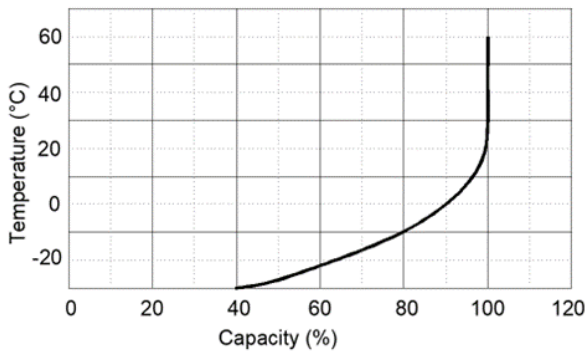

Cycle life with DOD @ 0.5C, 25°C

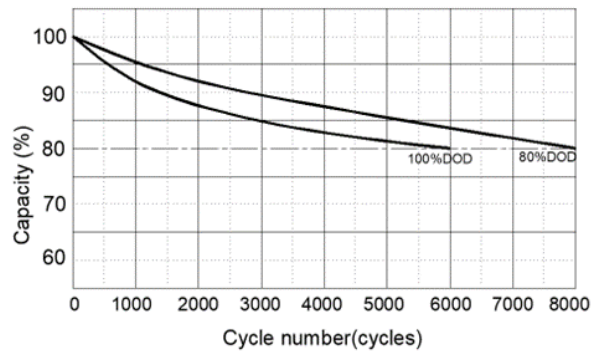

Self-discharge @ different temperature

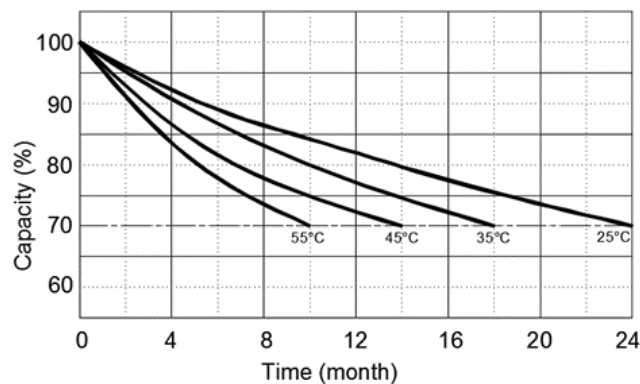



14.2 Technical Specifications Table

Module Operating Parameters			
Parameter	BMS		Recommended Setting
Voltage	51.2V		–
Capacity	280Ah		–
Charging Voltage (Bulk/Absorb)	56.0V (+/-0.8V)		56.2V (+/-0.2V)
Float	–		54V (+/-0.2V)
Low DC Cutoff	44.8V		47-45.6V (start high, lower as needed)
Charging Current	100/140/200A (Max. continuous)* <i>(see note below table)</i>		60A - 160A
Discharging Current	200A (Max. continuous)		160A
Environmental Parameters			
Charging Range	32° to ≈113°F (0°C to ≈45°C)		
Discharging Range	-4°F to ≈122°F (-20°C to ≈50°C)		
Storage Range	-4°F to ≈122°F (-20°C to ≈50°C)		
Ingress Protection	IP65		
Charging/ Discharging Parameters			
Charge	Spec	Delay	Recovery
Cell Voltage Protection	3.8V	1 sec	3.45V
Module Voltage Protection	60.0V	1 sec	55.2V
Over Charging Current 1	>205A	10 sec	–
Over Charging Current 2	>225A	3 sec	–
Temperature Protection	<23°F or >158°F <-5°C or >70°C	1 sec	>32°F or <140°F >0°C or <60°C
Discharge	Spec	Delay	Recovery
Cell Voltage Protection	2.3V	1 sec	3.1V
Module Voltage Protection	44.8V	1 sec	48V
Over-Charging Current 1	>205A	10 sec	60 sec
Over-Charging Current 2	>300A	3 sec	60 sec
Short Circuit	>600A	<0.1 mS	–
Temperature Protection	<-4°F or >167°F <-20°C or >75°C	1 sec	>14°F or <149°F >-10°C or <65°C
PCB Temp Protection	>230°F (>110°C)	1 sec	@ <176°F (<80°C)
General Specifications			
Parameter	Spec		Condition
Cell Balance	120mA	Passive Balance	Cell Voltage Difference >40mV
Temperature Accuracy	3%	Cycle Measurement	Measuring Range -40°F to ≈212°F (-40°C to ≈100°C)
Voltage Accuracy	0.5%	Cycle Measurement	For Cells & Module
Current Accuracy	3%	Cycle Measurement	Measuring Range -200A - 200A
SOC	5%	–	Integral Calculation
Power Consumption	Sleep & Off Mode	<300uA	Storage/Transport/Standby



Power Consumption	Operating Mode	<25mA	Charging/Discharging
Communication Ports	RS485/CAN		Can be customized
Battery Heater Specifications			
Parameter	Spec		Condition
Voltage	56V		-
Power Consumption	224W		-
Internal Battery Temperature	≤32°F (0°C)/≥41°F (5°C)		Heat On/Heat Off
Physical Specifications			
Dimensions (H×W×D)	34.6 in.×22.3 in.×9.1 in. (88.0 cm×56.6 cm×23.2 cm)		
Weight	308.6 lbs. (140 kg) +/-1kg		
Design Life	>15 Years		
Cycle Life	>8000 Cycles, 0.5C 80% DOD		
Lifetime Production	82.6MWh*		

*** $(51.2V \times 280Ah / 1000 \times 80\% \times 8000 \text{ cycles} / 1000) 90\% = MWh$**

Recommended Charge Current Settings for Paralleled Batteries on Paralleled 18kPVs

# of 18kPV Inverters	Recommended Max Inverter charge current available (230A per inv.)	1 Battery - Master Inv. Setting - Amps per battery (A)	2 Batteries - Master Inv. Setting - Amps per battery (A)	3 Batteries - Master Inv. Setting - Amps per battery (A)	4 Batteries - Master Inv. Setting - Amps per battery (A)
1	230 Amps	160 - 160	230 - 160	230 - 77	230 - 58
2	460 Amps	80 - 160	160 - 160	230 - 153	230 - 115
3	690 Amps	53 - 159	107 - 160	160 - 160	213 - 160

***Note:** The default BMS in the module allows for 100A charging current Maximum. To achieve higher charging currents, please contact your distributor for optional firmware files, or navigate to <https://eg4electronics.com/downloads/> for the most up to date firmware.

Please note that if the battery firmware is updated to allow 200A maximum charge, the internal thermal sensors will throttle the charge current to what the BMS deems necessary to prevent overheating.



15. Storage

Please follow these instructions for the safe storage of the unit to maintain the longevity of the battery, if you choose not to install the product immediately after purchasing or unpacking the box.

There are a few steps you can take to ensure that batteries are stored safely and in a state that will ensure they are not damaged during storage. The steps are detailed below.

Battery State

The state of the battery when placed into storage will affect how long it can be stored as well as the battery's condition when it is brought out of storage. EG4® recommends that each battery is brought to a 100% SOC (state of charge) before placing it in storage. Lithium iron phosphate batteries will lose a certain percentage of their total charge while in storage, depending on how long they are stored and the conditions they are stored in. We recommend recharging the batteries after 8–9 months in prolonged storage.

Environmental Factors

The environment you store your EG4® battery can greatly affect the health of the battery. **For best results**, the temperature should range between 33°F and 90°F (0.6°C and 32°C). Mount the battery in a location where it is not exposed to direct rain or standing water. Keep the battery **away from direct sunlight**. Store the batteries away from combustible materials.

Scan the QR code for
the most recent
version of the unit's
manual!



Scan the QR code for
the most recent
version of the unit's
spec sheet!





CONTACT US

Email: support@eg4electronics.com

Phone: +1 (903) 609-1988

Website: www.eg4electronics.com