

USER MANUAL



EG4 CHARGEVERTER 5KW AC CHARGER 100A 48VDC



ABOUT THIS MANUAL

Purpose

This manual describes the assembly, installation, operation and troubleshooting of this unit. Please read this manual carefully before installation and operation.

Scope

This manual provides safety and installation guidelines as well as information on tools and wiring.

SAFETY INSTRUCTIONS



WARNING: This section contains important safety and operating instructions. Read and keep this manual for future reference.

1. Before using the unit, read all instructions and cautionary markings on the unit, the batteries and all appropriate sections of this manual.
2. **CAUTION - This charger is set up to charge LiFePO4 batteries. Other battery chemistries are supported. However, verify with the battery manufacturer for charging specifications prior to use, otherwise battery damage and/or bodily harm can occur.**
3. Do not disassemble the unit. When service or repair is required, take it to a qualified service center. Incorrect re-assembly may result in a risk of electric shock or fire.
4. To reduce risk of electric shock, disconnect all wiring before attempting any maintenance or cleaning. Turning off the unit will not reduce this risk.
5. **CAUTION - Use extreme care when attaching this device to a battery.**
6. **NEVER** charge a frozen battery.
7. Be very cautious when working with metal tools on or around batteries. A potential risk exists for a dropped tool to spark or short circuit batteries or other electrical parts causing a fire.
8. Please strictly follow installation procedure when connecting or disconnecting DC terminals. Please refer to installation section of this manual for details.
9. Breaker is required as overcurrent protection for the power supply.
10. **GROUNDING INSTRUCTIONS** -This charger should be connected to a permanent grounded wiring system. Be sure to comply with local requirements and regulation when using this charger.
11. **NEVER** short DC inputs.
12. **Warning!!** *Only qualified personnel are able to service this device. Please contact the tech department of the distributor where you purchased your product for assistance with any issues.*

DISCLAIMER

EG4 reserves the right to make changes to the material herein at any time without notice. You may refer to the EG4 website at www.eg4electronics.com for the most updated version of our manual.

PRODUCT OVERVIEW

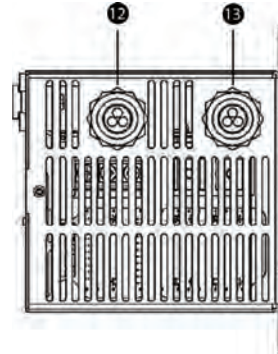
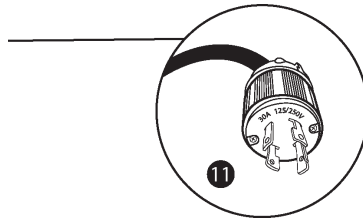
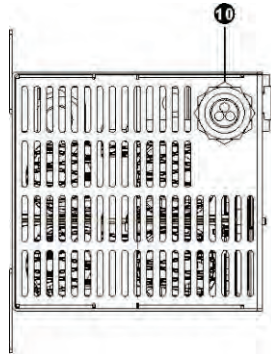
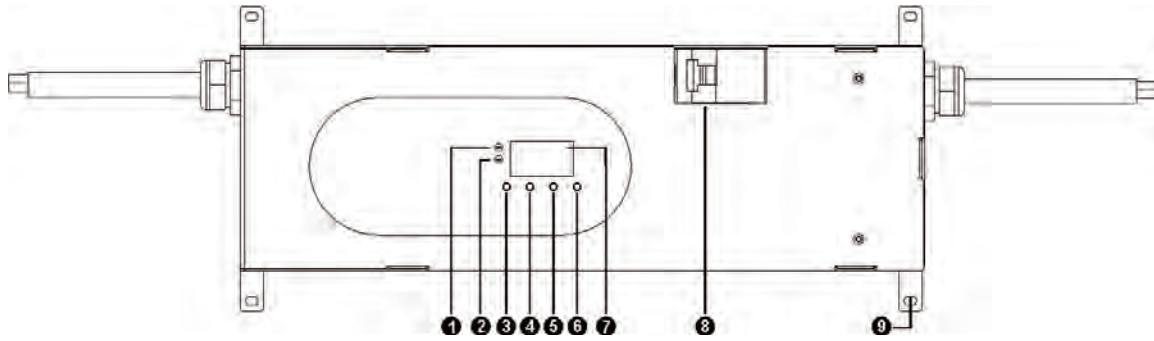

1. Power indicator
2. Charging indicator
3. Function button - ESC
4. Function button - UP
5. Function button - DOWN
6. Function button - ENTER
7. LCD display
8. Battery breaker
9. Holding bracket
10. AC line input
11. Prewired 250V, 30A, twist-lock plug
11a. Plug pinout
12. Positive battery cable input
13. Negative battery cable input

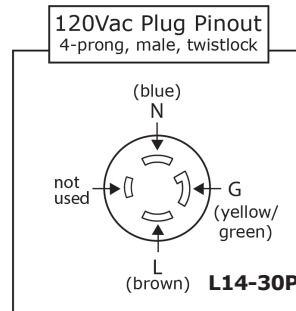
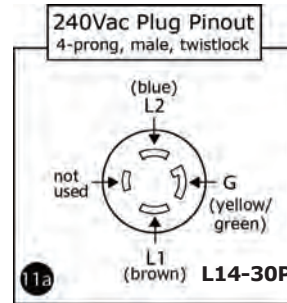

Other Common 30A 120V Plug Pinouts

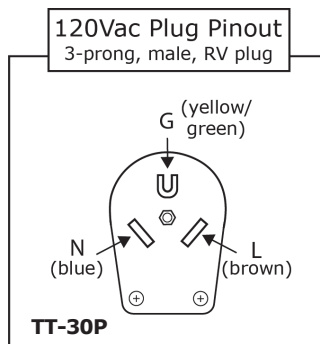
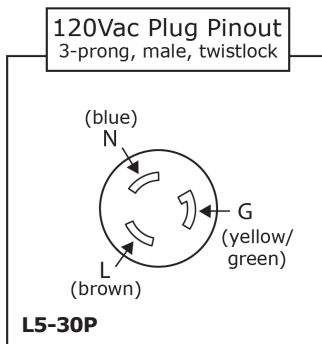

Warning!! Plug pinouts are provided as an example. Please seek guidance from a qualified professional before making any modifications.

INSTALLATION

Unpacking and Inspection

Before installation, please inspect the unit. Be sure that nothing inside the package is damaged. You should have received the following items inside of the package:

1. The unit × 1
2. User manual × 1
3. Screws × 4

Mounting the Unit

Consider the following points before selecting where to install:

1. Do not mount the charger on flammable construction materials.
2. Suitable for mounting on concrete or other non-combustible surface only.
3. Install this charger at eye level or a location that allows the LCD screen to be easily viewed.
4. The ambient temperature should be between 0°C and 55°C to ensure optimal operation.
5. The recommended installation position is to be attached to the wall.
6. Verify there is sufficient room for heat dissipation and space for wires.

 **Chargeverter can produce heat of more than 131°F (55°C). It is recommended to mount this unit on appropriate backing, such as cement board, with sufficient clearance around the unit to allow proper airflow. Do not block the air vents**

Install the unit by securing with four M4 screws.

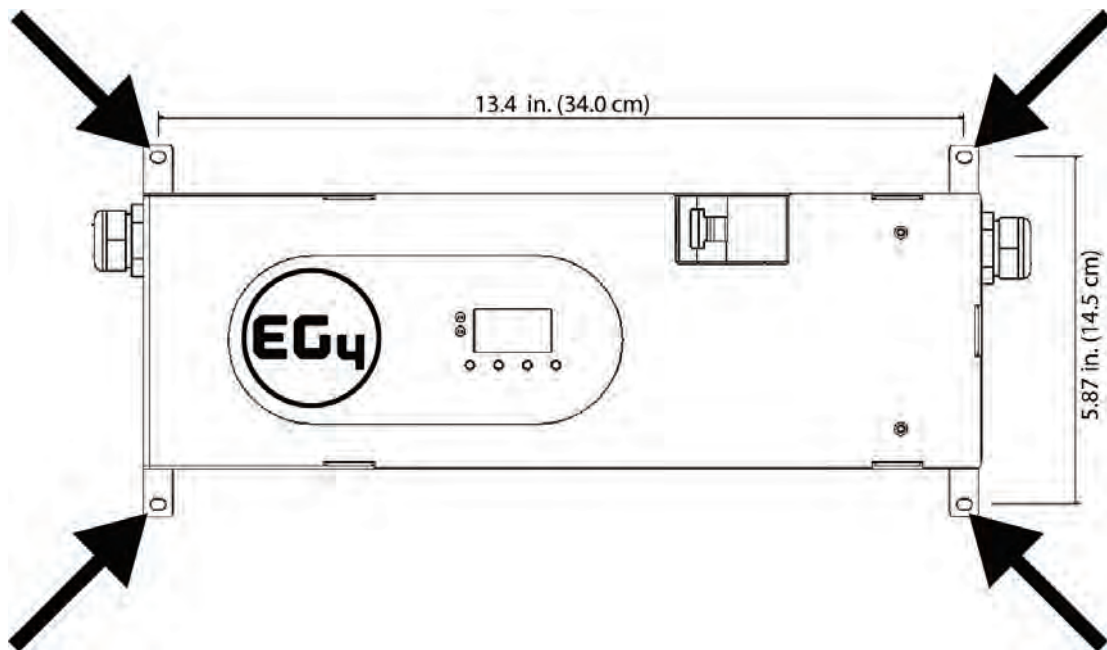

Warning: Ensure battery breakers and/or battery on/off switches are in the off position and the charger is not plugged in while installing battery charging cables.

AC and DC Connections

- Connect battery cables to the battery terminals or bus bars using appropriate size bolts.
- Ensure charger cable ring terminals are attached to the battery terminals/bus bar of the proper polarity and tightened to the proper torque specifications.
- For 240V usage, plug the charger into a 250V 30A twist lock receptacle with a dedicated 30A breaker.
- For 120V usage, plug the charger into a 125V 30A receptacle with a dedicated 30A breaker.

Note: Please see plug pinouts for popular available plug types on page 2, showing 240V to 120V plug conversion examples.

OPERATION

Power ON/OFF

1. Ensure that the battery cables are securely connected.
2. Plug the charger into an outlet of the proper voltage and amperage.
3. Turn on battery breakers and/or battery on/off switches.
4. Turn on the built-in battery breaker on the front of the unit.
5. The unit will begin charging and work normally if properly connected.

Operation and Display Panel

The operation and display panel, shown in the chart below, is located on the front panel of the AC charger. It includes two indicators, four function keys and an LCD display, indicating the operating status and input/output power information of the unit.

LED Indicator

LED Indicator			Messages
POWER	Green	Solid On	The unit is powered on
CHG	Green	Solid On	Battery is fully charged.
		Flashing	Battery is charging.

Function Keys

Function Key	Description
ESC	To exit setting mode
UP	To go to previous selection
DOWN	To go to next selection
ENTER	To confirm the selection in setting mode or enter setting mode

LCD Setting

Press the "ENTER" button on the front of the unit to enter the settings mode. Press "UP" or "DOWN" button to select setting programs. Press "ENTER" button to confirm the selection or "ESC" button to exit.

Setting Programs:

Program	Description	Selectable option
Program 1	Charging voltage	Setting range is from 43V to 57V
Program 2	Charging current	Setting range is from 0A to 100A*

**Recommended 30A charging rate per battery to maintain battery lifespan and 85A total charging rate to reduce heat output of the unit.*

SPECIFICATIONS

Charger Output Specifications	
Battery Voltage	48Vdc nominal
Charge Current (adjustable)	0-100A (50A at 120V)
Charge Voltage (adjustable)	43-57dc (default 54Vdc)
Max Output Watts	5120W at 240Vac, 3050W at 120Vac
Max Efficiency	94% at 240Vac, 92% at 120Vac
AC Input Specifications	
AC Input Voltage Range	90-264Vac
AC Frequency	50-60Hz
Maximum Input Amps	26A at 240Vac, 28A at 120Vac
Environmental Specifications	
Operating Temperature Range	14°F to 131°F (-10°C to 55°C)
Humidity	5% to 95% relative humidity (non-condensing)
Rating	IP21
Operating Altitude	0~1500 m (0~4921 ft.)
General Specifications	
Dimensions H×W×D	4.5×13.8×4.7 in. (11.5×35.0×12.0 cm)
Net Weight	16.4 lbs. (7.4 kg)
Warranty	3 years (only when used indoors)