

# USER MANUAL

EG4 6500 EX-48  
SOLAR INVERTER/CHARGER  
6.5KVA 120V AC



# Table of Contents

## About This Manual

- Purpose & Scope ..... 3
- Safety Notice ..... 3

## Introduction

- Features ..... 4
- Basic System Architecture ..... 4
- Product Overview ..... 5
- Specifications ..... 6
- Dry Contact Relay ..... 9

## Preparation & Installation

- Unpacking and Inspection ..... 10
- Mounting the Inverter ..... 11
- Battery Connection ..... 12
- BMS Communications ..... 13
- EG4 Battery Communications and Configuration ..... 14
  - AC Input and Output Connections ..... 17
  - PV Connections ..... 19
- Parallel Inverter Connections ..... 20
- Remote Display ..... 27
- Final Assembly ..... 27

## Operating the Inverter/Charger

- Powering On/Off ..... 29
- Display Panel ..... 29
- Operating Modes ..... 37
- System Settings ..... 40
- USB Function Settings ..... 51

## Commissioning

- Single Phase 120V ..... 54
- Split-Phase 240V ..... 55
- Three Phase ..... 56

## Maintenance & Troubleshooting

- Cleaning and Care ..... 58
- Troubleshooting Tables ..... 59

## Appendix I

- Fault Code Table ..... 61
- Warning Code Table ..... 63
- Lead Battery Chemistry Equalization ..... 64

## Appendix II

- Wifi Operation Guide ..... 65

## Appendix III

- UL Documentation ..... 74

## ABOUT THIS MANUAL

### Purpose

This manual describes installation, commissioning, operation, and troubleshooting. Please read the manual fully and carefully before installing and operating. Keep this manual for future use.

### Scope

This manual provides basic safety and installation guidelines as well as information on tools and wiring.

## SAFETY NOTICE

**⚠ ATTENTION: The following contains important safety and operating instructions. Read and keep this manual for future reference.**

1. Before installing or using the unit, read all instructions and cautionary markings on the unit, the batteries, and all appropriate sections of the manual.
2. **CAUTION-** Do not disassemble the unit. Take it to a qualified service center when service or repair is required. Incorrect re-assembly may result in a risk of electric shock or fire.
3. To reduce risk of electric shock, shutdown and disconnect all wirings before attempting any maintenance or cleaning. Turning off the unit alone will not reduce the risk of shock or injury.
4. **CAUTION** – Only qualified personnel can install this equipment.
5. **NEVER** charge a battery below specified minimum temperature; refer to the battery data sheet.
6. Wire size is critical for safe operation, and optimal performance of the equipment. Refer to a accredited sizing resource or cable manufacturer specifications to meet inverter/charge requirements.
7. Use caution when working with metal tools on or around all systems and batteries. Risk of electrical arcs and/or short circuiting of equipment can lead to severe injury and damage.
8. Strictly follow installation procedure when connecting and disconnecting AC or DC terminals. Refer to INSTALLATION section of the manual for details.
9. Size and install the correct over current protection device(s) between batteries and inverters.
10. **GROUNDING** -This inverter/charger should be connected to a permanent grounded wiring system. The grounding system must meet the Authority Having Jurisdiction (AHJ) requirements in your area.
11. **NEVER** short AC output and DC inputs. Do NOT connect to the grid with a shorted DC input.
12. **Warning!!** Only qualified service persons are able to service this device. If errors still persist after following troubleshooting table, please contact your retailer for further assistance.
13. **WARNING:** Because this inverter is non-isolated, only three types of PV modules are acceptable: Mono-crystalline, Polycrystalline with class A-rated, and CIGS modules. To avoid any malfunction, do not connect any PV modules with possible current leakage to the inverter. For example, grounded PV modules will cause current leakage to the inverter. When using CIGS modules, please be sure NOT to ground.
14. **CAUTION:** DC breakers and surge protection on PV lines is recommended. Without breakers the equipment is at higher risk of damage from sources such as surges and lightning strikes.

## **DISCLAIMER**

EG4 reserves the right to make changes to the material herein at any time without notice. You may refer to the EG4 website at [www.eg4electronics.com](http://www.eg4electronics.com) for the most updated version of our manual.

## INTRODUCTION

This is a residential self consumption multi-function inverter, combining the functions of an inverter, solar controller, and battery charger to offer uninterrupted power support in a single package. The comprehensive LCD display offers user-configurable and easily-accessible button operations such as battery charging current, AC or solar charging priority, and acceptable input voltage based on different applications.

## Features

- Configurable color with the built-in RGB LED bar
- Built-in Wi-Fi for mobile monitoring (APP is required)
- Supports USB On-the-Go function to easily upgrade firmware
- Built-in anti-dust kit
- Detachable LCD control module with multiple communication ports for BMS (RS485, CAN-BUS, RS232)
- Configurable input voltage tolerances for home appliances and personal computers via LCD control panel
- Configurable AC/PV output usage timer and prioritization
- Configurable AC/Solar charger priority via LCD control panel
- Configurable battery charging current based on applications via LCD control panel
- Compatible with the grid or generator power
- Auto restart on AC reconnect
- Overload / Over temperature / short circuit protection
- Smart battery charger design for optimized battery performance

## Basic System Architecture

The following illustration is an example of a basic application for this unit showing multiple inputs and outputs. Please note an AC source may not be required for operation and is listed as an example only:

- Generator or Utility
- 48V Battery
- PV modules

Consult with a system installer and/or designer for other possible system design options depending on the specific site requirements. System design is key to proper function and performance and sites and systems vary greatly.

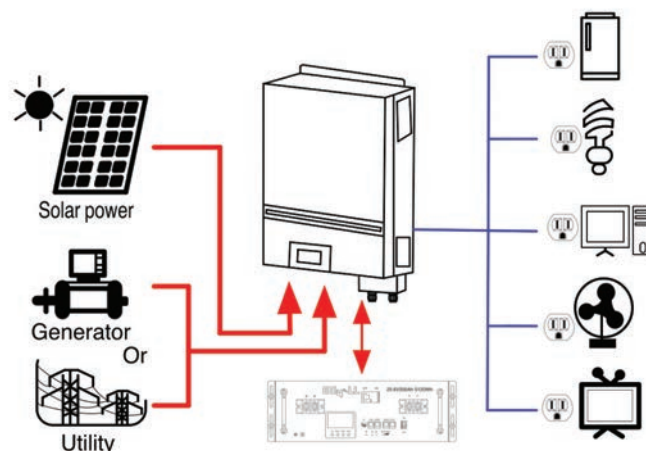

**Figure 1 Basic PV System Overview**



### Product Overview

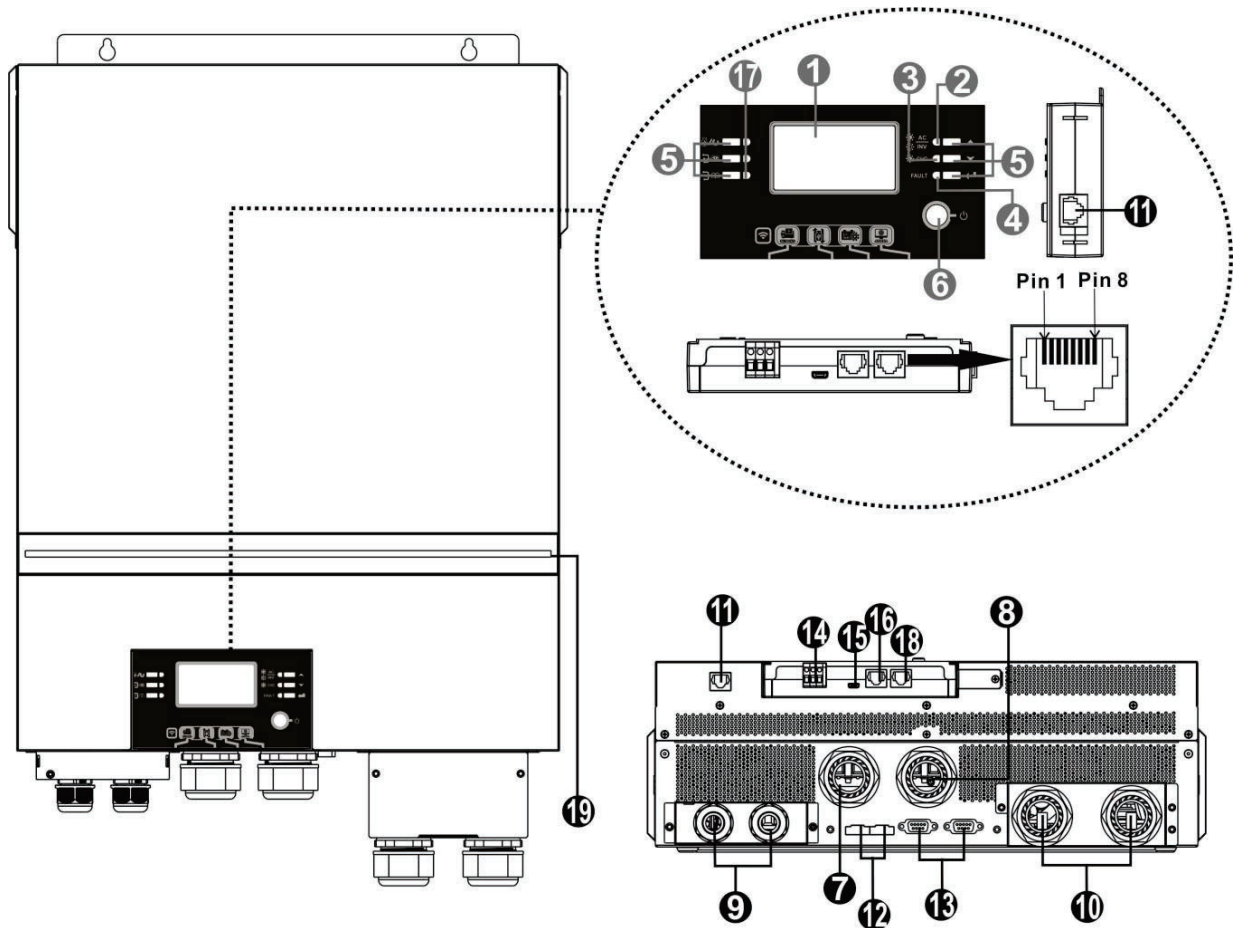

**Installation Note:** The EG4 6.5KW unit is a parallel capable model. For parallel 120V, 240V Split-phase, or 3-phase installation diagrams and instructions, please check the *Parallel Connections* and *Commissioning* sections of the manual for further details.

- |  |  |
|--|--|
| <ul style="list-style-type: none"> <li>1. LCD display</li> <li>2. Status indicator</li> <li>3. Charging indicator</li> <li>4. Fault indicator</li> <li>5. Function buttons</li> <li>6. Power on/off switch</li> <li>7. AC input connectors</li> <li>8. AC output connectors (Load connection)</li> <li>9. PV terminal</li> <li>10. Battery connectors</li> <li>11. Remote LCD module communication Port</li> </ul> | <ul style="list-style-type: none"> <li>12. Current sharing port</li> <li>13. Parallel communication port</li> <li>14. Dry contact</li> <li>15. OTG-USB port as USB communication port and USB function port</li> <li>16. BMS communication port: CAN, RS-485 or RS-232</li> <li>17. Output source indicators (refer to OPERATION/Operation and Display Panel section for details) and USB function setting reminder (refer to OPERATION/Function Setting for the details)</li> <li>18. RS-232 communication port for firmware updates from a PC</li> <li>19. RGB LED bar (refer to LCD Setting section for the details)</li> </ul> |
|--|--|

## SPECIFICATIONS

Table 1 Line Mode Specifications

MODEL	6.5KW
<b>Input Voltage Waveform</b>	Sinusoidal (utility or generator)
<b>Nominal Input Voltage</b>	120Vac
<b>Low Loss Voltage</b>	90Vac±7V (UPS) 80Vac±7V (Appliances)
<b>Low Loss Return Voltage</b>	100Vac±7V (UPS); 90Vac±7V (Appliances)
<b>High Loss Voltage</b>	140Vac±7V
<b>High Loss Return Voltage</b>	135Vac±7V
<b>Max AC Input Voltage</b>	150Vac
<b>Max AC Input Current</b>	60A
<b>Nominal Input Frequency</b>	50Hz / 60Hz (Auto detection)
<b>Low Loss Frequency</b>	40±1Hz
<b>Low Loss Return Frequency</b>	42±1Hz
<b>High Loss Frequency</b>	65±1Hz
<b>High Loss Return Frequency</b>	63±1Hz
<b>Output Short Circuit Protection</b>	Line mode: Circuit Breaker (60A) Battery mode: Electronic Circuits
<b>Efficiency (Line Mode)</b>	>95% ( Rated R load, battery full charged )
<b>Transfer Time</b>	10ms typical (UPS); 20ms typical (Appliances)
<b>Power Limitation</b>	

Table 2 Inverter Mode Specifications

<b>MODEL</b>	<b>6.5KW</b>
<b>Rated Output Power</b>	6,500W
<b>Output Voltage Waveform</b>	Pure Sine Wave <3% THD
<b>Output Voltage Regulation</b>	120Vac±5%
<b>Output Frequency</b>	60Hz or 50Hz
<b>Peak Efficiency</b>	91%
<b>Overload Protection</b>	100ms@≥205% load;5s@≥150% load; 10s@110%~150% load
<b>Surge Capacity</b>	13,000W
<b>Nominal DC Input Voltage</b>	48.0Vdc
<b>Cold Start Voltage</b>	46.0Vdc
<b>Low DC Warning Voltage</b>	
@ load < 20%	46.0Vdc
@ 20% ≤ load < 50%	42.8Vdc
@ load ≥ 50%	40.4Vdc
<b>Low DC Warning Return Voltage</b>	
@ load < 20%	48.0Vdc
@ 20% ≤ load < 50%	44.8Vdc
@ load ≥ 50%	42.4Vdc
<b>Low DC Cut-off Voltage</b>	
@ load < 20%	44.0Vdc
@ 20% ≤ load < 50%	40.8Vdc
@ load ≥ 50%	38.4Vdc
	64.0Vdc
<b>High DC Cut-off Voltage</b>	66.0Vdc
<b>DC Voltage Accuracy</b>	+/-0.3V@ no load
<b>THDV</b>	<5% for linear load,<10% for non-linear load @ nominal voltage
<b>DC Offset</b>	≤100mV

Table 3 Charge Mode Specifications

Utility Charging Mode		
<b>MODEL</b>	<b>6.5KW</b>	
<b>Charging Current (UPS)</b> @ Nominal Input Voltage	120A	
<b>Bulk Charging Voltage</b>	<b>Flooded Battery</b>	58.4Vdc
	<b>AGM / Gel Battery</b>	56.4Vdc
<b>Floating Charging Voltage</b>	54.0Vdc	
<b>Overcharge Protection</b>	66.0Vdc	
<b>Charging Algorithm</b>	3-Step	
<b>Charging Curve</b>	<p>The graph plots Battery Voltage (per cell) on the left y-axis and Charging Current (%) on the right y-axis against Time on the x-axis. The voltage curve (black line) starts at 2.25Vdc, rises linearly to 2.43Vdc (2.35Vdc) during the Bulk phase (T0), remains constant during the Absorption phase (T1), and then slightly drops during the Maintenance phase. The current curve (red line) is constant at 100% during the Bulk phase, then decreases during the Absorption phase, and continues to decrease during the Maintenance phase. T1 is specified as a minimum of 10 minutes and a maximum of 8 hours.</p>	
Solar Input		
<b>MODEL</b>	<b>6.5KW</b>	
<b>Rated PV</b>	8000W	
<b>Max. PV Array Open Circuit Voltage</b>	500Vdc	
<b>PV Array MPPT Voltage Range</b>	90Vdc~450Vdc	
<b>Max. Input Current Draw</b>	18A x 2	
<b>Start-up Voltage</b>	80V +/- 5Vdc	
<b>Power Limitation</b>	<p>The graph plots PV Current on the y-axis against MPPT temperature on the x-axis. The current is constant at 18A from 0°C to 75°C. At 75°C, the current drops to 9A and remains constant until 85°C. Above 85°C, the current is not shown, indicating a further reduction or shutdown.</p>	

Table 4 General Specifications

<b>MODEL</b>	<b>6.5KW</b>
<b>Safety Certification</b>	UL 1741 by TUV
<b>Operating Temperature Range</b>	-10°C to 40°C
<b>Storage temperature</b>	-15°C~ 60°C
<b>Humidity</b>	5% to 95% Relative Humidity (Non-condensing)
<b>Dimension (D*W*H), in</b>	5.80in x 17.02in x 22.66in (24.43in) (with extension box)
<b>Net Weight, lbs</b>	40.5lbs

Table 5 Parallel Specifications (Parallel model only)

<b>Max parallel numbers</b>	6
<b>Circulation Current under No Load Condition</b>	Max 2A
<b>Power Unbalance Ratio</b>	<5% @ 100% Load
<b>Parallel communication</b>	CAN
<b>Transfer time in parallel mode</b>	Max 50ms
<b>Parallel Kit</b>	YES

*Note: Parallel feature will be disabled when only PV power is available*

## Dry Contact Relay

There is one dry contact (3A/250VAC) available on the bottom of the inverter display. It can be used to deliver signal to external device when battery voltage reaches a set warning level.

Unit Status	Condition		Dry contact port: 		
			NC & C	NO & C	
Power Off	Unit is off and no output is powered.		Close	Open	
Power On	Output is powered from Battery power or Solar energy.	Program 01 set as USB (utility first) or SUB (solar first)	Battery voltage < Low DC warning voltage	Open	Close
			Battery voltage > Setting value in Program 13 or battery charging reaches floating stage	Close	Open
		Program 01 is set as SBU (SBU priority)	Battery voltage < Setting value in Program 12	Open	Close
			Battery voltage > Setting value in Program 13 or battery charging reaches floating stage	Close	Open

## PREPERATION & INSTALLATION:

### Unpacking and Inspection

Before installation, please inspect the unit. Be sure that nothing inside the package is damaged. The following items should be included in the package:

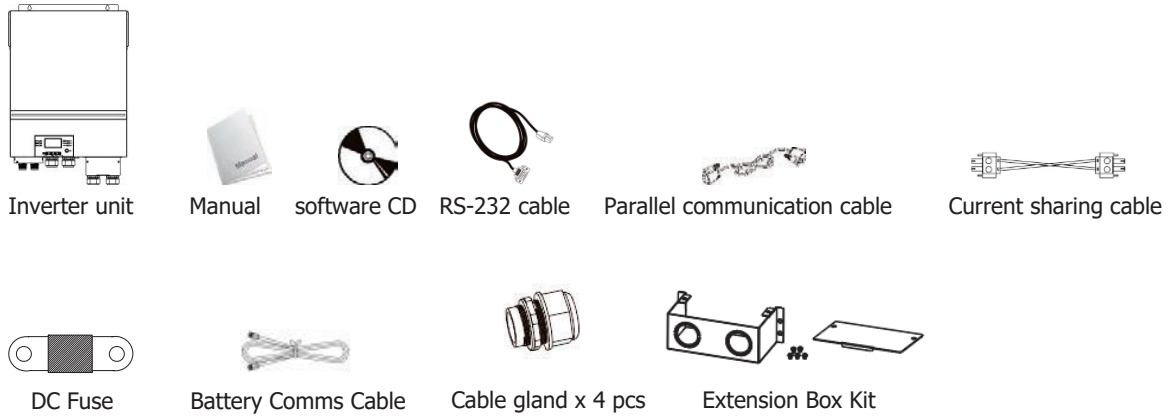

### Installation of Battery Wiring Extension Box, Cable Glands, and Conduit Fittings 1/2" or 3/4"

Install two (2) cable glands or conduit fittings on the extension box, then fix the extension box on the rear panel of the inverter. *Note: Installation of the battery wiring extension box is necessary for UL conformity. If UL conformity is not required in your region, it is sufficient to only install the cable glands (Fig.2) shown below.*

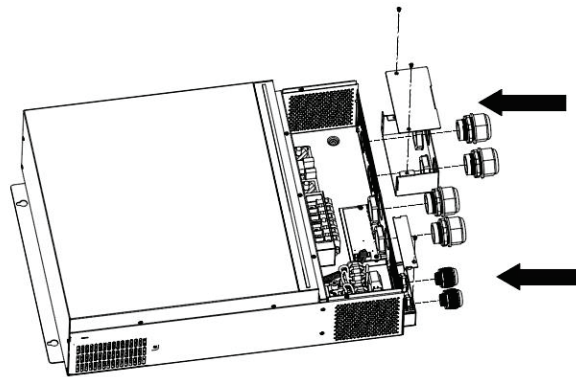

Fig.1 6500 with Extension Box

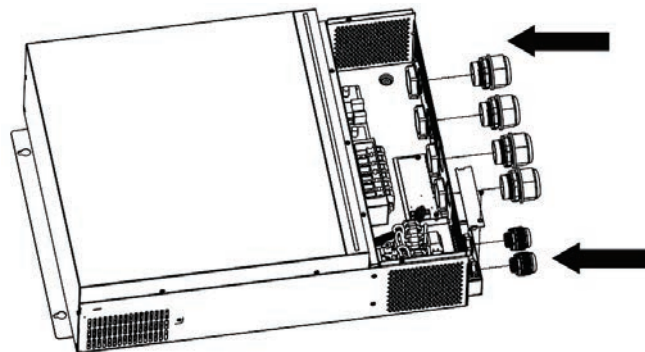
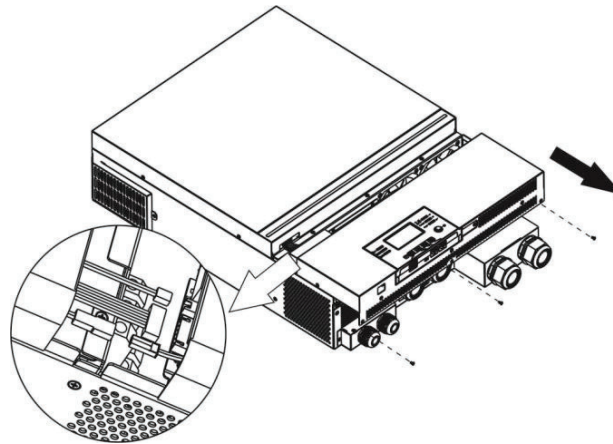

Fig.2 6500 without Extension Box

Before connecting all wirings, please take off bottom cover by removing the five screws. When removing the bottom cover, be carefully to remove three cables as shown below.



### Mounting the Inverter

Consider the following points before selecting an install location:

- Do not mount the inverter on flammable materials.
- Mount on a solid surface.
- For optimal operation, install in a location where ambient temperature stays between 0°C - 40°C (32°F - 104°F).
- Mount the unit in a vertical position and following the clearance guide for proper cooling and longevity.
- Follow clearance guidelines shown to the right diagram to guarantee sufficient heat dissipation and clearance for conduit and wire runs.
- Ensure mounting location follow your local authority having jurisdiction rules on working space requirements. For the US market, refer to the NEC version adopted by your AHJ.

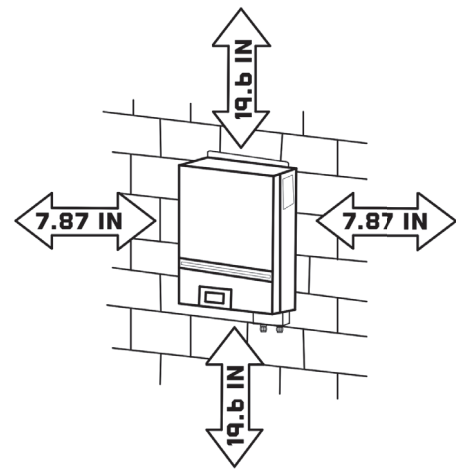

**⚠ SUITABLE FOR MOUNTING ON CONCRETE OR OTHER NON-COMBUSTIBLE SURFACE ONLY.**

Mount the unit using the 4 holes denoted below. M5 (#10 Imperial) screw/bolt diameter is recommended.

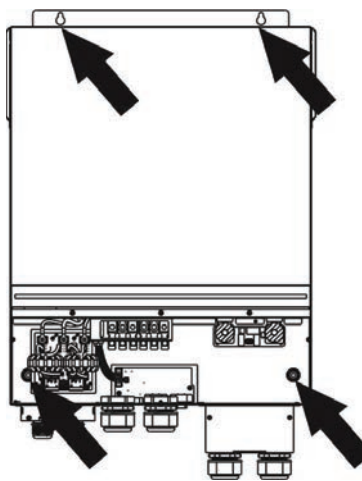

## Battery Connection

**CAUTION:** For safe operation and regulation compliance, DC overcurrent protection and means of disconnect should be installed between the battery and inverter. In many cases individual battery units will come with breakers, however overcurrent and disconnecting means should be added for banks of multiple batteries. Please refer to the typical amperage in table below for required fuse or breaker size.

**WARNING!** All wiring design and install must be performed by qualified personnel.

**WARNING!** For safe and efficient operation use the appropriate cable size for battery connections. To reduce risk of injury and equipment damage, use properly rated cable and terminal sizes.

Ring terminal:

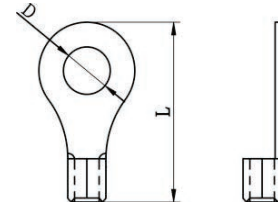

Recommended battery cable and terminal size:

Model	Typical Amperage	Battery capacity	Minimum Wire Size	Cable mm <sup>2</sup>	Ring Terminal Dimensions		Torque value
					D (mm)	L (mm)	
6.5KW	153A	300AH	≥1/0AWG	67	8.4	47	5 Nm

Please follow the below steps for battery connection:

1. Insert the ring connection end of the battery cable through the cable gland of the inverter.
2. Ensure the bottom (flat) side of the cable ring termination is fully seated on the inverter battery terminals.
3. Tighten the terminal nuts to a torque of 5 Nm (3.6ft lbs). Make sure polarity at both the battery and the inverter/charge is correctly connected and ring terminals are tightly screwed to the battery terminals.

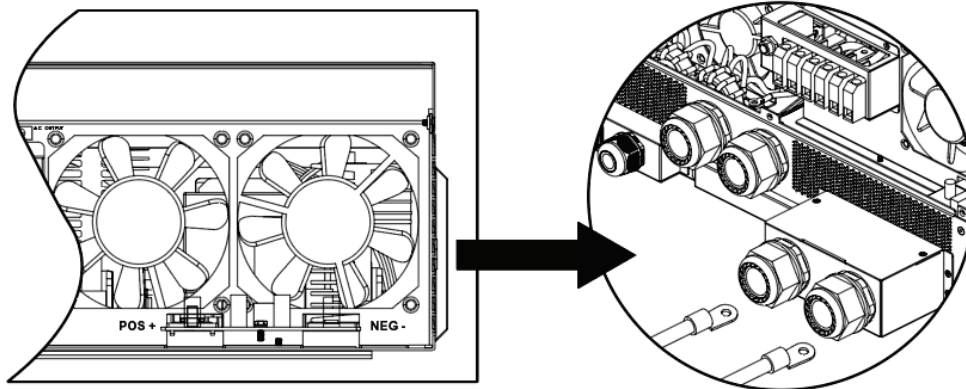

**WARNING: Shock Hazard**

Arc and shock hazards are present! Do not touch uninsulated wires, and use caution when making connections. Ensure all equipment is turned off, use proper safety equipment, and follow best practices.



**CAUTION!!** Do not place anything between the inverter terminal and the battery cable ring connector. Overheating and equipment damage can occur.

**CAUTION!!** Do not apply anti-oxidant substance on the terminals.

**CAUTION!!** Before making the final DC connection or powering on DC circuits ensure both positive and negative cable runs are correctly connected throughout the system. Incorrect or loose connections will damage equipment and pose electrical shock, arc, and fire risks.



## AC Input/Output Connections

**CAUTION!!** Install a breaker at the source of the AC input power source per requirements of authority having jurisdiction. Ensure the AC source circuit is properly rated for the inverter/charger load specification.

**CAUTION!!** There are two terminal blocks with "IN" and "OUT" markings. Do NOT reverse the input and output connections. Ensure Line, Neutral, and Ground are wired to the correct terminals.

**WARNING!** All wiring must be performed by a qualified personnel.

**WARNING!** It is very important for system safety and efficient operation to use appropriate cable for AC input connection. To reduce risk of injury and equipment damage, use properly sized cables according to local jurisdiction and electrical code/requirements.

### Suggested cable requirement for AC wires

Model	Gauge	Torque Value
6.5KW	6 - 4 AWG Max	1.4~ 1.6Nm

Follow the below steps to connect the AC input and output:

1. Before making AC input/output connection, be all power sources are off.
2. Remove 10mm (3/8in) wire insulation from the ground wires. Remove 7mm (~1/4in) of wire insulation from the Line and Neutral conductors. Ensure no conductor is exposed beyond terminal block, paying special attention to possible stray wire strands.
3. Fix two cable glands into input and output sides.
4. Insert AC input wires according to polarities indicated on terminal block and tighten the terminal screws. Be sure to connect the ground (PE) conductor (⊕) first.

⊕ **Ground (Green or Green with Yellow stripe)**  
 L→**LINE(Black for Line 1)(Red for Line 2 in 120/240 split-phase configuration)**  
 N→**Neutral (White or Gray)**    **NOTE:** Wire colors may vary.

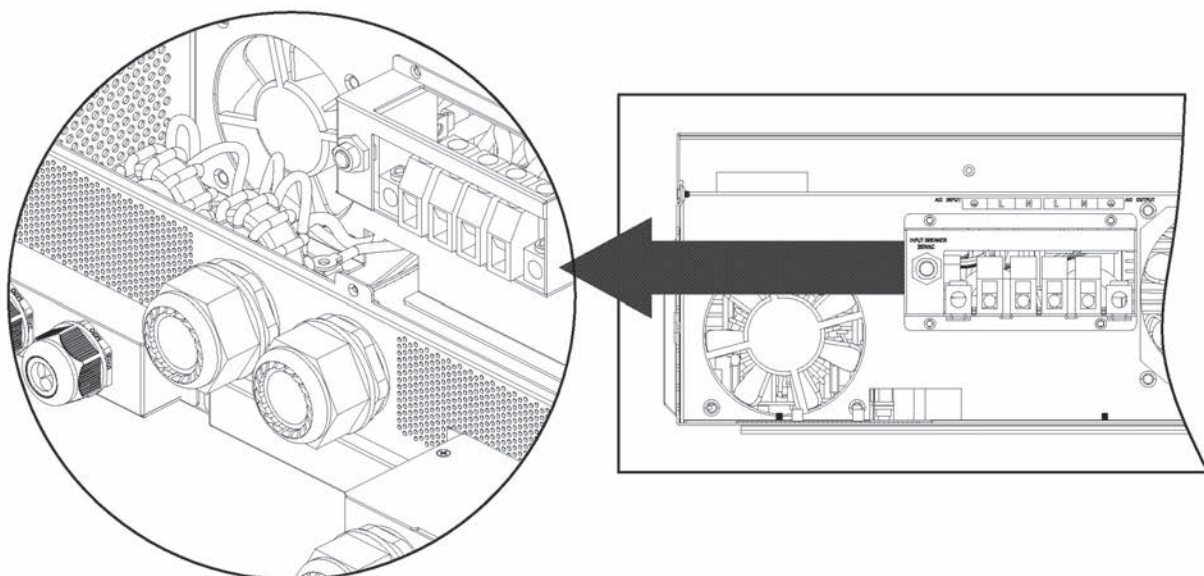

**WARNING:**

Ensure all AC sources remain off and all loads are turned off at the breakers before continuing with the wiring process. Confirm AC source is off with multi-meter or non-contact voltage pen/tester.

5. Connect the AC output wires according to labels printed on the case above the terminal blocks.

Connect the ground (PE) conductor first (⊕).

⊕ **Ground (Green or Green with Yellow stripe)**

**L**→**LINE (Black for Line 1)(Red for Line 2 in 120/240 split-phase configuration)**

**N**→**Neutral (White or Gray)** **NOTE:** Wire colors may vary.

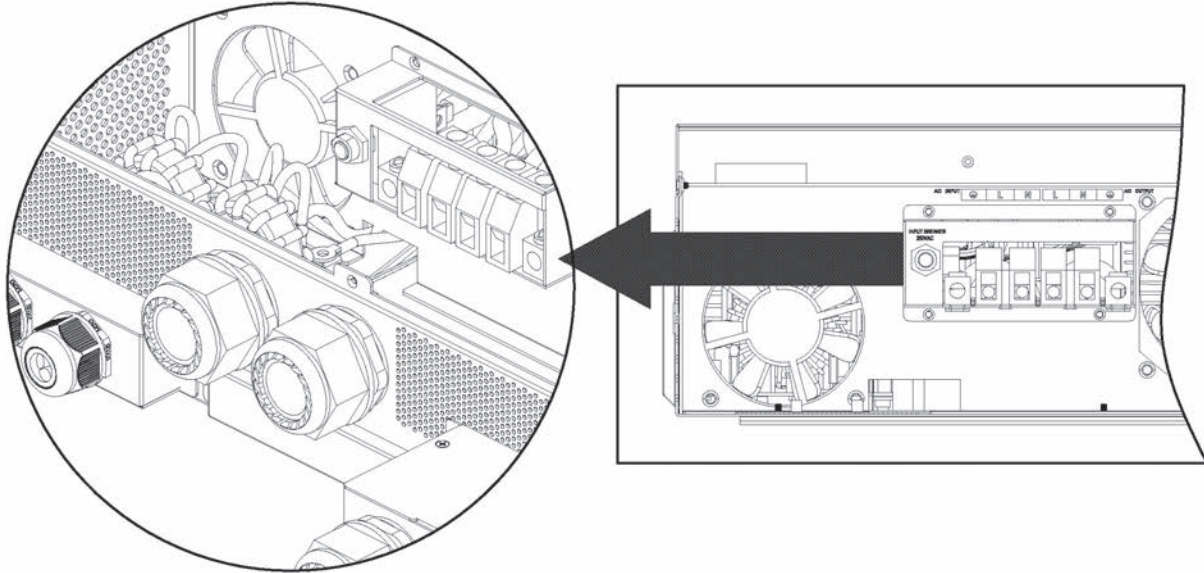

**WARNING:** To avoid potential electrical shock, this unit must be connected to a permanent grounded wiring system or a stand alone grounding rod.

6. Make sure the wires are properly connected and the terminal blocks are torqued to spec.

**CAUTION: Important**

Connect AC wires to the correct terminals. If L and N wires are reversed, it will cause a short-circuit and damage the equipment and loads connected to the system.

**CAUTION:** Appliances with heavy start and run demands, such as air conditioners, require special consideration. For many air conditioners for example, at least 2~3 minutes to restart can be required to allow enough time to balance refrigerant gases. If a power outage occurs and recovers in a short time, it may cause damage to connected appliances. To prevent damage, please check with the manufacturer of the appliance to see if it is equipped with a time-delay function or soft-start feature before installation. Overload of the inverter/charger may trigger a fault leading to sudden loss of AC output power, which may cause damage to appliances with motors/compressors.

## PV Connections

**CAUTION:** Before connecting PV modules/strings, install **separate** DC circuit breakers or a means of disconnect paired with properly sized fuses between inverter and PV array/s. **DO NOT** work with or connect live PV conductors to the unit. Ensure all exposed conductors are safely disconnected from the power source.

NOTE: Use a 600VDC/30A rate circuit breaker. DC rated breakers must be used. The over voltage category of the PV input is II. Please follow the steps below to implement PV module connection.

**WARNING:** Because the inverter/charger is non-isolated, only three types of PV modules are acceptable: monocrystalline and polycrystalline with class A-rated and CIGS modules. To avoid malfunction, do not connect PV modules with possible current leakage. For example, grounded PV modules will cause current leakage to the inverter. When using CIGS modules, please be sure NOT to ground.

**CAUTION:** It is required to use a PV surge protection device. Damage to the inverter can occur from surges such as lightning or short circuiting.

**Step 1:** Check the voltage of the PV modules/strings; ensure open circuit voltage (Voc) is designed to never exceed the units rating (500V DC). This unit is equipped with two PV MPPT string inputs. Ensure the maximum operating amperage (Imp) of each PV input is 18A or less. When using Rapid Shut Down equipment refer to the RSS manufacturer's specifications for per-device and per-string ratings.

**CAUTION:** Exceeding the maximum input voltage can destroy the unit! Check the system before wire connections.

**Step 2:** Disconnect the circuit breaker and switch off the DC disconnect. Follow wiring process below.

- i. Remove 10 mm (3/8in) of insulation for positive and negative conductors.
- ii. Check correct polarity of connection cable from PV modules and PV input connectors at the disconnect. Connect positive pole (+) of connection cable to positive pole (+) of PV input connector. Connect negative pole (-) of connection cable to negative pole (-) of PV input connector.

**Step 3:** Step 3: Make sure the wires are fully inserted and the terminals are torqued to spec.

**CAUTION!** Ensure no wire strands are exposed outside of the terminals blocks. No copper of the conductions should be visible.

It is highly recommended to use red PV wire for positive and black PV wire for negative to reduce risk of reversing polarity in the system.

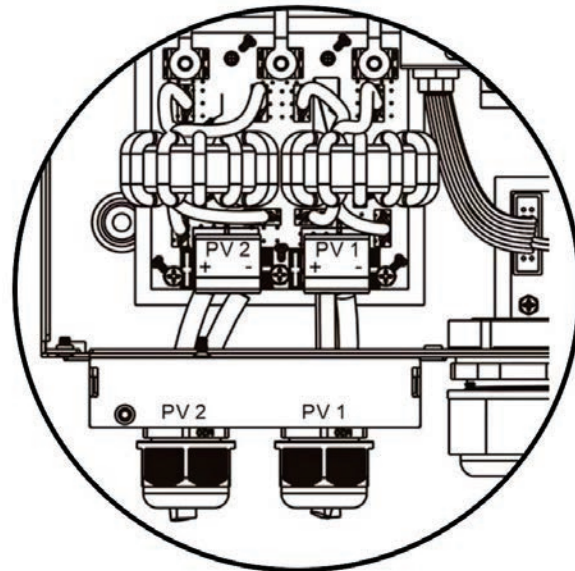

### **WARNING!**

Open circuit Voltage (Voc) of PV strings must not exceed the maximum PV array open circuit voltage of the inverter. Check for environmental impacts on Voc, such as temperature in accordance to the module manufacturers data sheet and reliable weather data for the installation location.

Voltage at Maximum Power (Vmp) of PV strings must be higher than the start-up voltage.

## Parallel Inverter Connections

### 1. Introduction

This model of inverter is a 120V Single-phase unit able to operate in parallel with multiple other units. The parallel function can be used to support multiple electrical system types, including multi-inverter Single-phase, 240 Split-phase, or 3-phase.

**ATTENTION:** Carefully review the paralleling requirements, specifically the current sharing cable connection tables and parallel settings.

#### Battery Bank Considerations:

When designing the system, ensure the battery bank of the system is able to support both the potential max load/s and constant load. Multiple inverters meeting a high load requirement with an undersized battery bank will result in a system shutdown and potentially damage equipment.

#### Recommended Battery Sizing:

Inverters per System	2	3	4	5	6
Battery Capacity (48V)	500AH	800AH	1000AH	1300AH	1600AH

**WARNING!** All inverters of a system must share the same battery bank. Ensure all batteries are connected to common bus bars, with equal cable lengths between both the batteries/bus and inverter/bus connections.

### 2. Parallel Connections for 120V Single-phase:

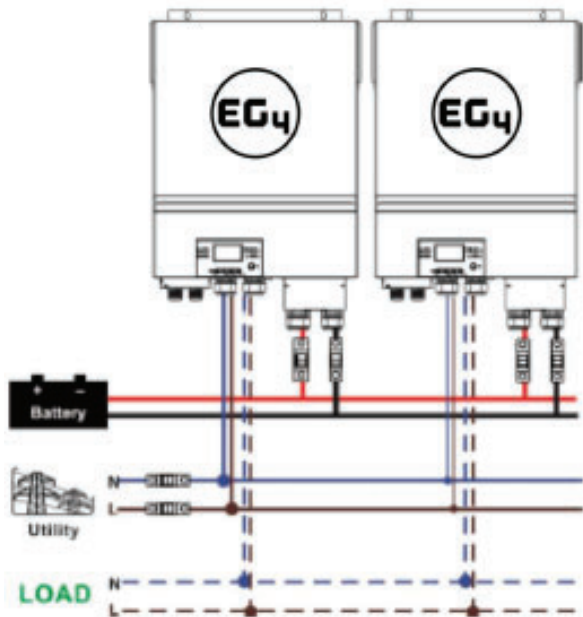

**Current Sharing Cables** - configuration will be noted on each diagram with dashed lines (green when printed in color) in the following format:

- Inverter X Port A → Inverter X Port A
- Inverter X Port B → Inverter X Port B

**WARNING:** Damage to the inverters can occur if current sharing cables are incorrectly installed.

See Split-phase and 3-phase communication connection guides for specifics.

**AC connections are the same for units 3-6.**

#### Communication Connection

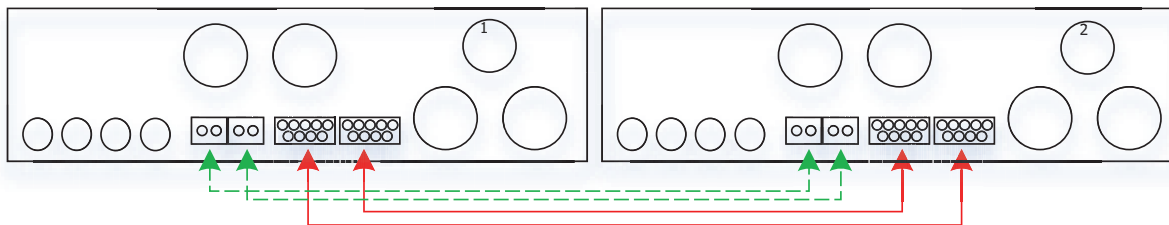

- Inverter 1 Port A → Inverter 2 Port A
- Inverter 1 Port B → Inverter 2 Port B

**Parallel Connections for 120V Single-phase**

**Continued: Communication Connection**

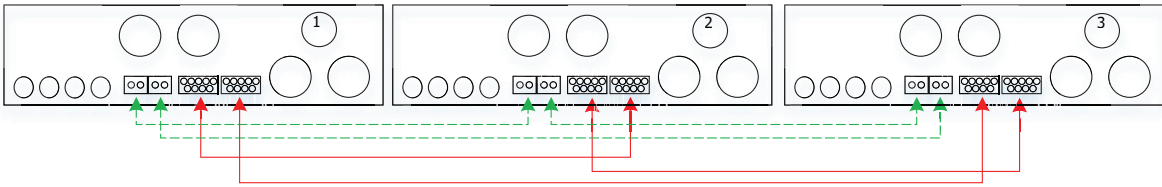

- Inverter 1 Port A → Inverter 2 Port A
- Inverter 1 Port B → Inverter 3 Port B
- Inverter 2 Port B → Inverter 3 Port A

**Communication Connection**

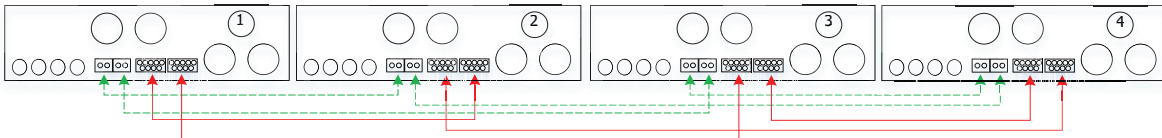

- Inverter 1 Port A → Inverter 2 Port A
- Inverter 1 Port B → Inverter 3 Port B
- Inverter 2 Port B → Inverter 4 Port B
- Inverter 3 Port A → Inverter 4 Port A

**Communication Connection**

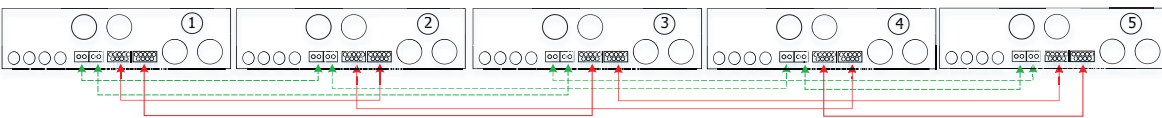

- Inverter 1 Port A → Inverter 2 Port A
- Inverter 1 Port B → Inverter 3 Port B
- Inverter 2 Port B → Inverter 4 Port A
- Inverter 3 Port A → Inverter 5 Port B
- Inverter 4 Port B → Inverter 5 Port A

**Communication Connection**

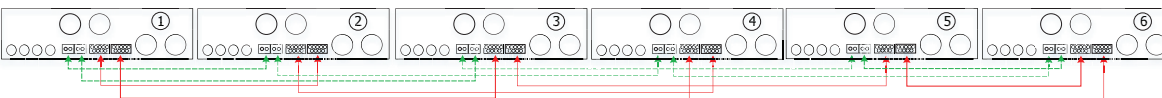

- Inverter 1 Port A → Inverter 2 Port A
- Inverter 1 Port B → Inverter 3 Port B
- Inverter 2 Port B → Inverter 4 Port A
- Inverter 3 Port A → Inverter 5 Port A
- Inverter 4 Port B → Inverter 6 Port A
- Inverter 5 Port B → Inverter 6 Port B



**3. Parallel Connections for 240V Split-phase:**

**WARNING:** Consult a qualified electrician before installing inverter/chargers on lines/legs in an unbalanced configuration. Unbalanced lines/legs can lead to equipment damage and loss of efficiency.

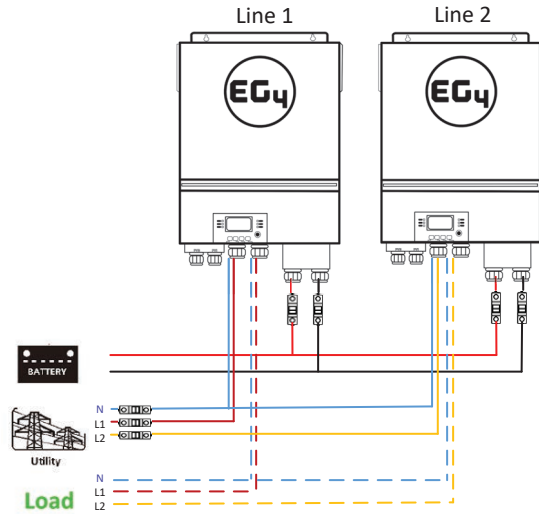

**WARNING:** Do not connect the current sharing cables between inverters operating on different phases/lines (Split-phase and 3-phase configurations). Damage to the inverters can occur if current sharing cables are incorrectly installed.

**Current Sharing Cables** - configuration will be noted on each diagram with dashed lines (green when printed in color) in the following format:

- Inverter X Port A → Inverter X Port A
- Inverter X Port B → Inverter X Port B

**Communication Connection**

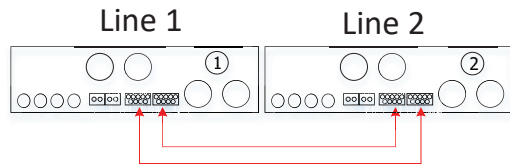

**Communication Connection**

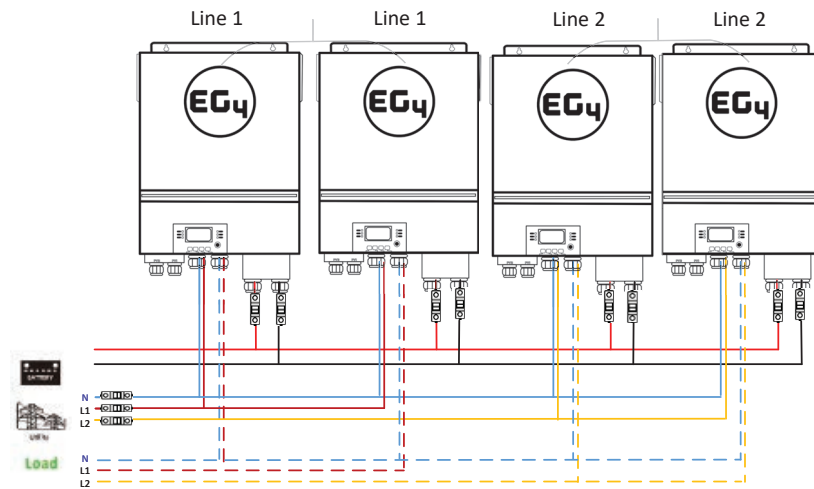

**Communication Connection**

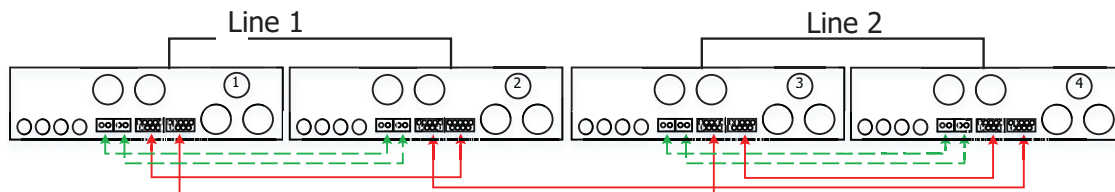

- Inverter 1 Port A → Inverter 2 Port A
- Inverter 1 Port B → Inverter 2 Port B
- Inverter 3 Port A → Inverter 4 Port A
- Inverter 3 Port B → Inverter 4 Port B

**Parallel Connections for 240V Split-phase Continued:**

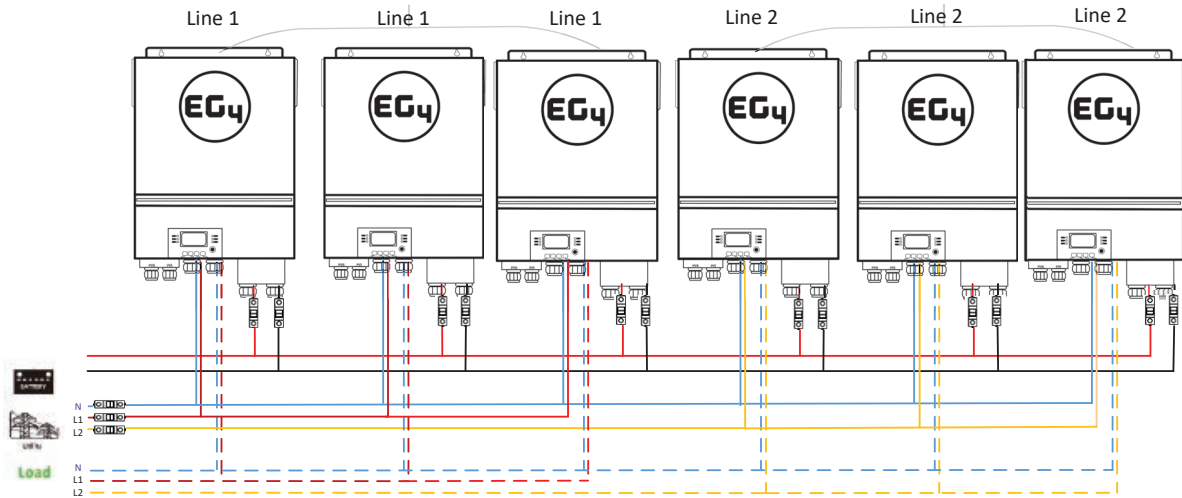

**Communication Connection**

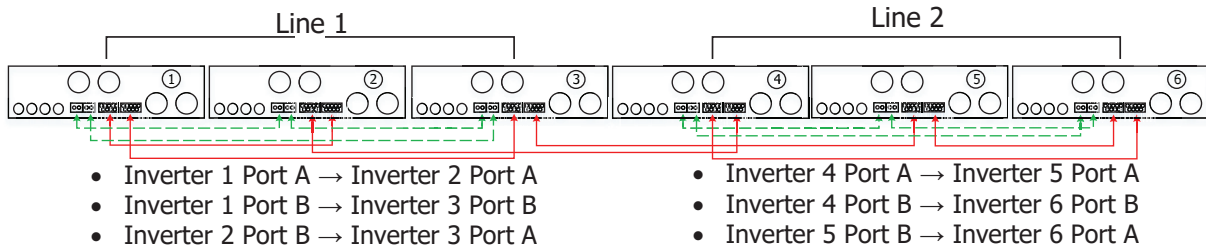

**4. Parallel Connections for 3-phase:**

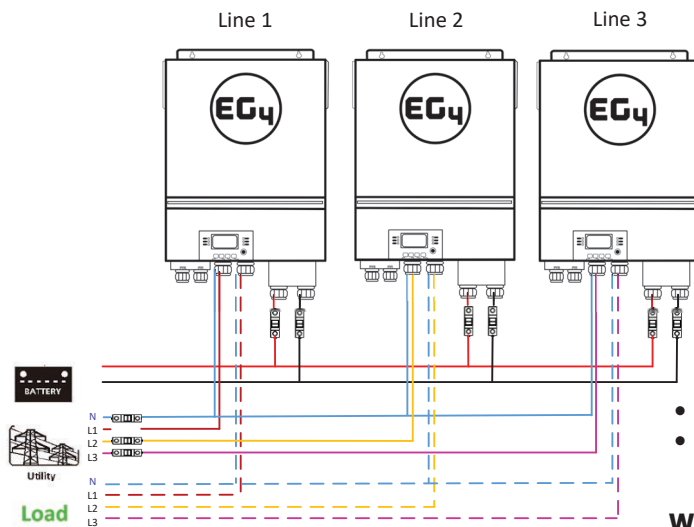

**WARNING:** Consult a qualified electrician before configuring phase/line inbalanced systems. Unbalanced legs can lead to equipment damage and loss of efficiency.

**Current Sharing Cables** - configuration will be noted on each diagram with dashed lines (green when printed in color) in the following format:

- Inverter X Port A → Inverter X Port A
- Inverter X Port B → Inverter X Port B

**WARNING:** Do not connect the current sharing cables between inverters operating on different phases (Split-phase and 3-phase configurations). Damage to the inverters can occur if current sharing cables are incorrectly installed.

**Communication Connection**

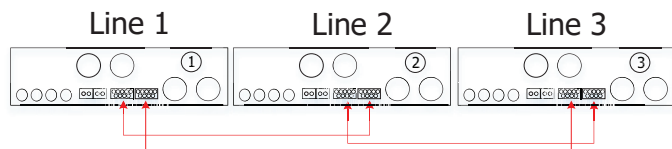

**Parallel Connections for 3-phase Continued:**

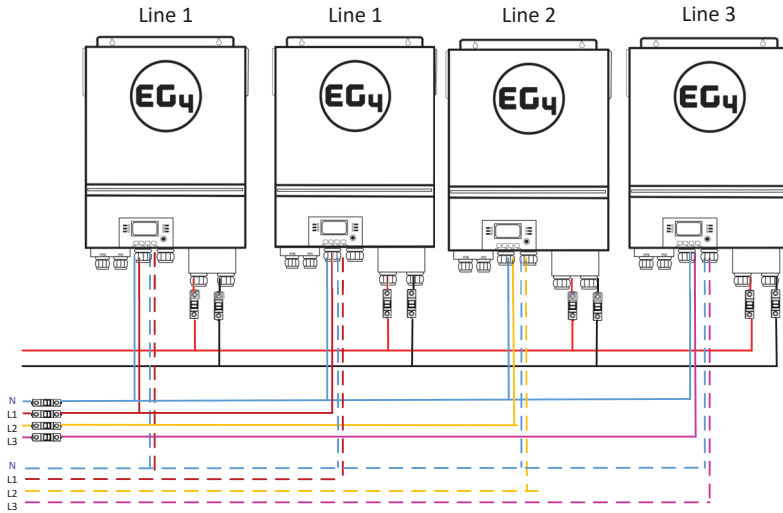

**Communication Connection**

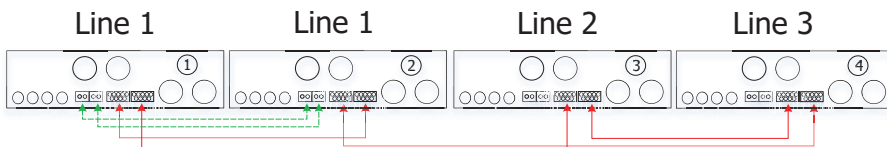

- Inverter 1 Port A → Inverter 2 Port A
- Inverter 1 Port B → Inverter 2 Port B

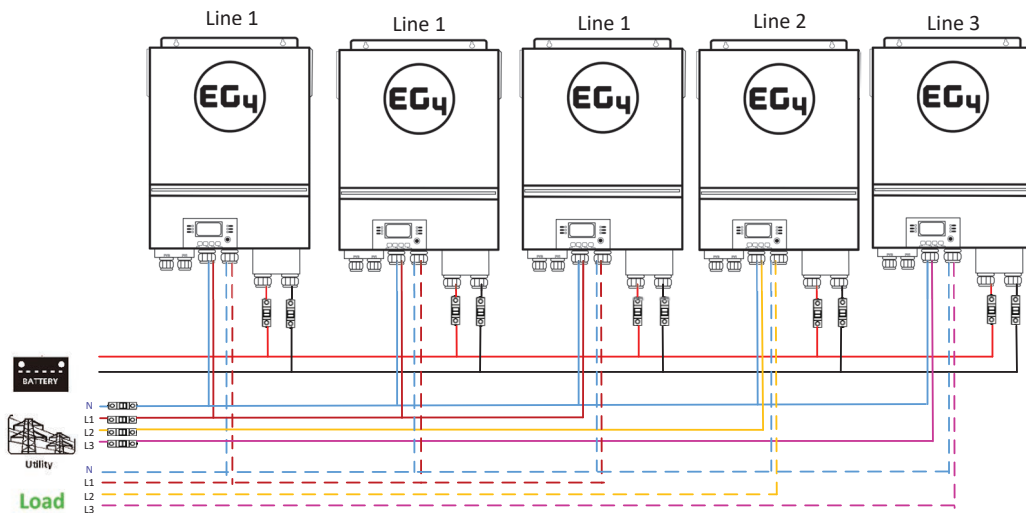

**Communication Connection**

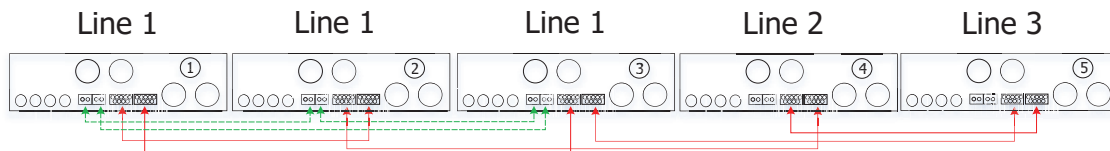

- Inverter 1 Port A → Inverter 2 Port A
- Inverter 1 Port B → Inverter 3 Port B
- Inverter 2 Port B → Inverter 3 Port A



**Parallel Connections for 3-phase Continued:**

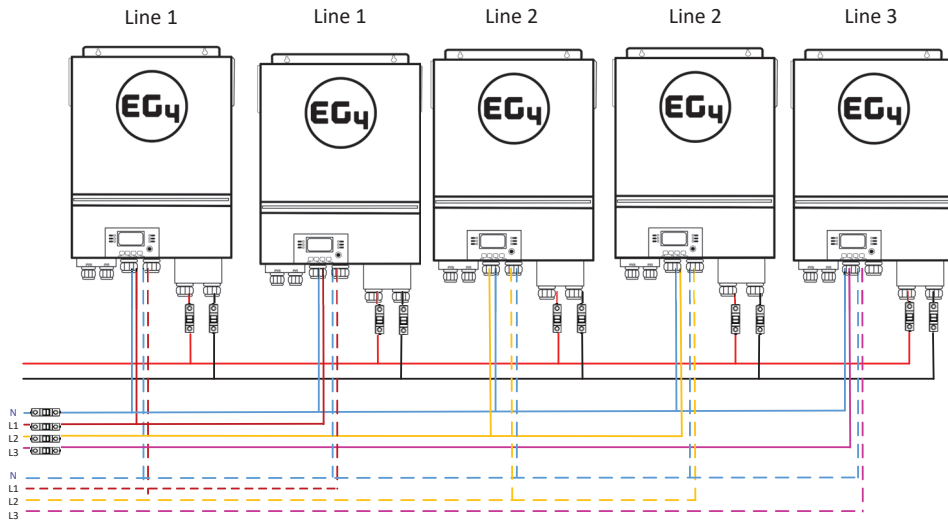

**Communication Connection**

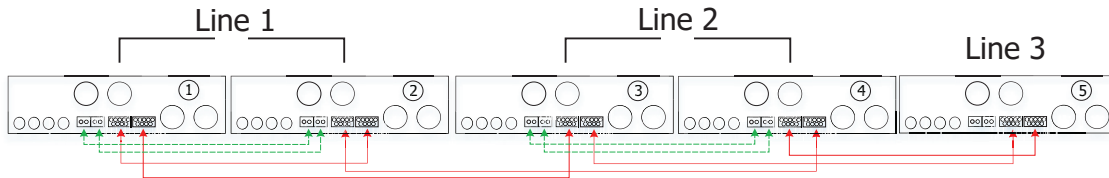

- Inverter 1 Port A → Inverter 2 Port A
- Inverter 3 Port A → Inverter 4 Port A
- Inverter 1 Port B → Inverter 2 Port B
- Inverter 3 Port B → Inverter 4 Port B

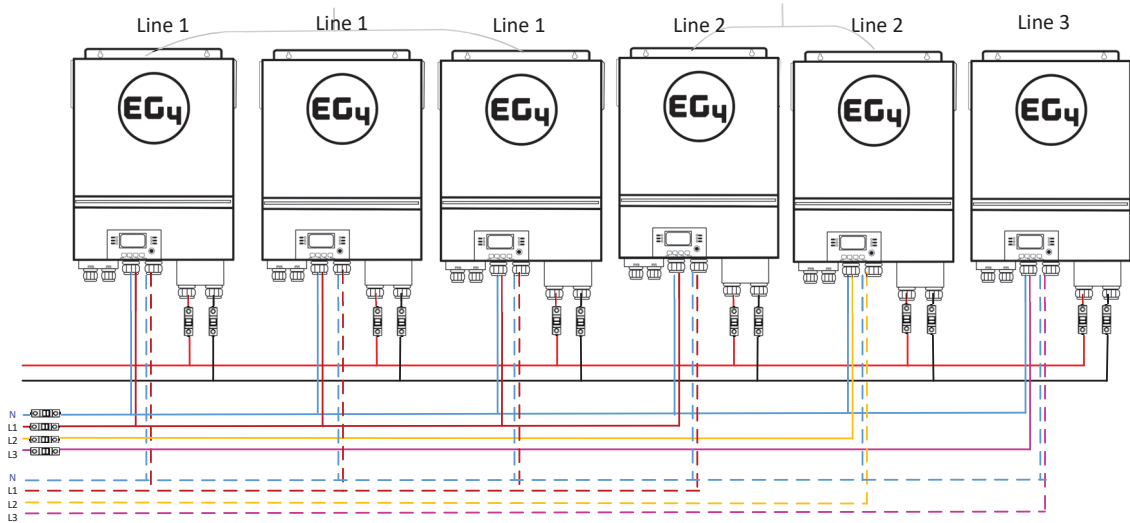

**Communication Connection**

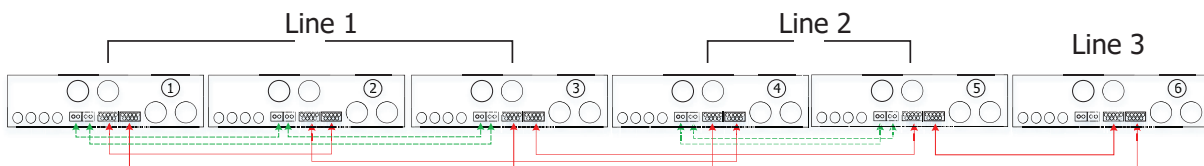

- Inverter 1 Port A → Inverter 2 Port A
- Inverter 4 Port A → Inverter 5 Port A
- Inverter 1 Port B → Inverter 3 Port B
- Inverter 4 Port B → Inverter 5 Port B
- Inverter 2 Port B → Inverter 3 Port A

**Parallel Connections for 3-phase Continued:**

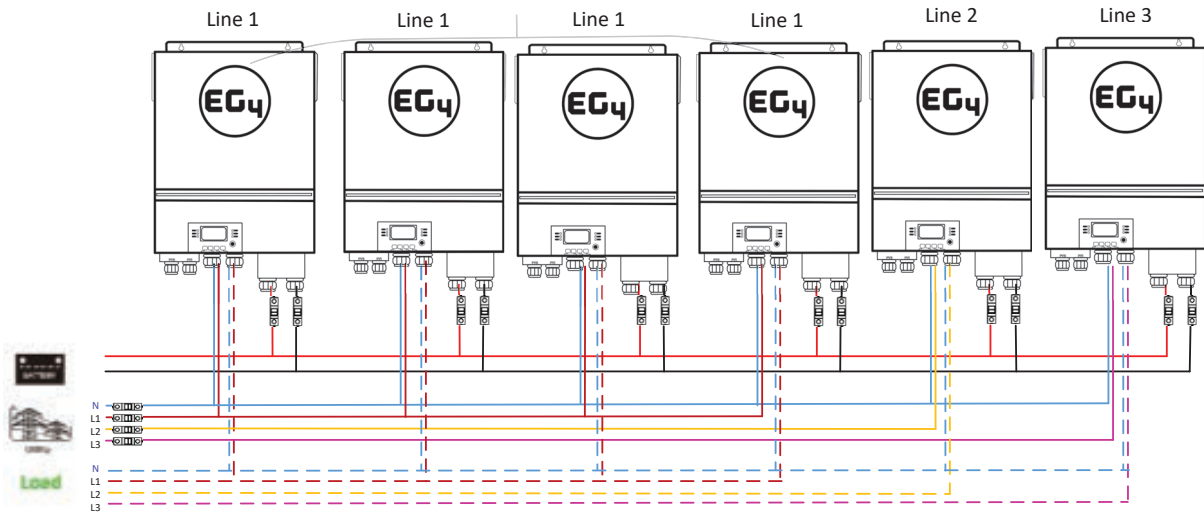

**Communication Connection**

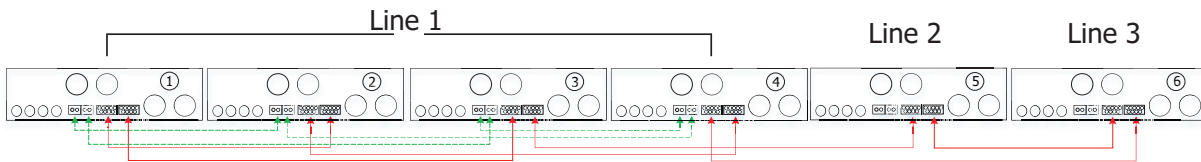

- Inverter 1 Port A → Inverter 2 Port A
- Inverter 1 Port B → Inverter 3 Port B
- Inverter 2 Port B → Inverter 4 Port B
- Inverter 3 Port A → Inverter 4 Port A

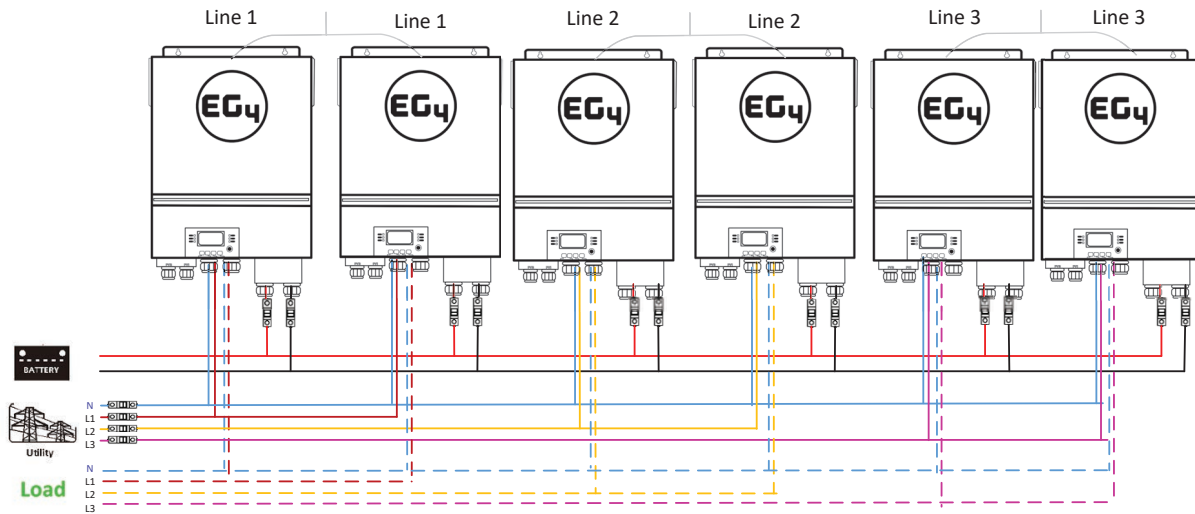

**Communication Connection**

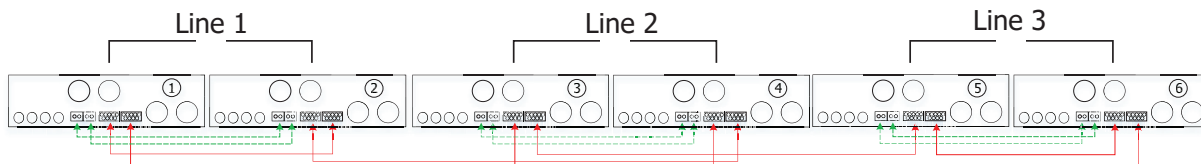

- Inverter 1 Port A → Inverter 2 Port A
- Inverter 1 Port B → Inverter 2 Port B
- Inverter 3 Port A → Inverter 4 Port A
- Inverter 3 Port B → Inverter 4 Port B
- Inverter 5 Port A → Inverter 6 Port A
- Inverter 5 Port B → Inverter 6 Port B

# BMS Communication Installation- EG4-LL

## 1. Introduction

When connecting to LFP battery, it is recommended to purchase a custom-made RJ45 communication cable. Please check with your dealer or integrator for details.

This custom-made RJ45 communication cable delivers information and signal between lithium battery and the inverter. The information is listed below:

- Re-configure charging voltage, charging current and battery discharge cut-off voltage according to the lithium battery parameters.
- Starting and stopping of charging is based on the batteries SOC (State Of Charge)

## 2. Pin Assignment for BMS Communication Port

	Definition
PIN 1	RS232TX
PIN 2	RS232RX
PIN 3	RS485B
PIN 4	NC
PIN 5	RS485A
PIN 6	CANH
PIN 7	CANL
PIN 8	GND

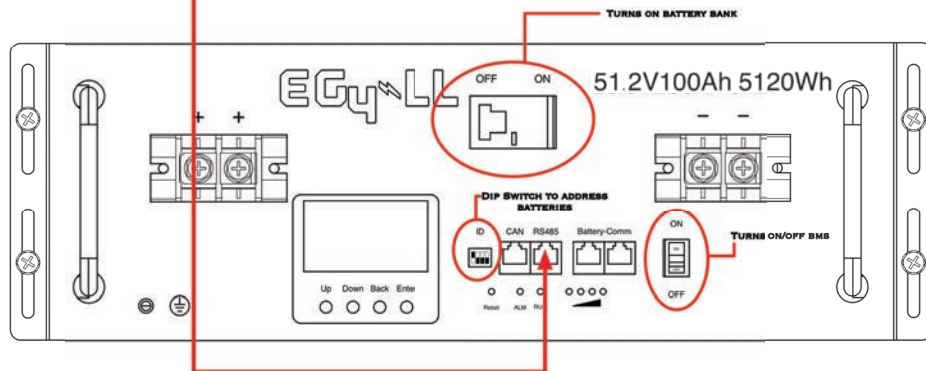
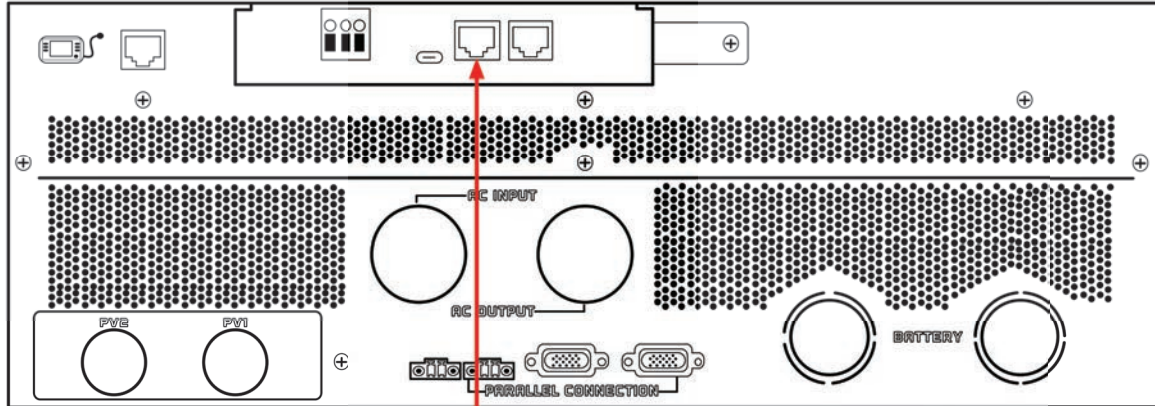
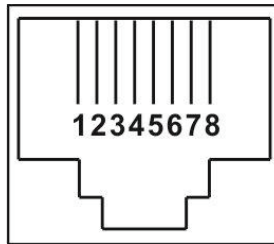

### Battery Networking- EG4-LL

Using the 1ft RS485 cable interconnect your batteries as illustrated in the diagram below.

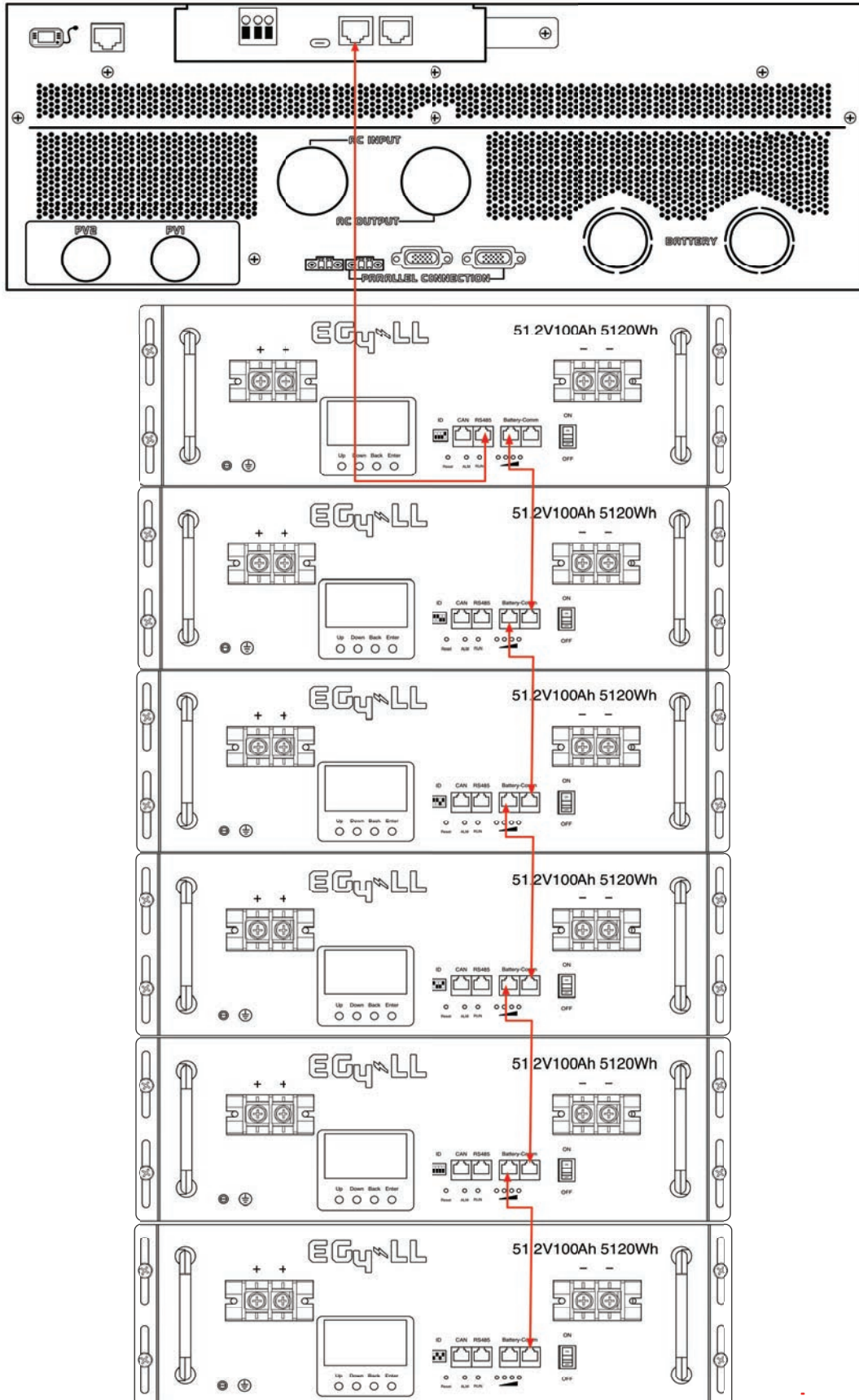

### Battery Networking-LiFePower4

Using the 1ft RS485 cable interconnect your batteries as illustrated in the diagram below.

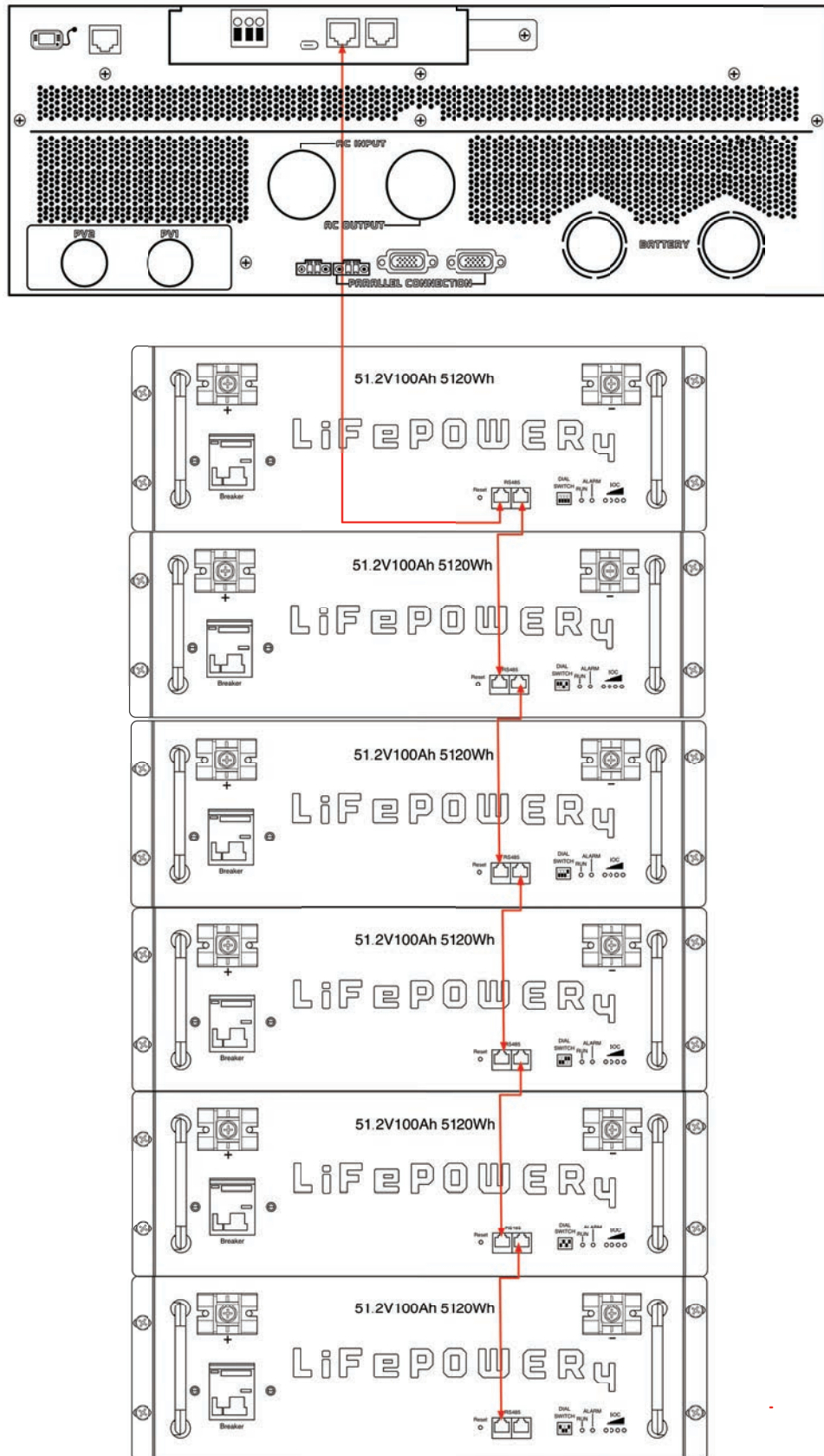



### Settings for EG4 Lithium Batteries- Master/Slave

1). Dip Switch: There are 4 Dip Switches which set different baud rates and battery group addresses. If switch position is turned to the "OFF" position, it means "0". If switch position is turned to the "ON" position, it means "1".

#### EG4-LL Battery

- Dip 1, 2, and 3 are in the "ON" position \*on = down
- Dip 4 is in the "OFF" position \*off = up
- The 1-3 "ON" & 4 "OFF" configuration is to indicate Master battery status and is reserved for communications with the inverter.
- A Max of 16 batteries can communicate in a single battery bank using different dipswitch addresses.

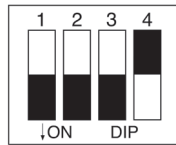

#### EG4-LifePower4 Battery

- Dip 1, 2, 3, and 4 are in the "OFF" position \*off = down
- The ALL "OFF" position is to indicate the Master battery status and is reserved for communications with the inverter
- A Max of 16 batteries can communicate in a single battery bank.

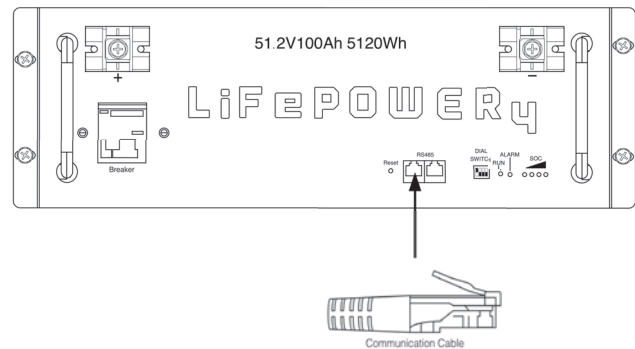
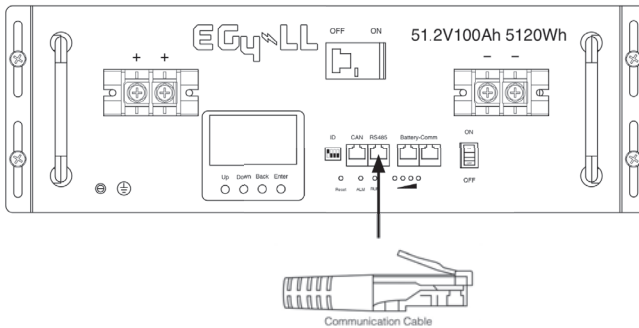
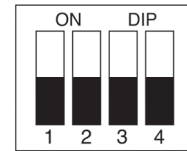

**Please Note: If you change the dipswitches, you must power cycle the batteries for the BMS to recognize the new dipswitch address.**

### 2). Installation

Step 1. Use the RS485 cable to connect the inverter and Lithium battery as Fig 1.

Step 2. Switch on the battery breaker/s.

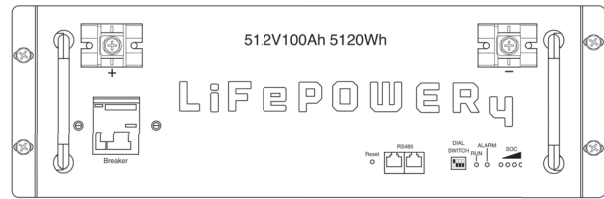
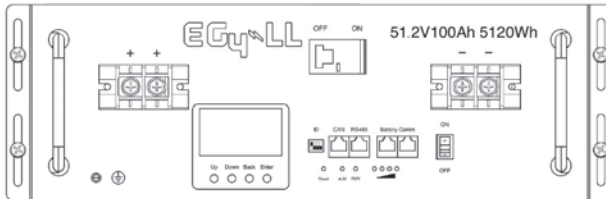

Step 3. Turn on the inverter.

Step 4. Select battery type as "EG4" in LCD program 5 for the Master inverter. For other paralleled inverters, set to "USE".

If communication between the inverter and battery is successful, the battery icon  on LCD display will flash

**NOTE:** For EG4-LL ensure the red power switch is set to "ON" as well as the breaker.

**NOTE:** Even with the EG4 batteries having built-in breakers, a minimum 150A in line breaker is required, and a 200A in line breaker is recommended.

**NOTE:** Refer to each battery manual for setting master and follower battery address settings.

## Final Assembly

After completing the wiring process, slide the front cover part way back on, then re-connect the three front cover cables (fig. 1). Finish by sliding the front cover all the way back on and securing the screws.

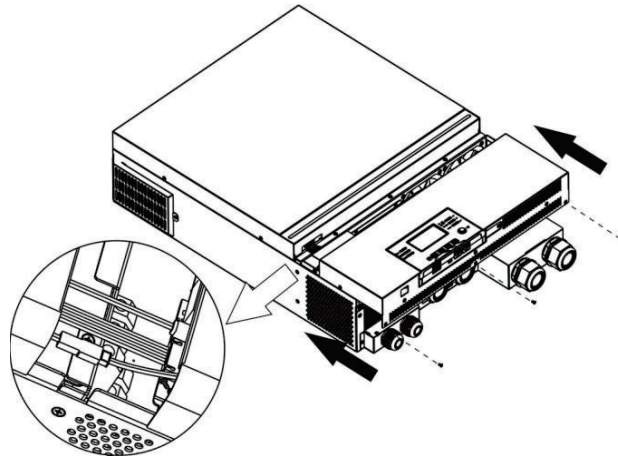

Figure 1.

## Remote Display Panel Installation

For remote system viewing, the LCD module can be removed from the front cover and installed with an optional communication cable. Follow the steps below for remote display setup.

### Step 1. Removing the Display

1. Remove the screw on the bottom of the display, remove the metal retention tab.
2. Slide the display out of the front cover.
3. Detach the cable from the original communication port. Tuck the cable into the front cover opening.
4. Replace the retention plate onto the front cover.

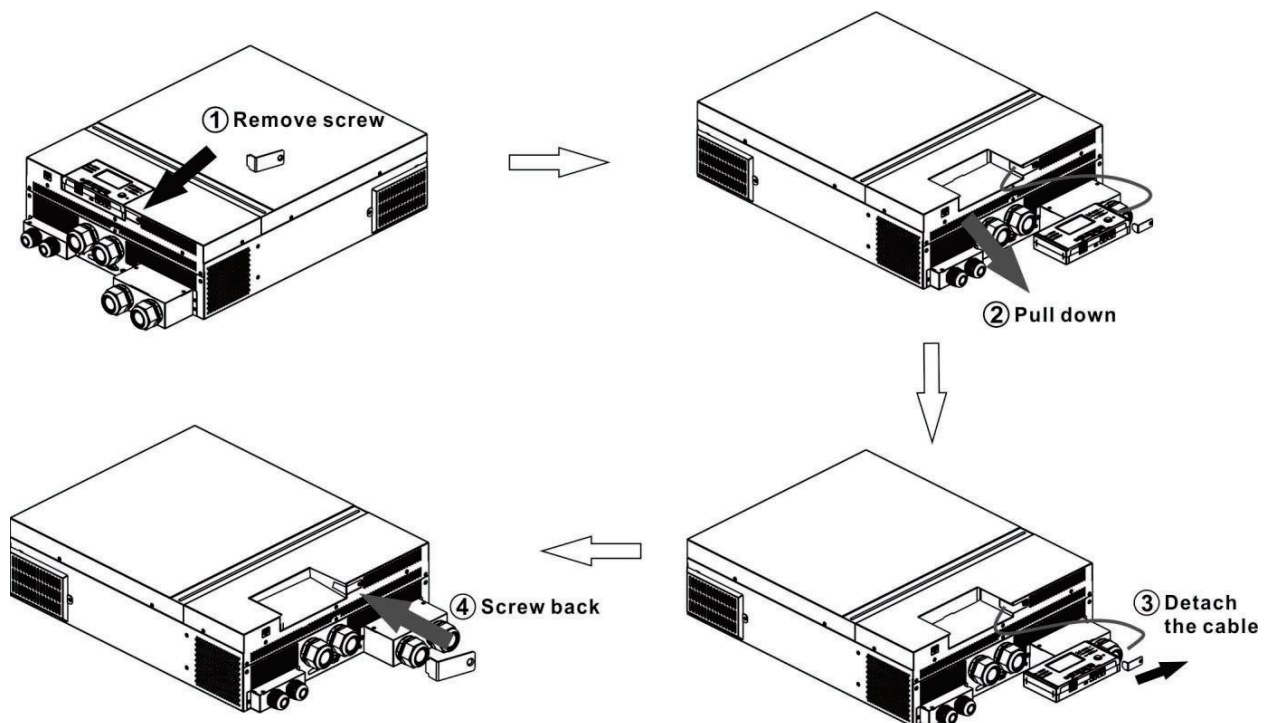

**Step 2.** Prepare the mounting location using the holes on the back of the display for reference. For a transferable template, use a piece of paper pressed against the back of the display and mark with a pen or make small holes in the paper.

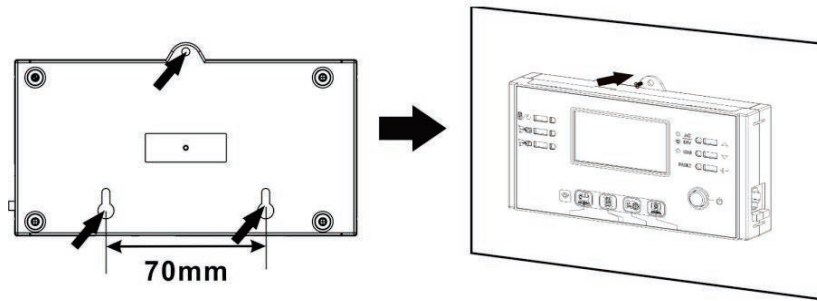

**Note:** Ensure the screw heads and diameter are the correct size to avoid damaging the display.

**Step 3.** After the display is securely mounted, connect the display to the inverter using a RJ45 cable (recommended CAT5e or better) as shown below.

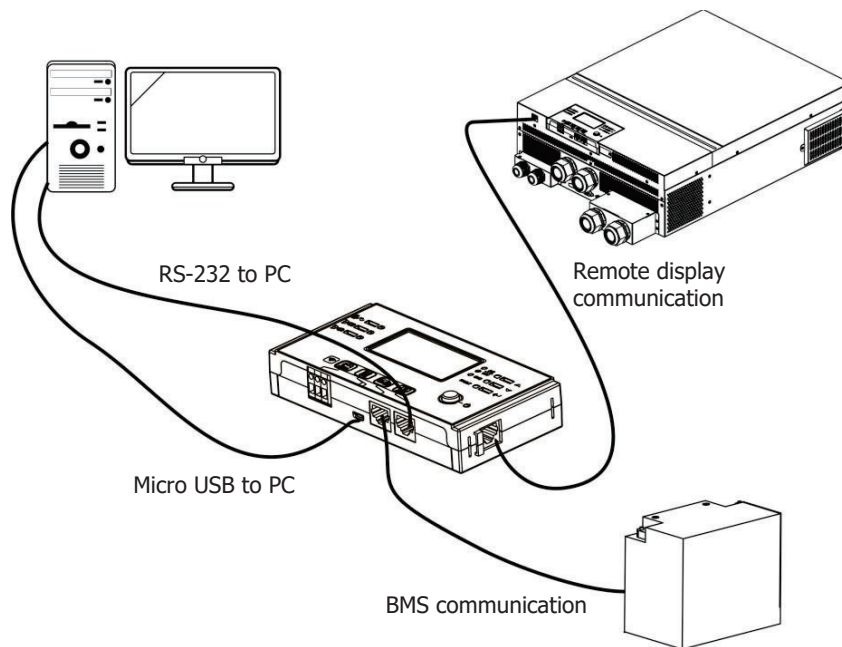



## OPERATING THE INVERTER/CHARGER

### Power ON/OFF

After completing installation of the unit it is ready for powering on for setup. Start by pressing the On/Off switch (located on the display panel) to turn on the unit.

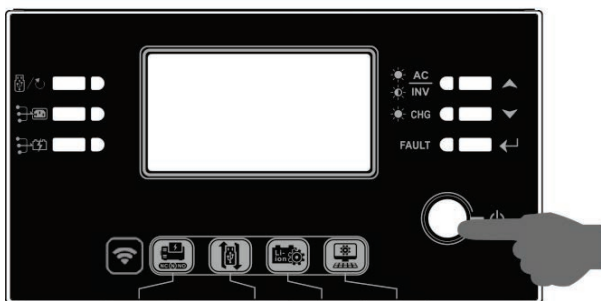

### Inverter Start-Up

After the inverter is turned on, the WELCOME light show will be started with RGB LED bar. It will slowly cycle through entire spectrum of nine colors for ~10-15 seconds, and the LCD screen will display a countdown. After initialization, the LED status bar will switch to the default color. See the LCD settings sections to adjust the default.

### Display Panel Layout



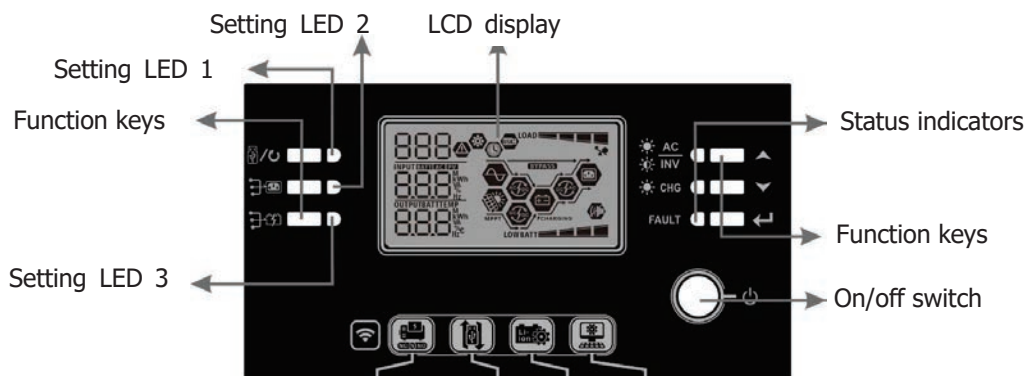



The operation and the LCD module, shown in the chart below, includes six indicators, six function keys, on/off switch and a LCD display to indicate the operating status and input/output power information.



#### Indicators

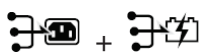



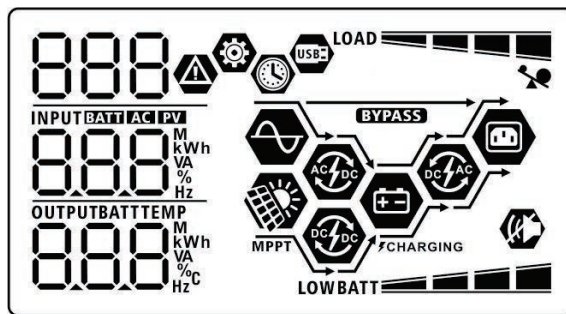

LED Indicator	Color	Solid/Flashing	Messages
<b>Setting LED 1</b>	Green	Solid On	Output powered by utility
<b>Setting LED 2</b>	Green	Solid On	Output powered by PV
<b>Setting LED 3</b>	Green	Solid On	Output powered by battery
<b>Status indicators</b>	☀️ <b>AC</b> ⚡️ <b>INV</b>	Solid On	Output is available in line mode
		Flashing	Output is powered by battery in battery mode
	☀️ <b>CHG</b>	Solid On	Battery is fully charged
		Flashing	Battery is charging.
<b>FAULT</b>	Red	Solid On	Fault mode
		Flashing	Warning mode

**Function Keys**

Function Key	Description	
	ESC	Exit the setting
	USB function setting	Select USB OTG functions
	Timer setting for the Output source priority	Setup the timer for prioritizing the output source
	Timer setting for the Charger source priority	Setup the timer for prioritizing the charger source
		Press these two keys at the same time to switch RGB LED bar between output source priority and battery discharge/charge status.
	Up	To last selection
	Down	To next selection
	Enter	To confirm/enter the selection in setting mode

**Display Icons**



Icon	Function description
<b>Input Source Information</b>	
	Indicates the AC input.
	Indicates the PV input
	Indicates input voltage, input frequency, PV voltage, charger current, charger power, battery voltage. Use the up/down arrows to scroll.
<b>Configuration Program and Fault Information</b>	
	Indicates the setting programs.
	Indicates the warning and fault codes. Warning: 88 with triangle flashing with warning code. Fault: F88 lighting with fault code
<b>Output Information</b>	
	Displays output voltage, frequency, load percent, load in VA, load in watts, and discharging current. Use the up/down arrows to scroll.
<b>Battery Information</b>	
	Indicates battery level by 0-24%, 25-49%, 50-74% and 75-100% in battery mode and charging status in line mode.
<b>NOTE:</b> When battery is charging, it will present battery charging status.	

Status	Battery voltage	LCD Display
Constant Current mode / Constant Voltage mode	<2V/cell	4 bars will flash in turns.
	2 ~ 2.083V/cell	Bottom bar will be on and the other three bars will flash in turns.
	2.083 ~ 2.167V/cell	Bottom two bars will be on and the other two bars will flash in turns.
	> 2.167 V/cell	Bottom three bars will be on and the top bar will flash.
Floating mode. Batteries are fully charged.		4 bars will be on.
In battery mode, it will present battery capacity.		
Load Percentage	Battery Voltage	LCD Display
Load >50%	< 1.85V/cell	<b>LOWBATT</b>
	1.85V/cell ~ 1.933V/cell	<b>BATT</b>
	1.933V/cell ~ 2.017V/cell	<b>BATT</b>
	> 2.017V/cell	<b>BATT</b>
Load < 50%	< 1.892V/cell	<b>LOWBATT</b>
	1.892V/cell ~ 1.975V/cell	<b>BATT</b>
	1.975V/cell ~ 2.058V/cell	<b>BATT</b>
	> 2.058V/cell	<b>BATT</b>
<b>Load Information</b>		
	Indicates overload.	
	Indicates the load level by 0-24%, 25-49%, 50-74% and 75-100%.	
	0%~24%	25%~49%
	<b>LOAD</b>	<b>LOAD</b>
	50%~74%	75%~100%
<b>LOAD</b>	<b>LOAD</b>	
<b>Mode Operation Information</b>		
	Indicates unit connects to the mains.	
	Indicates unit connects to the PV panel.	
<b>BYPASS</b>	Indicates load is supplied by utility power.	
	Indicates the utility charger circuit is working.	
	Indicates the solar charger circuit is working.	
	Indicates the DC/AC inverter circuit is working.	
	Indicates unit alarm is disabled.	
	Indicates USB disk is connected.	
	Indicates timer setting or time display	

## Display Screens

Display information can be cycled through by pressing the "UP" or "DOWN" buttons from the main screen. The screen options are shown in the order in the table below.

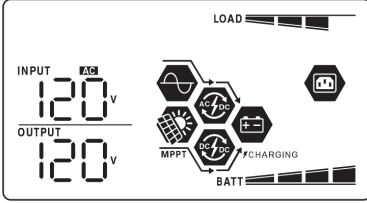
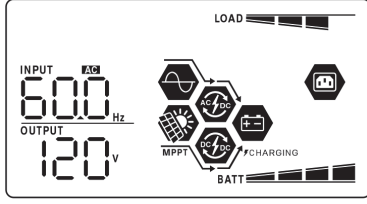
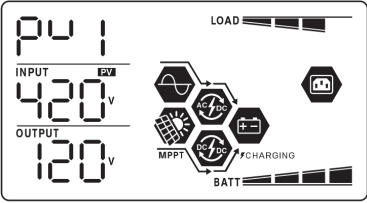
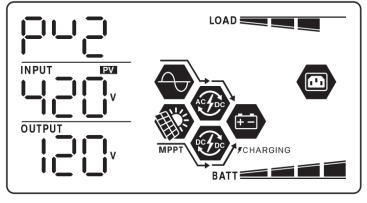
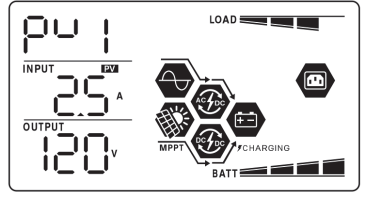
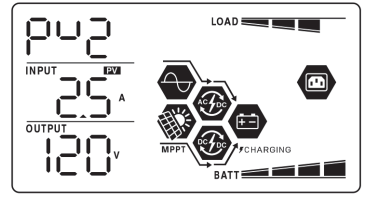
Selectable information	LCD display
Input voltage/Output voltage (Default Display Screen)	Input voltage=120V, output voltage=120V 
Input frequency	Input frequency=60Hz 
PV voltage	PV1 voltage=420V 
	PV2 voltage=420V 
PV current	PV1 current = 2.5A 
	PV2 current = 2.5A 

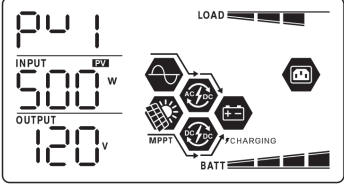
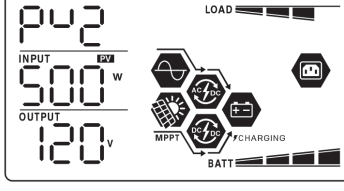
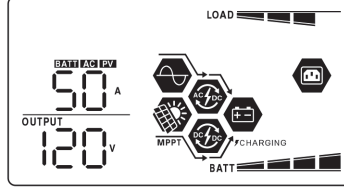
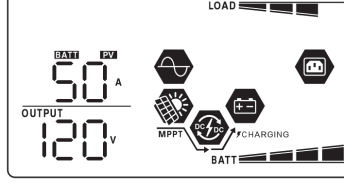
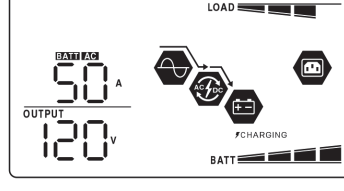
<p>PV power</p>	<p>PV1 power = 500W</p> 
	<p>PV2 power = 500W</p> 
<p>Charging current</p>	<p>AC and PV charging current=50A</p> 
	<p>PV charging current=50A</p> 
	<p>AC charging current=50A</p> 

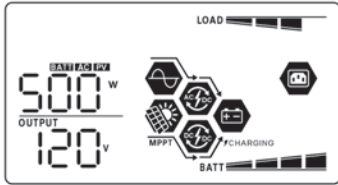
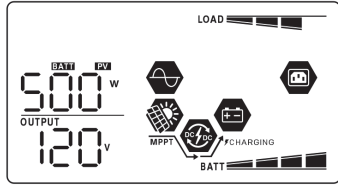
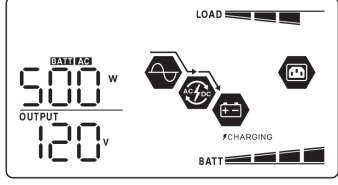
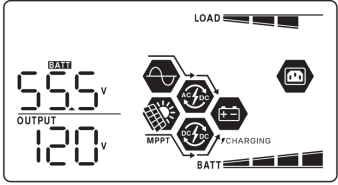
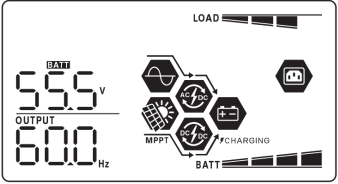
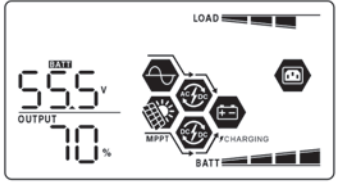
<p>Charging power</p>	<p>AC and PV charging power=500W</p>  <p>PV charging power=500W</p>  <p>AC charging power=500W</p> 
<p>Battery voltage and output voltage</p>	<p>Battery voltage=55.5V, output voltage=120V</p> 
<p>Output frequency</p>	<p>Output frequency=60Hz</p> 
<p>Load percentage</p>	<p>Load percent=70%</p> 

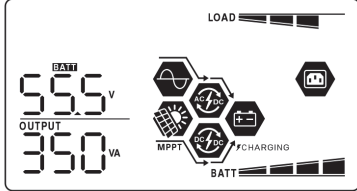
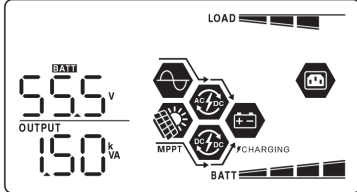
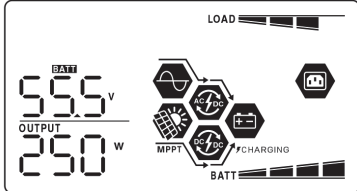
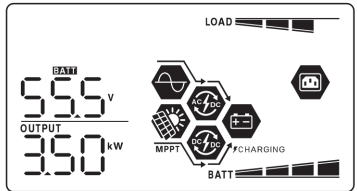
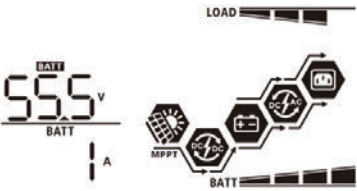
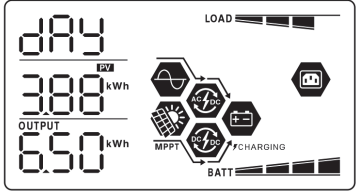

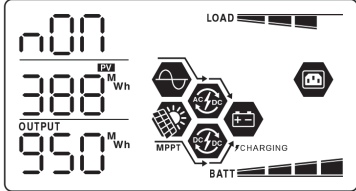
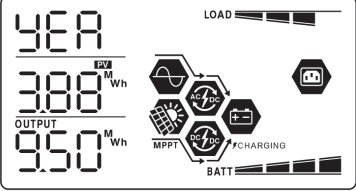
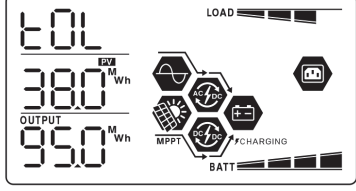
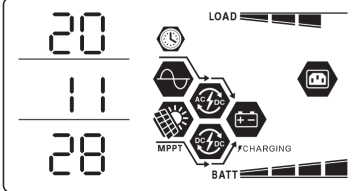
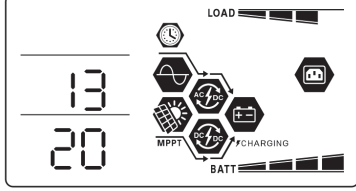
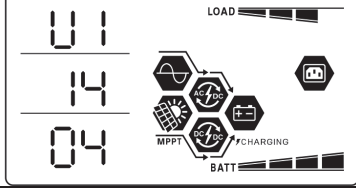

<p>Load in VA</p>	<p>When connected load is lower than 1kVA, load in VA will display xxxVA like below chart.</p>  <p>When load is larger than 1kVA (<math>\geq 1\text{kVA}</math>), load in VA will present x.xkVA like below chart.</p> 
<p>Load in Watt</p>	<p>When load is lower than 1kW, load in W will display xxxW like below chart.</p>  <p>When load is larger than 1kW (<math>\geq 1\text{kW}</math>), load in W will display x.xkW like below chart.</p> 
<p>Battery voltage/DC discharging current</p>	<p>Battery voltage=55.5V, discharging current=1A</p> 
<p>Example of PV production for a day and consumption for a day.</p>	<p>Production = 3.88kWh Consumption = 6.50kWh.</p> 

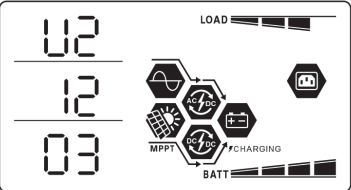
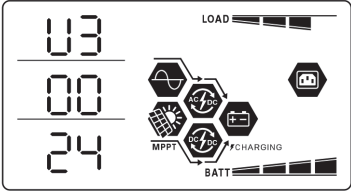
<p>Example of PV production for a month and consumption of energy for a month.</p>	<p>Production = 388kWh, Consumption = 950kWh.</p> 
<p>Example of PV production for a year and consumption of energy for a year.</p>	<p>Production = 3.88MWh Consumption = 9.50MWh.</p> 
<p>Example of total system PV production and consumption.</p>	<p>Total production = 38.8MWh Total consumption = 95.0MWh.</p> 
<p>Date.</p>	<p>Date, example Nov 28, 2020.</p> 
<p>Time.</p>	<p>Time, example 13:20.</p> 
<p>Main CPU version.</p>	<p>Main CPU version 00014.04.</p> 





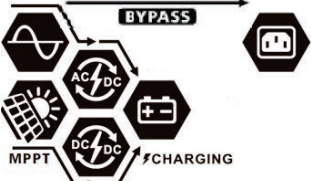
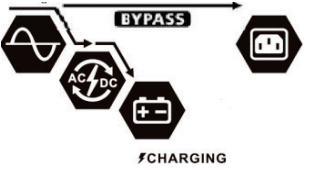
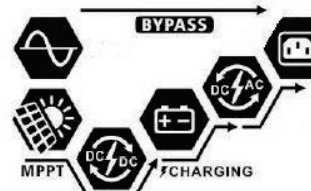
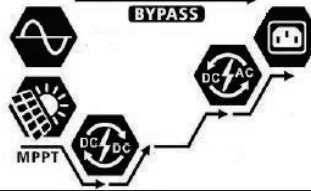
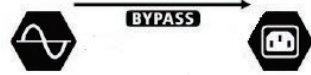

<p>Secondary CPU version checking.</p>	<p>Secondary CPU version 00012.03.</p> 
<p>Wi-Fi version checking.</p>	<p>Wi-Fi version 00000.24.</p> 

### Operating Modes

Operation mode	Description	LCD display
<p>Standby mode</p> <p><b>Note:</b> *Standby mode: The inverter is not turned on yet but at this time, the inverter can charge battery without AC output.</p>		<p>Charging by utility and PV energy.</p> 
	<p>No output is supplied by the unit but it still can charge batteries.</p>	<p>Charging by utility.</p> 
		<p>Charging by PV energy.</p> 
		<p>No charging.</p> 

Operation mode	Description	LCD display
<p>Fault mode</p> <p><b>Note:</b></p> <p><i>*Fault mode: Errors are caused by inside circuit error or external reasons such as over temperature, output short circuit and so on.</i></p>	<p>System is not charging, regardless of PV and grid/AC power in being available.</p>	<p>Not charging.</p> 
<p>Line Mode</p>	<p>The unit will provide output power from the mains. It will also charge the battery at line mode.</p>	<p>Charging by utility and PV energy.</p>  <p>Charging by utility.</p>  <p>If "SUB" (solar first) is selected as output source priority and solar energy is not sufficient to power the load/s, solar energy and the utility will provide the loads and charge the battery at the same time.</p> 
<p>Line Mode</p>	<p>The unit will provide output power from the mains. It will also charge the battery at line mode.</p>	<p>If either "SUB" (solar first) or "SBU" is selected as output source priority and battery is not connected, solar energy and the utility will power the load/s.</p>  <p>Power from utility.</p> 

Operation mode	Description	LCD display
Battery Mode		Power from battery and PV energy. 
	The unit will provide output power from battery and/or PV power.	PV energy will supply power to the loads and charge battery at the same time. No utility is available. 
		Power from battery only. 
		Power from PV energy only. 

## System Settings





### General Setting









After pressing and holding “←” button for 3 seconds, the unit will enter the Settings Menu.









Press “▲” or “▼” button to select setting programs.







Press “←” button to confirm you selection or “⏏/↺” button to exit.









### Setting Programs:

Program	Description	Selectable option	
00	Exit setting mode	Escape 00  ESC	
01	Output source priority: To configure load power source priority	Utility first (default) 01  USb	Utility will provide power to the loads as first priority. Solar and battery energy will provide power to the loads only when utility power is not available.
		Solar first 01  SUB	Solar energy provides power to the loads as first priority. If solar energy is not sufficient to power all connected loads, Utility energy will supply power to the loads at the same time.
		SBU priority 01  Sbu	Solar energy provides power to the loads as first priority. If solar energy is not sufficient to power all connected loads, battery energy will supply power to the loads at the same time. Utility provides power to the loads only when battery voltage drops to either low-level warning voltage or the setting point in program 12.
02	Maximum charging current: To configure total charging current for solar and utility chargers. (Max. charging current = utility charging current + solar charging current)	60A (default) 02  60 <sup>A</sup>	Setting range is from 10A to 120A. Increment of each click is 10A.

03	AC input voltage range	Appliances (default) 03  APL	If selected, acceptable AC input voltage range will be within 80-140VAC.
		UPS 03  UPS	If selected, acceptable AC input voltage range will be within 90-140VAC.
05	Battery type	AGM 05  AGM	Flooded 05  FLd
		User-Defined 05  USE	If "User-Defined" is selected, battery charge voltage and low DC cut-off voltage can be set up in program 26, 27 and 29.
		EG4 (default) <div style="border: 1px solid black; padding: 5px; display: inline-block;">                     05                       EG4                 </div>	If using EG4 batteries you will use this battery type for BMS communications. If this battery type is selected settings 2,26, 27 will be configured by the BMS.
		Lib-protocol compatible battery 05  LIB	
		3 <sup>rd</sup> party Lithium battery 05  LIC	

06	Auto restart when overload occurs	Restart disable (default) 06  LFD	Restart enable 06  LFE
07	Auto restart when over temperature occurs	Restart disable (default) 07  tFd	Restart enable 07  tFE
09	Output frequency	50Hz 09  50 <sub>Hz</sub>	60Hz (default) 09  60 <sub>Hz</sub>
10	Output voltage	110V 10  110 <sub>v</sub>	120V (default) 10  120 <sub>v</sub>
		127V 10  127 <sub>v</sub>	









<p>11</p>	<p>Maximum utility charging current</p> <p><b>Note:</b> If setting value in program 02 is smaller than that in program in 11, the inverter will apply charging current from program 02 for utility charger.</p>	<p>30A (default)</p> 	<p>Setting range is 2A, then from 10A to 120A. Increment of each click is 10A.</p>
<p>12</p>	<p>Setting voltage point back to utility source when selecting "SBU" (SBU priority) in program 01.</p>	<p>46V (default)</p> 	<p>Setting range is from 44V to 51V. Increment of each click is 1V.</p>
<p>12</p>	<p>Setting voltage point back to utility source when selecting "SBU" (SBU priority) in program 01.</p>	<p>SOC 10% (default for Lithium)</p> 	<p>If the battery type (#05) set as Lithium, this setting will change to SOC automatically. Adjustable range is 5% to 95%. Increment of each click is 5%.</p>
<p>13</p>	<p>Setting voltage point back to battery mode when selecting "SBU" (SBU priority) in program 01.</p>	<p>Battery fully charged</p> 	<p>54V (default)</p> 
<p>13</p>	<p>Setting voltage point back to battery mode when selecting "SBU" (SBU priority) in program 01.</p>	<p>Setting range is from 48V to 61V. Increment of each click is 1V.</p> <p>SOC 30% (default for Lithium)</p> 	<p>If any types of lithium battery is selected in program 05, setting value will change to SOC automatically. Setting range is 10% to 100%.</p>
<p>16</p>	<p>Charger source priority: To configure charger source priority</p>	<p>If this inverter/charger is working in Line, Standby or Fault mode, charger source can be programmed as below:</p> <p>Solar first</p> 	<p>Solar energy will charge battery as first priority. Utility will charge battery only when solar energy is not available.</p>





16	Charger source priority: To configure charger source priority	Solar and Utility (default) 16  SNU	Solar energy and utility will charge battery at the same time.
		Only Solar 16  050	Solar energy will be the only charger source no matter utility is available or not.
		If this inverter/charger is working in Battery mode, only solar energy can charge battery. Solar energy will charge battery if it's available and sufficient.	
18	Alarm control	Alarm on (default) 18  607	Alarm off 18  60F
19	Auto return to default display screen	Return to default display screen (default) 19  ESP	If selected, display screen will automatically return to default display screen (Input voltage /output voltage) after 1 minute.
		Stay at latest screen 19  HEP	If selected, the display screen will stay at last screen user selected.
20	Backlight control	Backlight on (default) 20  L07	Backlight off 20  L0F



















22	Beeps while primary source is interrupted	Alarm on (default) 22 A0N	Alarm off 22 A0F
23	Overload bypass: When enabled, the unit will transfer to line mode if overload occurs in battery mode.	Bypass disable (default) 23 bYd	Bypass enable 23 bYE
25	Record Fault code	Record enable (default) 25 FEN	Record disable 25 FdS
26	Bulk charging voltage (C.V voltage)	default: 56.4V 26 CV BATT 56.4 <sub>v</sub>	If self-defined is selected in program 5, this program can be set up. Setting range is from 48.0V to 61.0V. Increment of each click is 0.1V.
27	Floating charging voltage	default: 54.0V 27 FLV BATT 54.0 <sub>v</sub>	If self-defined is selected in program 5, this program can be set up. Setting range is from 48.0V to 61.0V. Increment of each click is 0.1V.
28	AC output mode  <i>*This setting is only available when the inverter is in standby mode (power Switch in off position).</i>	Single: This inverter is used in single phase application. 28 S1G  When the inverter is operation in split phase application, set up inverter to be operated in specific phase.	Parallel: This inverter is operated in parallel system. 28 PARL

















28	<p>AC output mode</p> <p><i>*This setting is only available when the inverter is in standby mode (Switch off).</i></p>	<p>L1 phase:</p> <p>28 </p> <p>3P 1</p>	<p>L2 phase:</p> <p>28 </p> <p>3P 2</p>
		<p>L3 phase:</p> <p>28 </p> <p>3P 3</p>	
		<p>L1 for split phase:</p> <p>28 </p> <p>2P 1</p>	<p>L2 for split phase: (120° phase difference)</p> <p>28 </p> <p>120</p> <p>2P 2</p>
		<p>L2 for split phase: (180° phase difference)</p> <p>28 </p> <p>180</p> <p>2P 2</p>	
29	<p>Low DC cut-off voltage:</p> <ul style="list-style-type: none"> <li>● If battery power is only power source available, inverter will shut down.</li> <li>● If PV energy and battery power are available, inverter will charge battery without AC output.</li> <li>● If PV energy, battery power and utility are all available, inverter will transfer to line mode and provide output power to loads.</li> </ul>	<p>default: 44.0V</p> <p>29 </p> <p>COV</p> <p>BATT</p> <p>44.0V</p>	<p>If self-defined is selected in program 5, this program can be set up. Setting range is from 42.0V to 48.0V. Increment of each click is 0.1V. Low DC cut-off voltage will be fixed to setting value no matter what percentage of load is connected.</p>
		<p>SOC 0% (default for Lithium)</p> <p>29 </p> <p>SOC</p> <p>BATT</p> <p>0%</p>	<p>If any types of lithium battery is selected in program 05, setting value will change to SOC automatically. Adjustable range is 0% to 90%. Increment of each click is 5%.</p>
30	Battery equalization	<p>Battery equalization</p> <p>30 </p> <p>EEN</p>	<p>Battery equalization disable (default)</p> <p>30 </p> <p>EdS</p>

		If "Flooded" or "User-Defined" is selected in program 05, this program can be set up.	
31	Battery equalization voltage	default: 58.4V 31  EV BATT 58.4V	Setting range is from 48.0V to 62.0V. Increment of each click is 0.1V.
33	Battery equalized time	60min (default) 33  60	Setting range is from 5min to 900min. Increment of each click is 5min.
34	Battery equalized timeout	120min (default) 34  120	Setting range is from 5min to 900 min. Increment of each click is 5 min.
35	Equalization interval	30days (default) 35  30d	Setting range is from 0 to 90 days. Increment of each click is 1 day
36	Equalization activated immediately	Enable 36  AEN	Disable (default) 36  ADS
		If equalization function is enabled in program 30, this program can be set up. If "Enable" is selected in this program, it's to activate battery equalization immediately and LCD main page will show "E9". If "Disable" is selected, it will cancel equalization function until next activated equalization time arrives based on program 35 setting. At this time, "E9" will not be shown in LCD main page.	
37	Reset all stored data for PV generated power and output load energy	Not reset(Default) 37  N+L	Reset 37  RST

<p>41</p>	<p>Maximum discharging current</p>	<p>Disable (Default)</p> <p>41 </p> <p>dd5</p>	<p>If selected, battery discharge protection is disabled.</p>
		<p>30A</p> <p>41 </p> <p>30</p>	<p>The setting range is from 30 A to 150 A. Increment of each click is 10A.</p> <p>If discharging current is higher than setting value, battery will stop discharging. At this time, if the utility is available, the inverter will operate in bypass mode. If no utility is available, the inverter will shut down after 5-minute operation in battery mode.</p>
		<p>150A</p> <p>41 </p> <p>150</p>	
<p>42</p>	<p>Neutral-Ground Bond Enable/Disable</p>	<p>Enables neutral pass-through</p> <p>ENR</p> <p>42 </p>	<p>Disables neutral pass-through</p> <p>d15</p> <p>42 </p>

51	On/Off control for RGB LED *This setting must be enable to activate RGB LED lighting function.	Enabled (default) S1  LEN	Disable S1  Ld5
52	Brightness of RGB LED	Low S2  LO	Normal (default) S2  NOF
		High S2  HI	
53	Lighting speed of RGB LED	Low S3  LO	Normal (default) S3  NOF

		High 53  H1	
54	RGB LED effects	Scrolling 54  50f	Breathing 54  bfe
		Solid on (Default) 54  50L	
55	Color combination of RGB LED to show energy source and battery charge/discharge status: <ul style="list-style-type: none"> <li>● Grid-PV-Battery</li> <li>● Battery charge/discharge status</li> </ul>	C01: (Default) <ul style="list-style-type: none"> <li>● Violet-White-Sky blue</li> <li>● Pink-Honey</li> </ul> 55  C01	C02: <ul style="list-style-type: none"> <li>● White-Yellow-Green</li> <li>● Royal blue-Lime yellow</li> </ul> 55  C02
92	On/Off control for 12V DC output (For optional accessory)	Enable (default) 92  dce	Disable 92  dcd
93	Erase all data log	Not reset (Default) 93  nfe	Reset 93  fse



94	Data log recorded interval <i>*The maximum data log number is 1440. If it's over 1440, it will re-write the first log.</i>	3 minutes 94  3	5 minutes 94  5
		10 minutes (default) 94  10	20 minutes 94  20
		30 minutes 94  30	60 minutes 94  60
95	Time setting – Minute	For minute setting, the range is from 0 to 59. 95   mi n 0	
96	Time setting – Hour	For hour setting, the range is from 0 to 23. 96   HOU 0	
97	Time setting– Day	For day setting, the range is from 1 to 31. 97   DAY 1	
98	Time setting– Month	For month setting, the range is from 1 to 12. 98   MON 1	
99	Time setting – Year	For year setting, the range is from 17 to 99. 99   YEA 19	

### USB Function Settings

There are three function keys on the display panel to implement special functions such as USB OTG, timer setting for output source priority and timer setting for charger source priority.







#### 1. USB Function Setting

Insert an OTG USB disk into the USB port ( ). Press and hold " / " button for 3 seconds to enter USB setup mode. These functions include data log export and internal parameters re-write from the USB disk.

Procedure	LCD Screen
<b>Step 1:</b> Press and hold " / " button for 3 seconds to enter USB function setting mode.	UPG  
<b>Step 2:</b> Press " / ", " " or " " button to enter the selectable setting programs (detailed descriptions in Step 3).	SET LOG

**Step 3:** Please select setting program by following the procedure.

Program#	Operation Procedure	LCD Screen
----------	---------------------	------------

 Re-write internal parameters	This function is to over-write all parameter settings (TEXT file) with settings in the On-The-Go USB disk from a previous setup or to duplicate inverter settings. Please check with your dealer or installer for detail instructions.	
 Export data log	By pressing " " button to export data log from the inverter to USB disk. If the selected function is ready, LCD will display " LOG ". Press " / " button to confirm the selection again.	LOG    LOG
	<ul style="list-style-type: none"> <li>Press " " button to select "Yes", LED 1 will flash once every second during the process. It will only display LOG and all LEDs will be on after this action is complete. Then, press " / " button to return to main screen.</li> <li>Or press " " button to select "No" to return to main screen.</li> </ul>	LOG   YES NO

**NOTE:** If no button is pressed for 1 minute, it will automatically return to main screen.

#### Error message for USB On-the-Go functions:

Error Code	Messages
U01	No USB disk is detected.
U02	USB disk is protected from copy.
U03	Document inside the USB disk with wrong format.

**NOTE:** If any error occurs, error code will only show for 3 seconds. After 3 seconds, it will automatically return to display screen.



### 2. Timer Setting for Output Source Priority

This timer setting is to set up the output source priority per day.

Procedure	LCD Screen
<b>Step 1:</b> Press and hold "☰☒" button for 3 seconds to enter Timer Setup Mode for output source priority.	USB ⚙️
<b>Step 2:</b> Press "☰/☑", "☰☒" or "☰☑" button to enter the selectable programs (detail descriptions in Step 3).	SUB SBU

**Step 3:** Please select setting program by following each procedure.

Program#	Operation Procedure	LCD Screen
☰/☑	Press "☰/☑" button to set up Utility First Timer. Press "☰☒" button to select starting time. Press "▲" or "▼" button to adjust values and press "←" to confirm. Press "☰☑" button to select end time. Press "▲" or "▼" button to adjust values, press "←" button to confirm. The setting values are from 00 to 23, with 1-hour increment.	USB ⚙️ 00 23
☰☒	Press "☰☒" button to set up Solar First Timer. Press "☰☒" button to select starting time. Press "▲" or "▼" button to adjust values and press "←" to confirm. Press "☰☑" button to select end time. Press "▲" or "▼" button to adjust values, press "←" button to confirm. The setting values are from 00 to 23, with 1-hour increment.	SUB ⚙️ 00 23
☰☑	Press "☰☑" button to set up SBU Priority Timer. Press "☰☒" button to select starting time. Press "▲" or "▼" button to adjust values and press "←" to confirm. Press "☰☑" button to select end time. Press "▲" or "▼" button to adjust values, press "←" button to confirm. The setting values are from 00 to 23, with 1-hour increment.	SBU ⚙️ 00 23

Press "☰/☑" button to exit the Setup Mode.























### 3. Timer Setting for the Charger Source Priority

This timer setting is to set up the charger source priority per day.

Procedure	LCD Screen
<b>Step 1:</b> Press and hold "☰☑" button for 3 seconds to enter Timer Setup Mode for charging source priority.	CSO ⚙️
<b>Step 2:</b> Press "☰/☑", "☰☒" or "☰☑" button to enter the selectable programs (detail descriptions in Step 3).	SNU OSO

**Step 3:** Please select setting program by following each procedure.

Program#	Operation Procedure	LCD Screen
☰/☑	Press "☰/☑" button to set up Solar First Timer. Press "☰☒" button to select starting time. Press "▲" or "▼" button to adjust values and press "←" to confirm. Press "☰☑" button to select end time. Press "▲" or "▼" button to adjust values, press "←" button to confirm. The setting values are from 00 to 23, with 1-hour increment.	CSO ⚙️ 00 23

	<p>Press "" button to set up Solar &amp; Utility Timer. Press "" button to select starting time. Press "" or "" button to adjust values and press "" to confirm. Press "" button to select end time. Press "" or "" button to adjust values, press "" button to confirm. The setting values are from 00 to 23, with 1-hour increment.</p>	
	<p>Press "" button to set up Solar Only Timer. Press "" button to select starting time. Press "" or "" button to adjust values and press "" to confirm. Press "" button to select end time. Press "" or "" button to adjust values, press "" button to confirm. The setting values are from 00 to 23, with 1-hour increment.</p> <p>Press "/0" button to exit the Setup Mode.</p>	

## Commissioning - Battery Based

**Note:** Systems must be commissioned while connected to battery banks. PV or AC input only based commissioning is not recommended or supported.

### 120V Single Phase

Step 1: Check the following requirements before commissioning:

- Ensure all wire connections are correct.
- Ensure all breakers of the inputs and outputs are in the off position.

#### Display Code Reference:

Code	Description	Icon on
NE	Unidentified unit master or slave	NE
HS	Host unit	HS
SL	Slave unit	SL

Step 2: Power on external DC breaker between battery and inverter, if equipped. Provide power from the battery bank to the inverters and then power all inverters on (depress the power button), starting with the host.

Step 3: After the startup countdown, hold the enter "↵" button for 3 seconds to access the settings menu.

Step 4: Use the down arrow to go to program setting 28 (AC output mode).

Step 5: Place HOST or SLAVE inverter into standby mode (fully depress/release the power button - inverter screen will remain on).

Step 6: On the HOST or SLAVE inverter; press enter "↵" to access setting 28, program inverter to "PAL", press the enter button "↵" and press escape button "⏏" to save and exit. Power on the inverter to bring it out of standby mode (depress the power button). Repeat steps 3-6 to set each SLAVE inverter to "PAL" (If only using 1 inverter, program setting 28 to "SIG").

*Note: Step 6 must be completed within 25 seconds of entering standby mode. The system will shut down after the connected inverters are taken out of phase. This is a safety feature that ensures all AC output is correctly programmed. If completion in 25 seconds is not possible and the system shuts down, begin by restarting the last inverter which was successfully programmed and continue until all inverters have been setup correctly.*

Step 7: Turn off all battery breakers and inverters to power down system and ensure settings implementation.

Step 8: Power on external DC breaker between battery and inverter, if equipped. Provide power from the battery bank to the inverters.

Step 10: Switch on all AC in breakers.

Step 11: Ensure PV voltage meets specifications on page 15. Turn on PV power.

Step 12: Depress the power button on the inverter to power on unit.

Step 13: Switch on all AC out breakers.

**240V Split-phase**

Step 1: Check the following requirements before commissioning:

- Ensure all wire connections are correct.
- Ensure all breakers of the inputs and outputs are in the off position.

**Display Code Reference:**

Code	Description	Icon on
NE	Unidentified unit master or slave	NE
HS	Host unit	HS
SL	Slave unit	SL

Step 2: Power on external DC breaker between battery and inverter, if equipped. Provide power from the battery bank to the inverters and then power all inverters on (depress the power button), starting with the host.

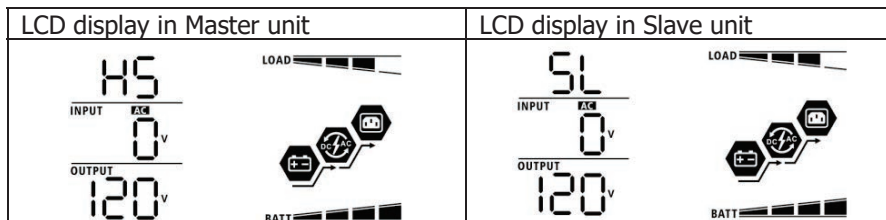

*Note: Master and slave units are randomly defined if units are powered on together. To define a host unit, start the unit you wish to be the host first.*

Step 3: After the startup countdown, hold the enter "↵" button for 3 seconds to access the settings menu.

Step 4: Use the down arrow to go to program setting 28 (AC output mode).

Step 5: Place HOST or SLAVE inverter into standby mode (fully depress/release the power button - inverter screen will remain on).

Steps 6: On your HOST inverter; press enter "↵" to access setting 28, program inverter to 2P1, press the enter button "↵" and press the escape "⏏" button to save and exit. Power on the inverter to bring it out of standby (depress the power button). Repeat steps 3-5 for first SLAVE inverter then move to step 7.

Step 7: On your SLAVE inverter; press enter "↵" to access setting 28, program inverter to 2P2 180, press the enter button "↵" and press the escape "⏏" button to save and exit. Power on the inverter to bring it out of standby (depress the power button). Repeat 3-7 for additional SLAVE units making sure L1 and L2 units are phased correctly.

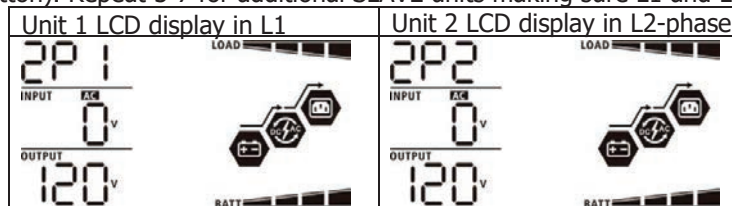

**Note:** Step 7 must be completed within 25 seconds of the end of step 5. The system will shut down after the connected inverters are taken out of phase. This is a safety feature that ensures all AC output is correctly programmed. If completion in 25 seconds is not possible and the system shuts down, begin by restarting the last inverter which was successfully programmed and continue until all inverters have been setup correctly.

Step 8: Once all inverters are set to the correct 2PX programming under setting 28, turn off all battery breakers and inverters to power down the system and ensure settings implementation.

Step 9: Power on external DC breaker between battery and inverter, if equipped. Provide power from the battery bank to the inverters.

Step 10: Switch on all AC in breakers. If a fault occurs, make sure L1 and L2 are phased correctly.

Step 11: Ensure PV voltage meets specifications on page 15. Turn on PV power.

Step 12: Depress the power button on the inverter to power on unit, starting with the host.

Step 13: Switch on all AC output breakers.

### 3-phase Commissioning:

Step 1: Check the following requirements before commissioning:

- Ensure all wire connections are correct.
- Ensure all breakers of the inputs and outputs are in the off position.

#### Display Code Reference:

Code	Description	Icon on
NE	Unidentified unit master or slave	NE
HS	Host unit	HS
SL	Slave unit	SL

Step 2: Power on external DC breaker between battery and inverter, if equipped. Provide power from the battery bank to the inverters and then power all inverters on (depress the power button) starting with the host.

Step 3: After the startup countdown hold the enter button "↵" button for 3 seconds to access the settings menu.

Step 4: Use the down arrow to go to program setting 28 (AC output mode).

Step 5: Place HOST or SLAVE inverter into standby mode (fully depress/release the power button - inverter screen will remain on).

Step 6: On the HOST inverter; press the enter button "↵" to access setting 28, program inverter to 3P1, press the enter button "↵" and press escape button "⏏" to save and exit. Power on the inverter to bring out of standby (depress the power button). Repeat steps 3-5 for SLAVE 1 inverter, then move to step 7.

Step 7: On SLAVE 1 inverter; press the enter button "↵" to access setting 28, program inverter to 3P2 120, press the enter button "↵" and press escape button "⏏" to save and exit. Power on the inverter to bring out of standby (depress the power button). Repeat steps 3-5 for SLAVE 2 inverter, then move to step 8.

Step 8: On SLAVE 2 inverter; press the enter button "↵" to access setting 28, program inverter to 3P3 120, press the enter button "↵" and press the escape button "⏏" to save and exit. Power on the inverter to bring out of standby (depress the power button). Repeat steps 3-8 for additional slave units making sure L1, L2, and L3 units are phased correctly.

**Note:** Step 7 and 8 must be completed within 25 seconds of the end of step 5. The system will shut down after the connected inverters are taken out of phase. This is a safety feature that ensures all AC output is correctly programmed. If completion in 25 seconds is not possible and the system shuts down, begin by restarting the last inverter which was successfully programmed and continue until all inverters have been setup correctly.

Step 9: Turn off all battery breakers and inverters to power down system and ensure settings implementation.

Step 10: Power on external DC breaker between battery and inverter, if equipped. Provide power from the battery bank to the inverters.

Step 11: Switch on all AC in breakers.

Step 12: Ensure PV voltage meets specifications on page 15. Turn on PV power.

Step 13: Power all inverters on (depress the power button), starting with the host. If fault 82 occurs, the inverters will automatically restart.

Step 13: Switch on all AC out breakers.

## Communications

### Serial to PC Connection

Please use the supplied serial cable for connection between the inverter and your PC. Install the monitoring software from the bundled CD and follow the on-screen instructions to complete your installation. For detailed software operation, refer to the software user manual on the bundled CD.

### Wi-Fi Connection to Internet

This unit is equipped with a Wi-Fi transmitter. The Wi-Fi transmitter can enable wireless communication between off-grid inverters and monitoring platform. Users can access and control the monitored inverter with downloaded APP. You can find the "WatchPower" app on the Apple® Store or "WatchPower Wi-Fi" in the Google® Play Store. All data loggers and parameters are saved in iCloud.



## CLEANING AND MAINTENANCE FOR ANTI-DUST KIT

### Overview

Every inverter comes with an installed anti-dust kit from the factory. The inverter will automatically detect this kit and activate an internal thermal sensor to adjust internal temperature, also keeping dust out of the inverter, increasing the product reliability and lifespan.

### Cleaning and Maintenance

**Step 1:** Loosen the screw in figure 1.

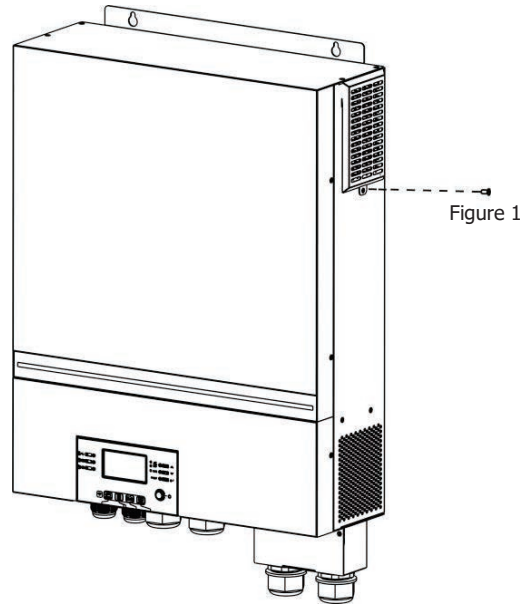

**Step 2:** Remove the cover and take out air filter foam as shown in the image below.

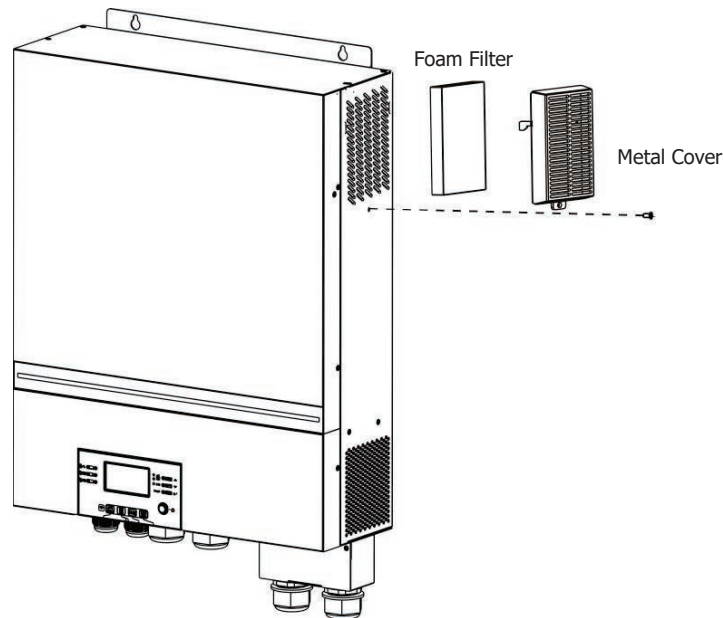

**Step 3:** Clean air filter foam and metal cover. After cleaning, re-assemble and install the dust-kit back in the inverter.

**Please Note:** The anti-dust kit should be cleaned monthly.



## TROUBLE SHOOTING

Problem	LCD/LED/Buzzer	Explanation / Possible cause	What to do
Unit shuts down automatically during startup process.	LCD/LEDs and buzzer will be active for 3 seconds and then complete off.	The battery voltage is too low (<1.91V/Cell)	1. Re-charge battery. 2. Replace battery.
No response after power on.	No indication.	1. The battery voltage is far too low. (<1.4V/Cell) 2. Battery polarity is reversed.	1. Check if batteries and the wiring are connected corrected and securely. 2. Re-charge battery.
Mains exist but the unit works in battery mode.	Input voltage is displayed as 0 on the LCD and green LED is flashing.	Input protector is tripped	Check if AC breaker is tripped and AC wiring is connected correctly.
	Green LED is flashing.	Insufficient quality of AC power. (Shore or Generator)	1. Check if AC wires are too thin and/or too long. 2. Check if generator (if applied) is working well or if input voltage range setting is correct. (UPS→Appliance)
	Green LED is flashing.	"Solar First" is set as the priority energy source for loads.	Change output source priority to Utility first.
When the unit is turned on, internal relay is switched on and off repeatedly.	LCD display and LEDs are flashing	Battery is disconnected.	Check if battery wires are connected well.
Buzzer beeps continuously and red LED is on.	Fault code 07	Overload error. The inverter is overload 110% and time is up.	Reduce the connected load by switching off some equipment.
	Fault code 05	Output short circuited.	Check if wiring is connected well and remove abnormal load.
		Temperature of internal converter component is over 120°C. (Only available for 1-3KVA models.)	Check whether the air flow of the unit is blocked or whether the ambient temperature is too high.
	Fault code 02	Internal temperature of inverter component is over 100°C.	
	Fault code 03	Battery is over-charged.	Return to repair center.
		The battery voltage is too high.	Check if spec and quantity of batteries meet minimum design requirements.
	Fault code 01	Fan fault	Replace the fan.
	Fault code 06/58	Output abnormal (Inverter voltage is below 190Vac or is higher than 260Vac)	1. Reduce the connected load. 2. Return to repair center
	Fault code 08/09/53/57	Internal components failed.	Return to repair center.
	Fault code 51	Over current or surge.	Check to ensure you are getting proper PV voltage to the inverter.
	Fault code 52	Bus voltage is too low.	
Fault code 55	Output voltage is unbalanced.		
Fault code 56	Battery is not connected well or fuse is burnt.	If the battery is connected well, please return to repair center.	

**Trouble shooting Cont.**







Situation		Solution
Fault Code	Fault Event Description	
60	Current feedback into the inverter is detected.	<ol style="list-style-type: none"> <li>1. Restart the inverter.</li> <li>2. Confirmed Line and Neutral wires are landed correctly.</li> <li>3. For parallel system in single phase, make sure the current sharing cables are connected for all on inverters on each phase. For supporting three-phase system, make sure the sharing cables are connected in the inverters in the same phase, and disconnected in the inverters in different phases.</li> <li>4. If the problem remains, please contact your retailer.</li> </ol>
71	The firmware version of each inverter is not the same.	<ol style="list-style-type: none"> <li>1. Update all inverter firmware to the same version.</li> <li>2. Check the version of each inverter via LCD setting and make sure the CPU versions are the same. If not, please contact your installer to provide the firmware to update.</li> <li>3. After updating, if the problem still remains, please contact your retailer.</li> </ol>
72	The output current of each inverter is different.	<ol style="list-style-type: none"> <li>1. Check if sharing cables are connected well and restart the inverter.</li> <li>2. If the problem remains, please contact your retailer.</li> </ol>
80	CAN data loss	<ol style="list-style-type: none"> <li>1. Check if communication cables are connected correctly and restart the inverter.</li> <li>2. If the problem remains, please contact your retailer.</li> </ol>
81	Host data loss	
82	Synchronization data loss	
83	The battery voltage of each inverter is not the same.	<ol style="list-style-type: none"> <li>1. Make sure all inverters share the same group of batteries.</li> <li>2. Remove all loads and disconnect AC input and PV input. Then, check battery voltage of all inverters. If the values from all inverters are close, please check if all battery cables are the same length and same material type. Otherwise, please contact your retailer to provide SOP to calibrate battery voltage of each inverter.</li> <li>3. If the problem still remains, please contact your retailer.</li> </ol>
84	AC input voltage and frequency are detected different.	<ol style="list-style-type: none"> <li>1. Check the utility wiring connection and restart the inverter.</li> <li>2. Make sure utility starts up at same time. If there are breakers installed between utility and inverters, please be sure all breakers can be turned on AC input at same time.</li> <li>3. If the problem remains, please contact your retailer.</li> </ol>
85	AC output current imbalance	<ol style="list-style-type: none"> <li>1. Restart the inverter.</li> <li>2. Remove some loads and re-check load information from LCD of inverters. If the values are different, please check if AC input and output cables are in the same length and material type.</li> <li>3. If the problem remains, please contact your retailer.</li> </ol>
86	AC output mode setting is different.	<ol style="list-style-type: none"> <li>1. Switch off the inverter and check LCD setting #28.</li> <li>2. For parallel system in single phase, ensure setting #28 is set to "PAL" For supporting split-phase system, ensure setting #28 is set to 2P1/2P2</li> <li>3. If the problem remains, please contact your retailer.</li> </ol>

## Appendix I: Fault & Warning Codes



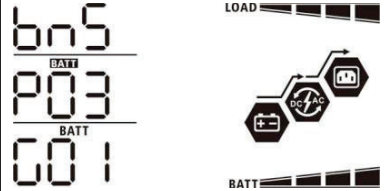









Fault Code	Fault Event	Icon on
01	Fan is locked when inverter is off.	F01
02	Over temperature	F02
03	Battery voltage is too high	F03
04	Battery voltage is too low	F04
05	Output short circuited.	F05
06	Output voltage is too high.	F06
07	Overload time out	F07
08	Bus voltage is too high	F08
09	Bus soft start failed	F09
10	PV over current	F10
11	PV over voltage	F11
12	DCDC over current	F12
13	Battery discharge over current	F13
51	Over current	F51
52	Bus voltage is too low	F52
53	Inverter soft start failed	F53
55	Over DC voltage in AC output	F55
57	Current sensor failed	F57
58	Output voltage is too low	F58
60	Power feedback protection	F60
71	Firmware version inconsistent	F71
72	Current sharing fault	F72
80	CAN fault	F80
81	Host loss	F81
82	Synchronization loss	F82
83	Battery voltage detected different	F83
84	AC input voltage and frequency detected different	F84
85	AC output current unbalance	F85
86	AC output mode setting is different	F86
90	EEPROM record data error	F90

**Code Reference -**

Related information code will be displayed on LCD screen. Please check inverter LCD screen for the operation.

Code	Description	Action
60 	If battery status is not allowed to charge and discharge after the communication between the inverter and battery is successful, it will show code 60 to stop charging and discharging battery.	
61 	<b>Battery Connection Lost</b> After battery is connected, communication signal is not detected for 3 minutes, buzzer will beep. After 10 minutes, inverter will stop charging and discharging to lithium battery. Communication lost occurs after the inverter and battery is connected successfully, buzzer beeps immediately.	Check battery communication cables for damage or improper connections. Confirm the pin-out of the cables is correct and there is no damage to the cable or port pins.
62 	Battery number is changed. It probably is because of communication lost between battery packs.	Press "UP" or "DOWN" key to switch LCD display until below screen shows. It will have battery number re-checked and 62 warning code will be clear. 
69 	The battery is unable to charge even with functional inverter to BMS communication. Likely cause is a cell or pack being in an over-voltage state.	Check the battery bank and each unit for status. If one battery has failed, see battery troubleshooting guide. Attempting to reboot the system with only the good batteries may restore some functionality.
70 	Battery charge has dropped to critical and this code indicates a failure to charge from the PV source when set to solar only. System will switch to AC source for charging.	Check the PV array at the disconnect after safely turning the strings off. Use a properly rate multimeter and see accredited PV string/array troubleshooting guides.
71 	If the battery is not able to discharge while communication is active/functioning, this code will indicate the issue. Example issue is a cell or pack voltage dropping below minimum.	Check the battery bank and each unit for status. If one battery has failed, see battery troubleshooting guide. Attempting to reboot the system with only the good batteries may restore some functionality.

## Warning Indicator

Warning Code	Warning Event	Audible Alarm	Icon flashing
01	Fan is locked when inverter is on.	Beep three times every second	01 
02	Over temperature	None	02 
03	Battery is over-charged	Beep once every second	03 
04	Low battery	Beep once every second	04 
07	Overload	Beep once every 0.5 second	07  
10	Output power derating	Beep twice every 3 seconds	10 
15	PV energy is low.	Beep twice every 3 seconds	15 
16	High AC input (>280VAC) during BUS soft start	None	16 
32	Communication failure between inverter and remote display panel	None	32 
E9	Battery equalization	None	E9 
bP	Battery is not connected	None	bP 

## LEAD BATTERY CHEMISTRY EQUALIZATION

The equalization function is added into charge controller. It reverses the buildup of negative chemical effects like stratification, a condition where acid concentration is greater at the bottom of the battery than at the top. Equalization also helps to remove sulfate crystals that might have built up on the plates. If left unchecked, this condition, called sulfation, will reduce the overall capacity of the battery. Therefore, it is recommended to equalize battery periodically.

### ● Starting Equalization

To start the battery equalization function in monitoring LCD setting, start by setting program to 33. Then, you may apply this function in device by either one of following methods:

1. Setting equalization interval in program 37.
2. Active equalization on demand using program 39.

### ● When to Equalize

In float stage, when the setting equalization interval (battery equalization cycle) has arrived, the equalization process is activated immediately, and the controller will enter Equalization stage.

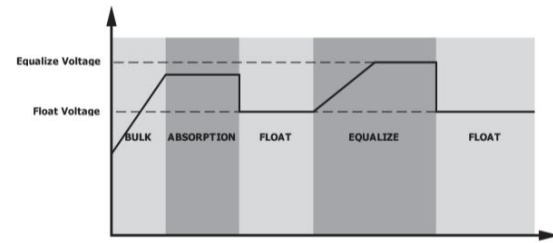

### ● Equalize charging time and timeout

In Equalize stage, the controller will supply power to charge the battery as much as possible until battery voltage raises to the battery equalization voltage. Then, a constant-voltage regulation is applied to maintain battery voltage at the required equalization voltage. The battery will remain in the Equalize stage until the battery equalize time setting has arrived.

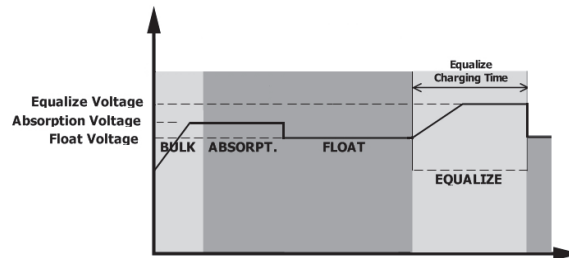

If the battery equalization time has expired while in the equalize stage, and battery voltage does not rise to the required equalization voltage point, the charge controller will extend the battery equalization time until battery voltage achieves battery equalization voltage. If battery voltage is still lower than battery equalization voltage when battery equalization timeout setting is over, the charge controller will stop equalization and return to float stage.

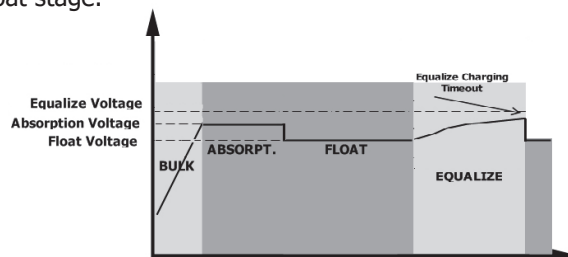

## Appendix II: Wi-Fi Operation Guide in Remote Panel

### 1. Introduction

Wi-Fi module can enable wireless communication between off-grid inverters and monitoring platform. Users have complete and remote monitoring and controlling experience for inverters when combining Wi-Fi module with WatchPower APP, available for both iOS and Android based device. All data loggers and parameters are saved in iCloud.

The major functions of this APP:

- Delivers device status during normal operation.
- Allows user to configure device setting after installation.
- Notifies users when a warning or alarm occurs.
- Allows users to query inverter history data.

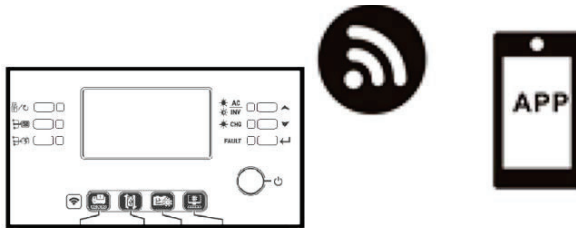

### 2. WatchPower App

#### 2-1. Download and install APP

***Operating system requirement for your smart phone:***

- 🍏 iOS system supports iOS 9.0 and above
- 🤖 Android system supports Android 5.0 and above

Please scan the following QR code with your smart phone and download WatchPower App.



**Android System**





**iOS System**



Or you may find "WatchPower" app on the Apple® Store or "WatchPower Wi-Fi" in the Google® Play Store.

#### 2-2. Initial Setup

Step 1: Registration at first time

After the installation, please tap the shortcut icon  to access this APP on your mobile screen. In the screen, tap "Register" to access "User Registration" page. Fill in all required information and scan the remote box PN by tapping  icon. Or you can simply enter PN directly. Then, tap "Register" button.

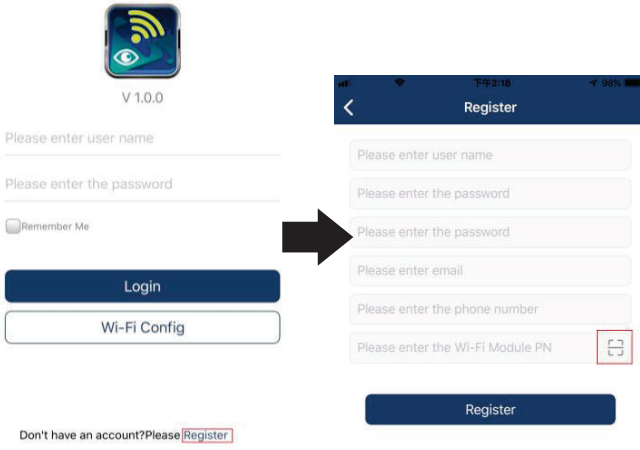

Then, a "Registration success" window will pop up. Tap "Go now" to continue setting local Wi-Fi network connection.

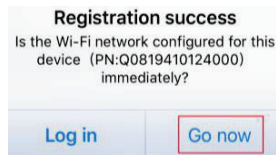

### Step 2: Local Wi-Fi Module Configuration

Now, you are in "Wi-Fi Config" page. There are detailed setup procedure listed in "How to connect?" section and you may follow it to connect Wi-Fi.

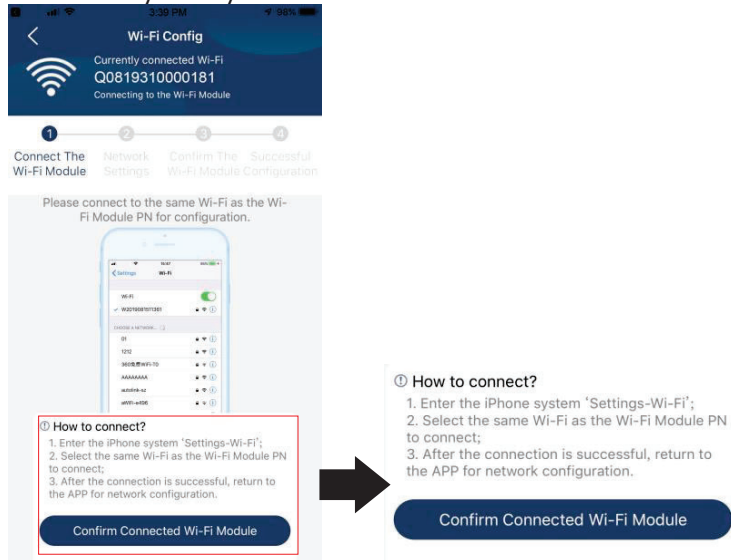

Enter the "Settings→Wi-Fi" and select connected Wi-Fi name. The connected Wi-Fi name is the same to your Wi-Fi PN number and enter default password "12345678".

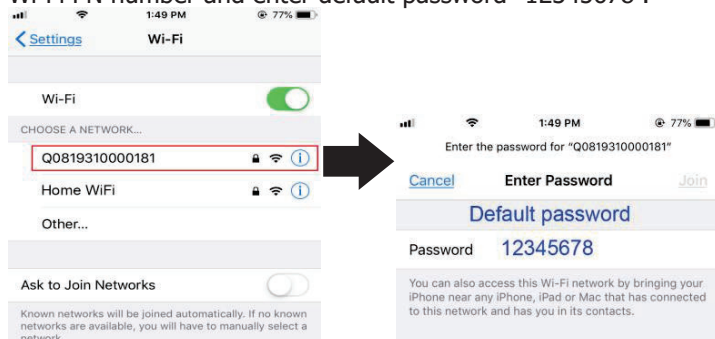

Then, return to WatchPower APP and tap "Confirm Connected Wi-Fi Module" button when Wi-Fi module is connected successfully.



Step 3: Wi-Fi Network settings

Tap  icon to select your local Wi-Fi router name (to access the internet) and enter password.

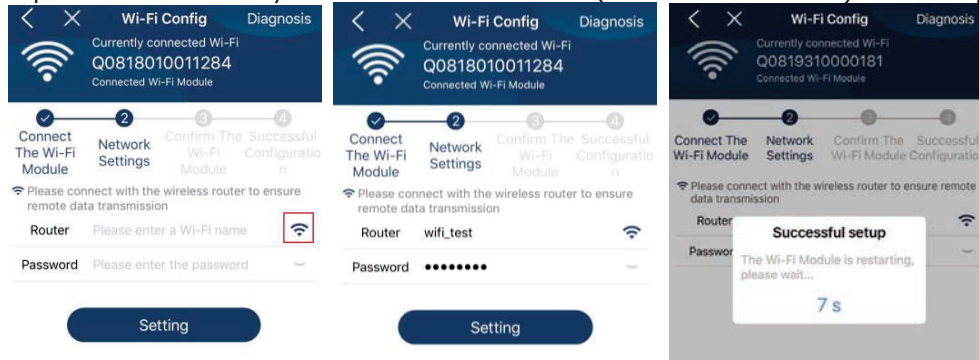

Step 4: Tap "Confirm" to complete the Wi-Fi configuration between the Wi-Fi module and the Internet.

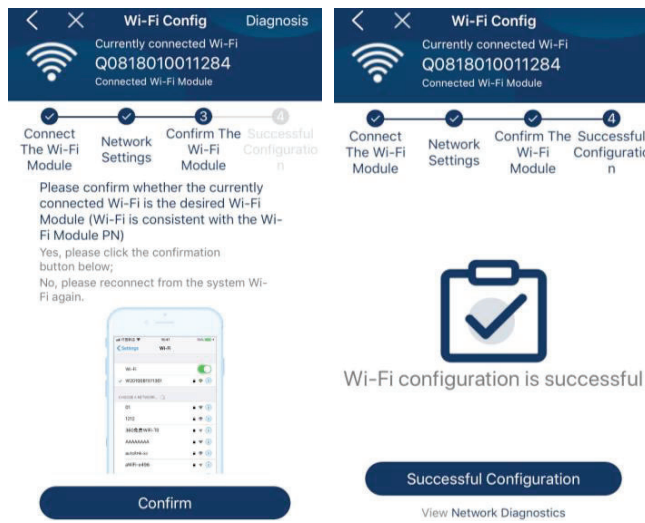

If the connection fails, please repeat Step 2 and 3.

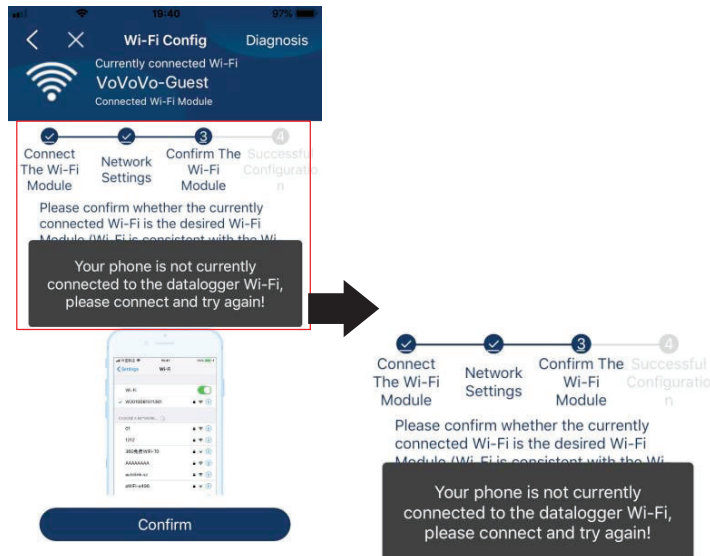

Diagnose Function

If the module is not monitoring properly, please tap "Diagnosis" on the top right corner of the screen for further details. It will show repair suggestion. Please follow it to fix the problem. Then, repeat the steps in the chapter 4.2 to re-set network setting. After all setting, tap "Rediagnosis" to re-connect again.

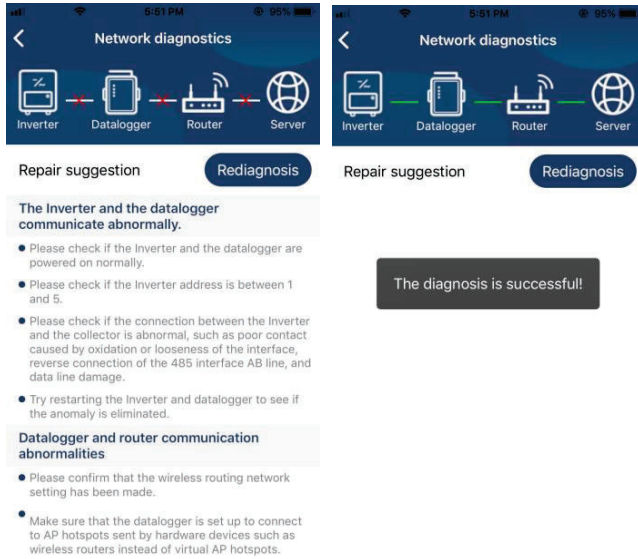

### 2-3.Login and APP Main Function

After finishing the registration and local Wi-Fi configuration, enter registered name and password to login.

**Note:** Tick "Remember Me" for your login convenience afterwards.

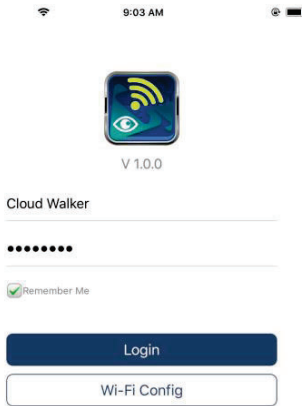

### Overview

After login is successfully, you can access "Overview" page to have overview of your monitoring devices, including overall operation situation and Energy information for Current power and Today power as below diagram.

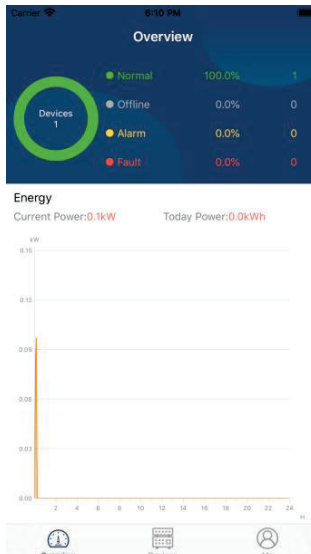

Devices

Tap the  icon (located on the bottom) to enter Device List page. You can review all devices here by adding or deleting Wi-Fi Modules in this page.

**Add device**



**Delete device**

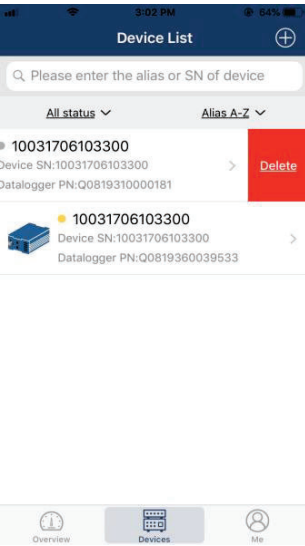

Tap the  icon on the top right corner and manually enter part number to add device. This part number label is pasted on the bottom of remote LCD panel. After entering part number, tap "Confirm" to add this device in the Device list.

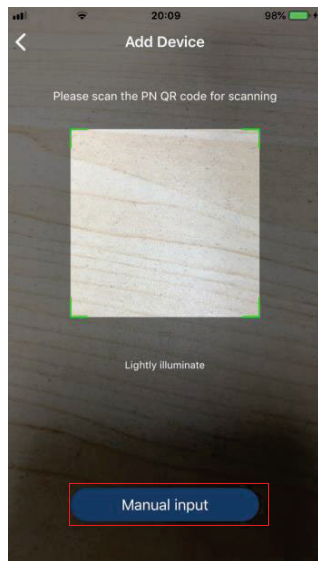

Part number label is pasted on the bottom of remote LCD panel.

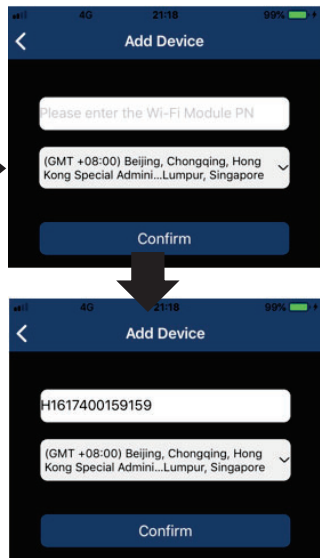

For more information about Device List, please refer to the section 2.4.

**ME**

In ME page, users can modify "My information", including **【User's Photo】** , **【Account security】** , **【Modify password】** , **【Clear cache】** ,and **【Log-out】** , shown as below diagrams.

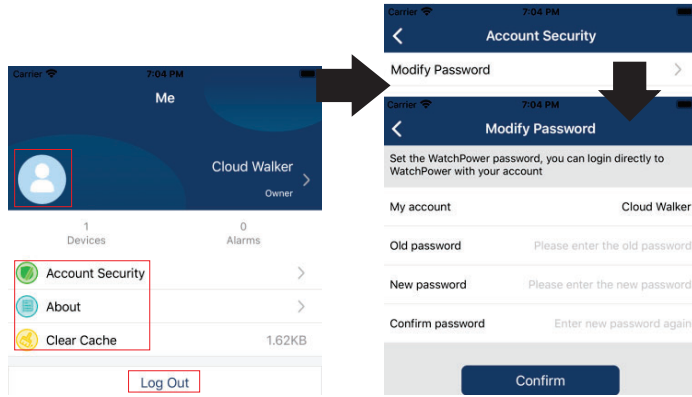

**2-4. Device List**

In the Device List page, you can pull down to refresh the device information and then tap any device you want to check up for its real-time status and related information as well as to change parameter settings. Please refer to the parameter setting list.

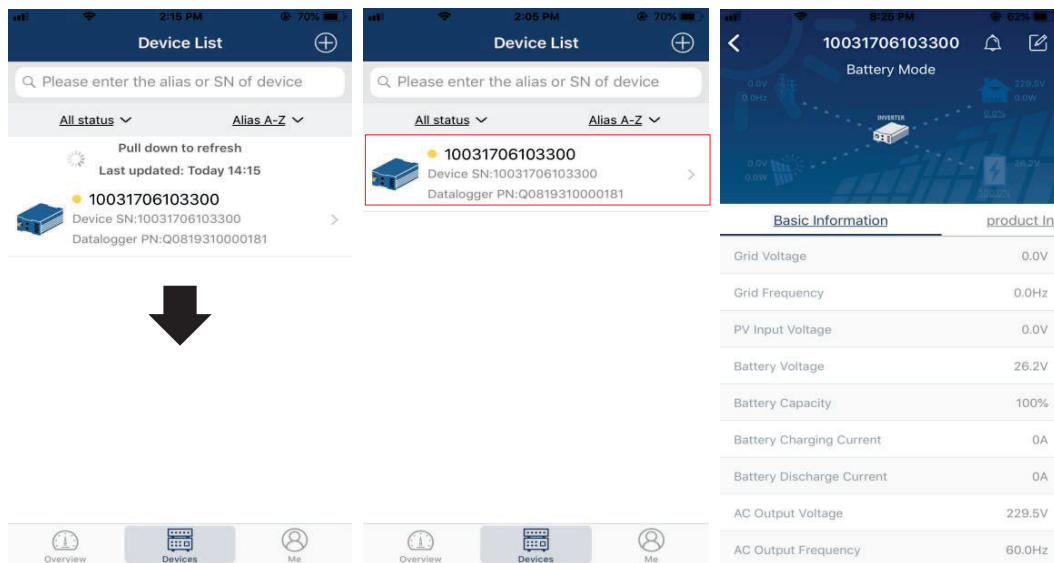

**Device Mode**

On the top of screen, there is a dynamic power flow chart to show live operation. It contains five icons to present PV power, inverter, load, utility and battery. Based on your inverter model status, there will be **【Standby Mode】** , **【Line Mode】** , **【Battery Mode】** .

**【Standby Mode】** Inverter will not power the load until "ON" switch is pressed. Qualified utility or PV source can charge battery in standby mode.

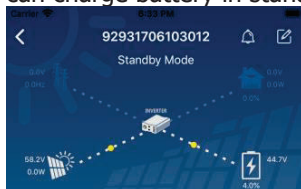

**【Line Mode】** Inverter will power the load from the utility with or without PV charging. Qualified utility or PV source can charge battery.

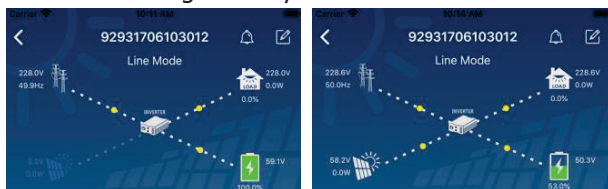

**[Battery Mode]** Inverter will power the load from the batter with or without PV charging. Only PV source can charge battery.

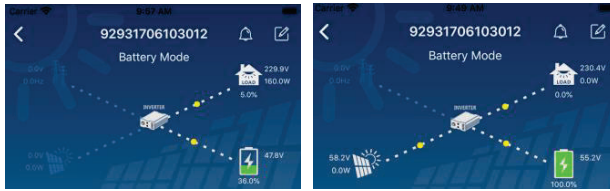

**Device Alarm and Name Modification**

In this page, tap the  icon on the top right corner to enter the device alarm page. Then, you can review alarm history and detailed information. Tap the  icon on the top right corner, a blank input box will pop out. Then, you can edit the name for your device and tap "Confirm" to complete name modification.

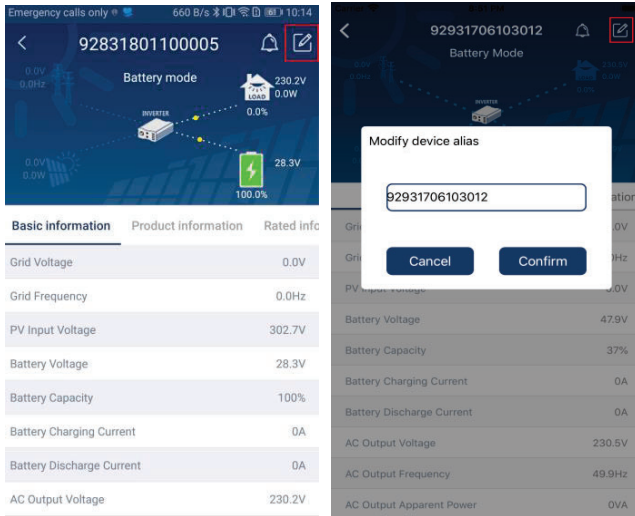

**Device Information Data**

Users can check up **[Basic Information]** , **[Product Information]** , **[Rated information]** , **[History]** , and **[Wi-Fi Module Information]** by swiping left.

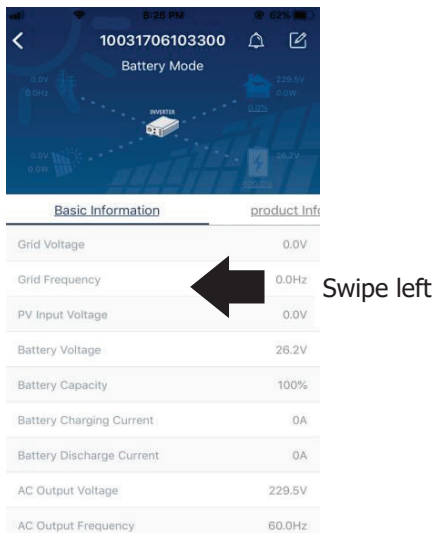

**[Basic Information]** displays basic information of the inverter, including AC voltage, AC frequency, PV input voltage, Battery voltage, Battery capacity, Charging current, Output voltage, Output frequency, Output apparent power, Output active power and Load percent. Please slide up to see more basic information.

**[Production Information]** displays Model type (Inverter type), Main CPU version, Bluetooth CPU version and secondary CPU version.

**【Rated Information】** displays information of Nominal AC voltage, Nominal AC current, Rated battery voltage, Nominal output voltage, Nominal output frequency, Nominal output current, Nominal output apparent power and Nominal output active power. Please slide up to see more rated information.

**【History】** displays the record of unit information and setting timely.

**【Wi-Fi Module Information】** displays the Wi-Fi Module PN, status and firmware version.

**Parameter Setting**

This page is to activate some features and set up parameters for inverters. Please note that the listing in "Parameter Setting" page in below diagram may differ from the models of monitored inverter. Here we will briefly highlight some of it, **【Output Setting】** , **【Battery Parameter Setting】** , **【Enable/ Disable items】** , **【Restore to the defaults】** to illustrate.

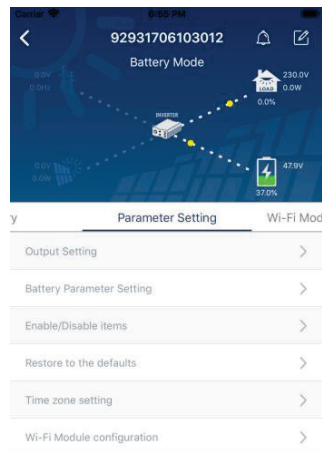

There are three ways to modify setting and they vary according to each parameter.

- a) Listing options to change values by tapping one of it.
- b) Activate/Shut down functions by clicking the "Enable" or "Disable" button.
- c) Changing values by clicking arrows or entering the numbers directly in the column. Each function setting is saved by clicking "Set" button.

Please refer to below parameter setting list for an overall description and be noted that the available parameters may vary depending on different models. Please always see the original product manual for detailed setting instructions.

**Parameter setting list:**

Item		Description
Output setting	Output source priority	To configure load power source priority.
	AC input range	When selecting "UPS", it's allowed to connect personal computer. Please check product manual for details.
		When selecting "Appliance", it's allowed to connect home appliances.
	Output voltage	Set the output voltage.
	Output frequency	Set the output frequency.
Battery parameter setting	Battery type:	Set the connected battery type.
	Battery cut-off voltage	Sets the voltage at which the battery stops. Please see product manual for the recommended voltage range based on connected battery type.
	Back to grid voltage	When "SBU" or "SOL" is set as output source priority and battery voltage is lower than this setting voltage, unit will transfer to line mode and the grid will provide power to load.
	Back to discharge voltage	When "SBU" or "SOL" is set as output source priority and battery voltage is higher than this setting voltage, battery will be allowed to discharge.



Battery parameter setting (cont.)	Charger source priority:	To configure charger source priority.
	Max. charging current	It's to set up battery charging parameters. The selectable values in different inverter model may vary. Please see product manual for the details.
	Max. AC charging current:	
	Float charging voltage	
	Bulk charging voltage	It's to set up battery charging parameters. The selectable values in different inverter model may vary. Please see product manual for the details.
	Battery equalization	Enable or disable battery equalization function.
	Real-time Activate Battery Equalization	It's real-time action to activate battery equalization.
	Equalized Time Out	To set up the duration time for battery equalization.
	Equalized Time	To set up the extended time to continue battery equalization.
	Equalization Period	To set up the frequency for battery equalization.
	Equalization Voltage	To set up the battery equalization voltage.
	Enable/Disable Functions	LCD Auto-return to Main screen
Fault Code Record		If enabled, fault code will be recorded in the inverter when any fault happens.
Backlight		If disabled, LCD backlight will be off when panel button is not operated for 1 minute.
Bypass Function		If enabled, unit will transfer to line mode when overload happened in battery mode.
Beeps while primary source interrupt		If enabled, buzzer will alarm when primary source is abnormal.
Over Temperature Auto Restart		If disabled, the unit won't be restarted after over-temperature fault is solved.
Overload Auto Restart		If disabled, the unit won't be restarted after overload occurs.
Buzzer		If disabled, buzzer won't be on when an alarm/fault occurs.
RGB LED Setting	Enable/disable	Turn on or off RGB LEDs
	Brightness	Adjust the lighting brightness
	Speed	Adjust the lighting speed
	Effects	Change the light effects
	Color selection	Adjust color combination to show energy source an battery status
Restore to the default	This function is to restore all settings back to default settings.	

Appendix III:

# Certificate



Certificate no.

CU 72225980 01

License Holder:

EG4 Electronics LLC  
1130 Como Street South  
Sulphur Springs, TX 75482  
USA

Manufacturing Plant:

--CN209A02 005

Test report no.: USA- CN209A02 010

Client Reference: 238057504/KK290322

Tested to: UL 1741:2010 R2.18  
CSA C22.2 No. 107.1-16

Certified Product: Stand-alone Inverter

License Fee - Units

Model Designation: EG4-6500EX-48

Rating details : see Appendix  
Protection Class : I  
Rated Ambient Temperature: -10 to +40°C

Licensed Test mark:



Date of Issue  
(day/mo/yr)  
26/04/2022

TUV Rheinland of North America, Inc., 295 Foster Street, Suite 100, Littleton, MA 01460, Tel +1 (978) 266 9500, FAX + 1 (978) 266-9992





TÜV Rheinland Group

Appendix to TÜV approved Certificate No.: CU 72225980 01

Certified Product : Stand-alone Inverter  
 Report Number : CN209AO2 010  
 Type Designation: EG4-6500EX-48

Model Rating details:

DC Nominal Voltage .....	48V (Bat) 223V (Solar)
DC Operating range .....	90 ~ 500V (Solar)
MPPT DC Voltage range .....	90 ~ 450V (Solar)
DC Max. Current .....	153.8A (Bat) 18A x 2 (Solar)
Max. DC Short Circuit Current .....	PV Isc 22.5A x 2
AC Nominal Voltage .....	120 Vac
AC Operating range .....	120 Vac
Grid connection type .....	Single phase, L/N/PE
AC Max. Current .....	54.2A
Max. Output Overcurrent Protection .....	125A
AC Max. Continuous output Power .....	6500W.6500VA
Grid Frequency .....	60 Hz
Adjustable Voltage Frequency.....	60 Hz

Date: 26 Apr., 2022

Certification Body

2022.04.26  
09:01:52 +08'00'