

USER MANUAL

EG4 3000 EHV-48
SOLAR INVERTER/CHARGER
3KVA 120Vac

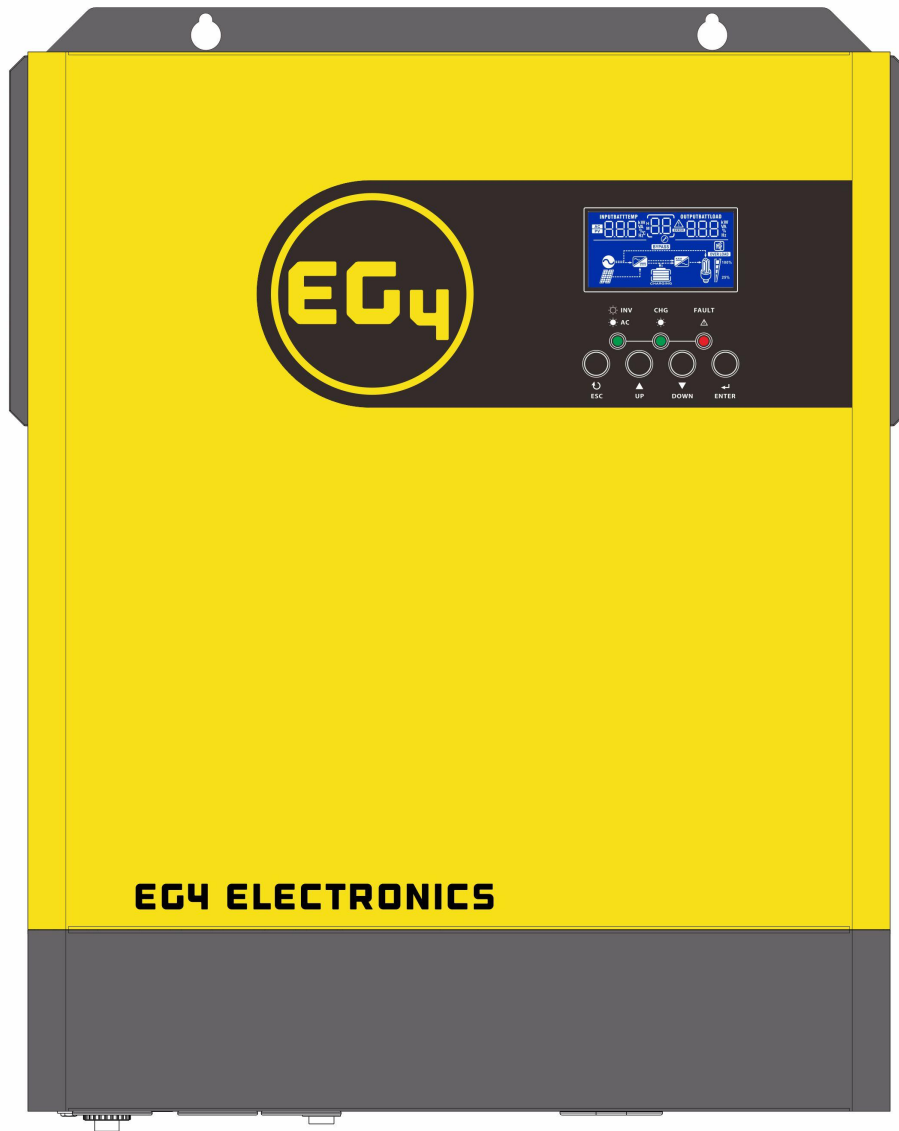

Table Of Contents

ABOUT THIS MANUAL	1
Purpose.....	1
Scope.....	1
SAFETY INSTRUCTIONS	1
SPECIFICATIONS	2
INTRODUCTION	6
Product Overview.....	7
INSTALLATION	8
Unpacking and Inspection.....	8
Preparation.....	8
Mounting the Unit.....	8
Battery Connection.....	9
AC Input/Output Connection.....	10
PV Connection.....	12
Final Assembly.....	13
Dry Contact Signal.....	14
OPERATION	15
Power ON/OFF.....	15
Operation of Display Panel.....	15
LCD Display Icons.....	16
Program Setting.....	18
Display Setting.....	26
Operating Mode Description.....	30
Typical Application.....	32
Parallel Installation Guide	33
1. Instruction.....	33
2. Package Contents.....	33
3. Mounting the Unit.....	33
4. Wiring Connection.....	34
5. Parallel Operation in Single phase.....	36
6. Support 3-phase equipment.....	39
7. Support split phase.....	41
8. PV Connection.....	42
9. Split-Phase and 3 Phase LCD Setting and Display.....	43
Commissioning	45
LITHIUM BATTERY SETTINGS	50
TROUBLE SHOOTING	55

ABOUT THIS MANUAL

Purpose

This manual describes the assembly, installation, operation and troubleshooting of this unit. Please read this manual carefully before installation and operation.

Scope

This manual provides safety and installation guidelines as well as information on tools and wiring.

SAFETY NOTICE

⚠ ATTENTION: The following contains important safety and operating instructions. Read and keep this manual for future reference.

1. Before installing or using the unit, read all instructions and cautionary markings on the unit, the batteries, and all appropriate sections of the manual.
2. **CAUTION-** Do not disassemble the unit. Take it to a qualified service center when service or repair is required. Incorrect re-assembly may result in a risk of electric shock or fire.
3. To reduce risk of electric shock, shutdown and disconnect all wirings before attempting any maintenance or cleaning. Turning off the unit alone will not reduce the risk of shock or injury.
4. **CAUTION** – Only qualified personnel can install this equipment.
5. **NEVER** charge a battery below specified minimum temperature; refer to the battery data sheet.
6. Wire size is critical for safe operation, and optimal performance of the equipment. Refer to a accredited sizing resource or cable manufacturer specifications to meet inverter/charge requirements.
7. Use caution when working with metal tools on or around all systems and batteries. Risk of electrical arcs and/or short circuiting of equipment can lead to severe injury and damage.
8. Strictly follow installation procedure when connecting and disconnecting AC or DC terminals. Refer to INSTALLATION section of the manual for details.
9. Install the provided over current protection device(s) between batteries and inverters.
10. **GROUNDING** -This inverter/charger should be connected to a permanent grounded wiring system. The grounding system must meet the Authority Having Jurisdiction (AHJ) requirements in your area.
11. **NEVER** short AC output and DC inputs. Do NOT connect to the grid with a shorted DC input.
12. **Warning!!** Only qualified service persons are able to service this device. If errors still persist after following troubleshooting table, please contact your retailer for further assistance.
13. **CAUTION:** DC breakers and surge protection on PV lines is recommended. Without breakers the equipment is at higher risk of damage from sources such as surges and lightning strikes.

DISCLAIMER

EG4 reserves the right to make changes to the material herein at any time without notice. You may refer to the EG4 website at www.eg4electronics.com for the most updated version of our manual.

SPECIFICATIONS

Table 1 Line Mode Specifications

INVERTER MODEL	3000EHV-48
Input Voltage Waveform	Sinusoidal (utility or generator)
Nominal Input Voltage	120Vac
Low Loss Voltage	95Vac± 7V (UPS) 65Vac± 7V (Appliances)
Low Loss Return Voltage	100Vac± 7V (UPS); 70Vac± 7V (Appliances)
High Loss Voltage	140Vac± 7V
High Loss Return Voltage	135Vac± 7V
Max AC Input Voltage	150Vac
Min AC Input Voltage	Electronics: 95 - 140VAC Home Appliances: 65 - 140VAC
Nominal Input Frequency	50Hz / 60Hz (Auto detection)
Low Loss Frequency	40± 1Hz
Low Loss Return Frequency	42± 1Hz
High Loss Frequency	65± 1Hz
High Loss Return Frequency	63± 1Hz
Output Short Circuit Protection	Line mode: Circuit Breaker 30A Battery mode: Solid State FETs 400A
Efficiency (Line Mode)	≈95% (Rated R load, battery full charged)
Transfer Time	10ms typical (UPS); 20ms typical (Appliances)
Output power derating: When AC input voltage drops to 95V, the output power will be derated.	

Table 2 Inverter Mode Specifications

INVERTER MODEL	3000EHV-48
Rated Output Power	3KVA/3KW
Output Voltage Waveform	Pure Sine Wave
Output Voltage Regulation	110/120Vac±5%
Output Frequency	60Hz or 50Hz
Battery to Inverter Efficiency	94%
PV to Inverter Efficiency	97%
Overload Protection	5s@≥150% load; 10s@110%~150% load
Surge Capacity	2 X rated power for 5 seconds
Nominal DC Input Voltage	48Vdc
MPPT Startup Voltage	120Vdc
Low DC Warning Voltage @ load < 20% @ 20% ≤ load < 50% @ load ≥ 50%	44.0Vdc 42.8Vdc 40.4Vdc
Low DC Warning Return Voltage @ load < 20% @ 20% ≤ load < 50% @ load ≥ 50%	46.0Vdc 44.8Vdc 42.4Vdc
Low DC Cut-off Voltage @ load < 20% @ 20% ≤ load < 50% @ load ≥ 50%	42.0Vdc 40.8Vdc 38.4Vdc

Table 3 Charge Mode Specifications

Utility Charging Mode		
INVERTER MODEL	3000EHV-48	
Charging Current (AC)	60Amp (@ $V_{I/P}=120\text{Vac}$)	
Charging Current (PV+AC)	80Amp (@ $V_{I/P}=120\text{Vac}$)	
Bulk Charging Voltage	Flooded Battery	58.4 Vdc
	AGM / Gel Battery	56.4 Vdc
Floating Charging Voltage	54Vdc	
Overcharge Protection	63Vdc	
Charging Algorithm	3-Step	

Charging Curve	
Solar Input	
INVERTER MODEL	3000EHV-48
Rated Power	5000W
Max. PV Array Open Circuit Voltage	500Vdc
PV Array MPPT Voltage Range	120Vdc~450Vdc
Max. Current Draw	18A
Number of MPPT	1
Start Up Voltage	42 VDC
Max Charging Current(PV)	80A

Table 4 General Specifications

INVERTER MODEL	3000EHV-48
Safety Certification	CE
Operating Temperature Range	-10°C to 55°C (14°C to 131°F)
Storage temperature	-15°C~ 60°C (5°C to 140°F)
Humidity	5% to 95% Relative Humidity (Non-condensing)
Dimension (D*W*H)	420mm x 340mm x 142mm 16.5" x 13.4" x 5.6"
Net Weight, kg/lb	10.5(13.1) 23.1lb(28.9)
USB	No USB Port
RS-232	YES
RS-485	Yes/ USB Type A
Dry Contact	Yes
Operating Altitude	0~1500m
Idle Power Consumption	<50W, <15W (Saving Mode)
IP Rating	IP 21 (Indoor Use)
Warranty	3 Years

Table 5 Parallel Specifications

INVERTER MODEL	3000EHV-48
Maximum Units in Parallel	12
Circulation Current (No Load)	<2A
Power Imbalance Ratio	<5%
Parallel Communication	CAN
Transfer Time in Parallel Mode	<20ms
Parallel Kit	Built In (RJ45 Port)

INTRODUCTION

This is a multi-function inverter/charger, combining the capabilities of an inverter, MPPT solar charger, and battery charger to offer uninterrupted power support in a portable size. Its comprehensive LCD display offers user-configurable and easy-accessible button operation including: battery charging current, AC/solar charger priority, and acceptable input voltage based on different applications.

Features

- Pure sine wave inverter - <3% THD
- Built-in MPPT solar controller - 120V to 500V
- Configurable input voltage range for home appliances and personal computers - 65V to 140VAC
- Configurable battery charging current based on applications - 10A to 80A
- Configurable AC/Solar Charger priority.
- Compatible to utility grid or generator power - 120V
- Auto restart when AC input is restored
- Overload/ Over temperature/ Short circuit protection
- Smart battery charger design for optimized battery performance

Basic System Architecture

The following illustration shows basic application for this inverter/charger - including the below-listed devices needed for a complete running system:

- Utility or Generator
- 48V Battery
- PV Modules

Consult with your system integrator for other possible system architectures depending on your requirements.

This inverter can power all kinds of appliances in a home or office environment, including compressor based appliances such as a refrigerator or air conditioner.

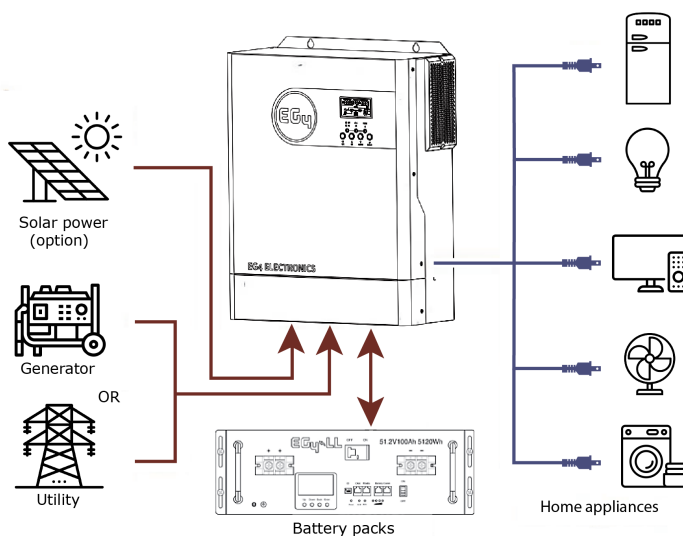
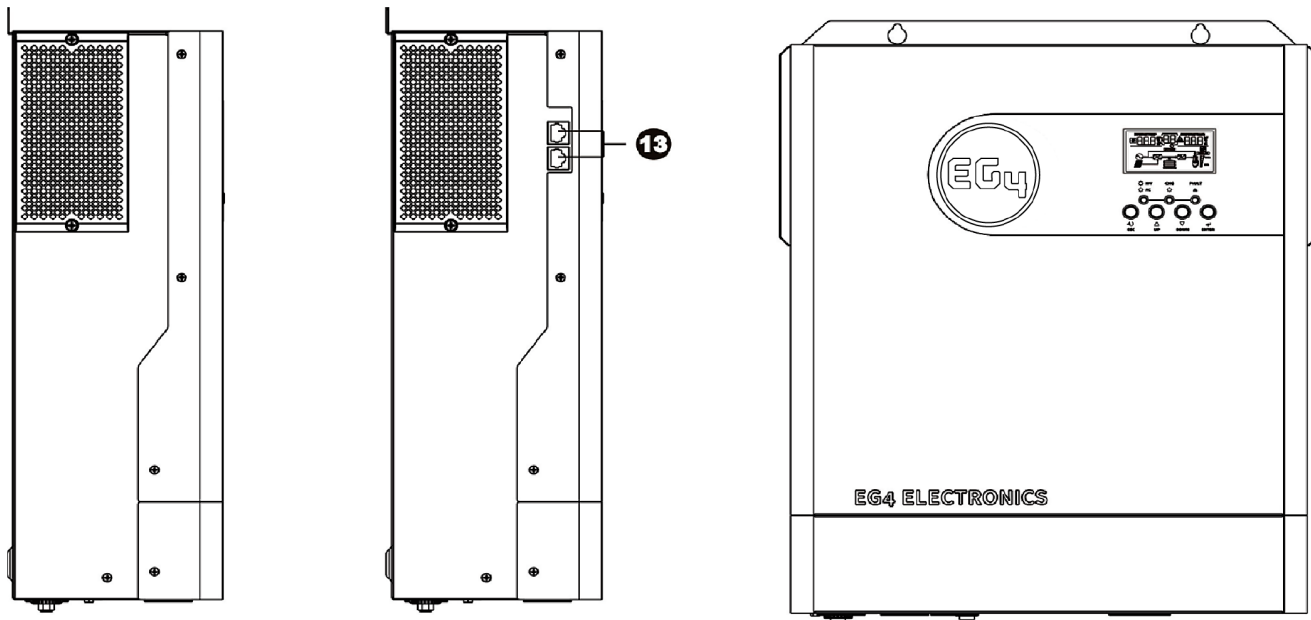
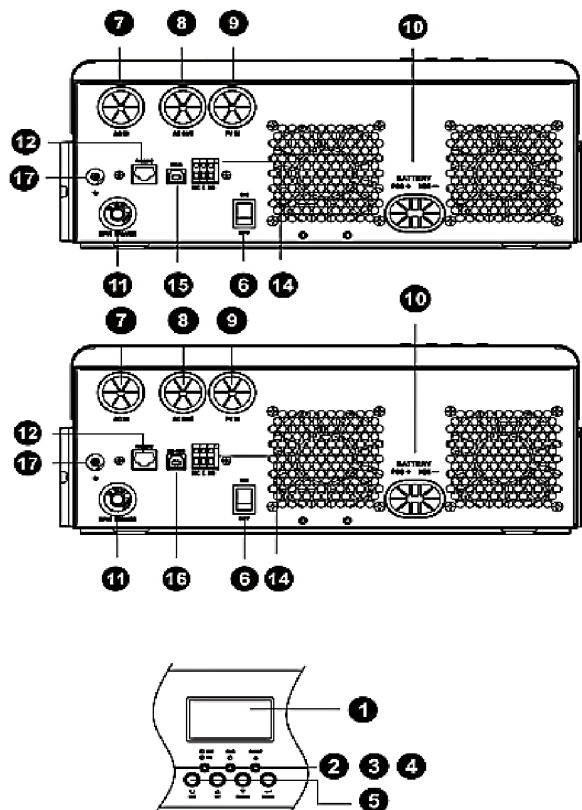

Figure 1 Solar Power System

Product Overview



1. LCD display
2. Status indicator
3. Charging indicator
4. Fault indicator
5. Function buttons
6. Power on/off switch
7. AC input (L - N)
8. AC output (L - N)
9. PV input (500Vdc Max)
10. Battery input (48V Nominal)
11. AC Input Circuit breaker
12. RS232 communication port for WiFi communication
13. Parallel communication port (only for parallel model)
14. Dry contact (Optional)
15. USB communication port for PC Applications
16. RS485 BMS communication port
17. Grounding Screw



INSTALLATION

Unpacking and Inspection

Before installation, please inspect the unit to be sure that nothing inside the package is damaged. You should have received the following items:

- EG4 3000EHV-48 Inverter
- User manual
- Battery BMS Cable
- 125A DC Breaker
- 6" DIN Rail
- 6' Red and Black 4AWG Battery Cable
- WiFi Communications Module
- 5' RJ11 to DB9 male RS232 Cable
- 4' RJ45 patch Cable
- 3' RS485 to USB Upgrade Cable

Preparation

Before connecting all wiring, please remove the bottom cover by removing two screws as shown below.

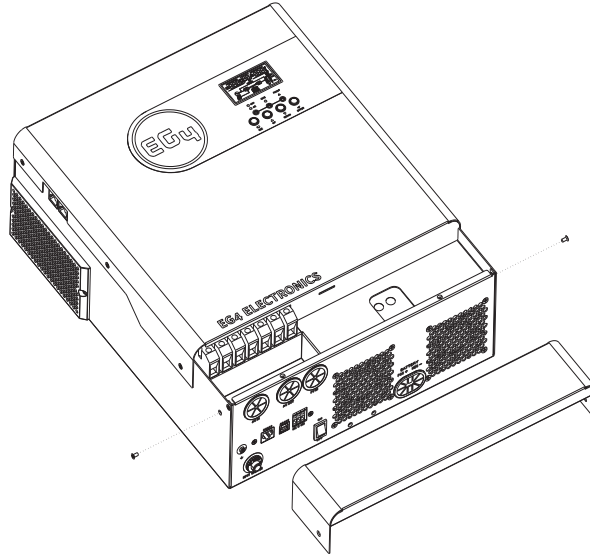

Mounting the Unit

Consider the following points before selecting where to install:

- Do not mount the inverter on flammable construction materials.
- Mount on a solid surface
- Install this inverter at eye level in order to allow the LCD display to be read at all times.
- The ambient temperature should be between 0°C to 55°C (-15°F to 131°F) to ensure optimal operation.
- The recommended installation position is to be adhered to the wall vertically.
- Be sure to distance other objects and surfaces as shown in the right diagram to guarantee sufficient heat dissipation and to have enough space for removing wires.

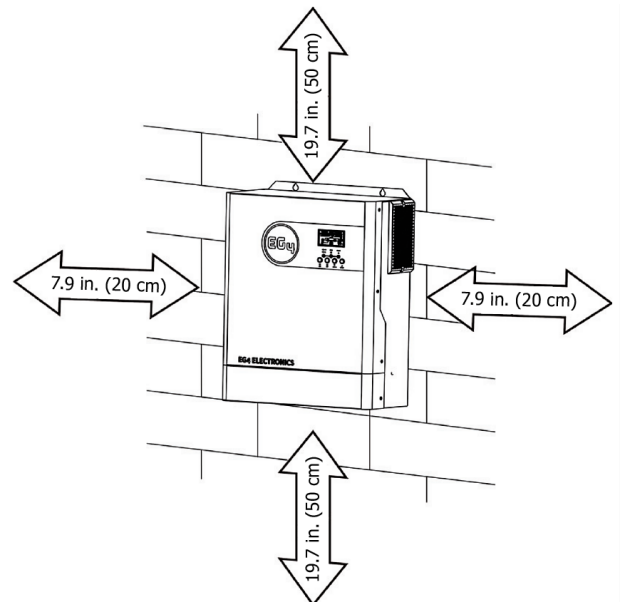

SUITABLE FOR INDOOR MOUNTING ON CONCRETE OR OTHER NON-COMBUSTIBLE SURFACE ONLY.

Install the unit by screwing three screws. It's recommended to use M4 or M5 screws.

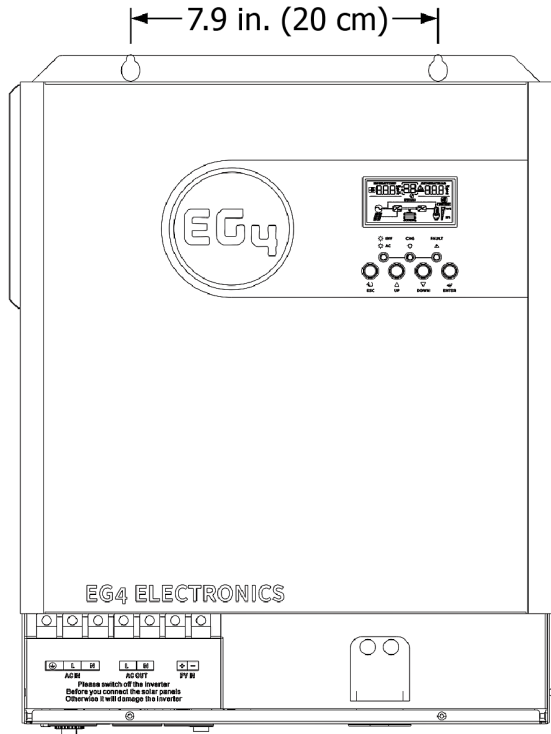

Battery Connection

CAUTION: For safe operation and regulation compliance, it is recommended that a separate DC over-current protector or disconnect device is installed between battery and inverter. Please refer to typical amperage listed below for required fuse or breaker size.

WARNING! We recommend all wiring be performed by a licensed professional.

WARNING! It is very important for system safety and efficient operation to use the appropriate cable size for battery connection. To reduce risk of injury, please use the recommended cable, stripping length(L2), and tinning length(L1) in the table below.

Stripping Length:

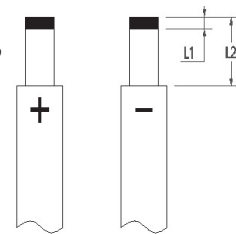

Recommended battery cable, stripping length (L2), and tinning length(L1):

Model	Maximum Amperage	Battery capacity	Wire Size AWG/mm ²	Recommended Wire Length	L1 (mm/in)	L 2 (mm/in)	Torque value
3000EHV-48	80A	100AH	4AWG/25	6'/1.8m up to 15'/4.6m	3/0.1"	18/0.7"	2~ 3 Nm

Please follow the following steps to implement battery connection:

1. Remove insulation sleeve 18 mm for positive and negative cables based on recommended stripping length.
2. Connect all battery packs as unit requires, and use recommended battery capacity.
3. Insert battery cable to the battery connector of inverter and make sure the bolts are tightened with torque of 2-3 Nm. Make sure polarity at both the battery and the inverter/charge is correctly connected and battery cables are tightly screwed to the battery connector.

Please Note: Maximum current drawn by the inverter is 80A. If using EG4 Batteries, the maximum output is 100A. A 125A breaker is utilized to support maximum battery current of 100A. If using batteries other than EG4, please consult the manufacturer's manual to ensure proper breaker size.

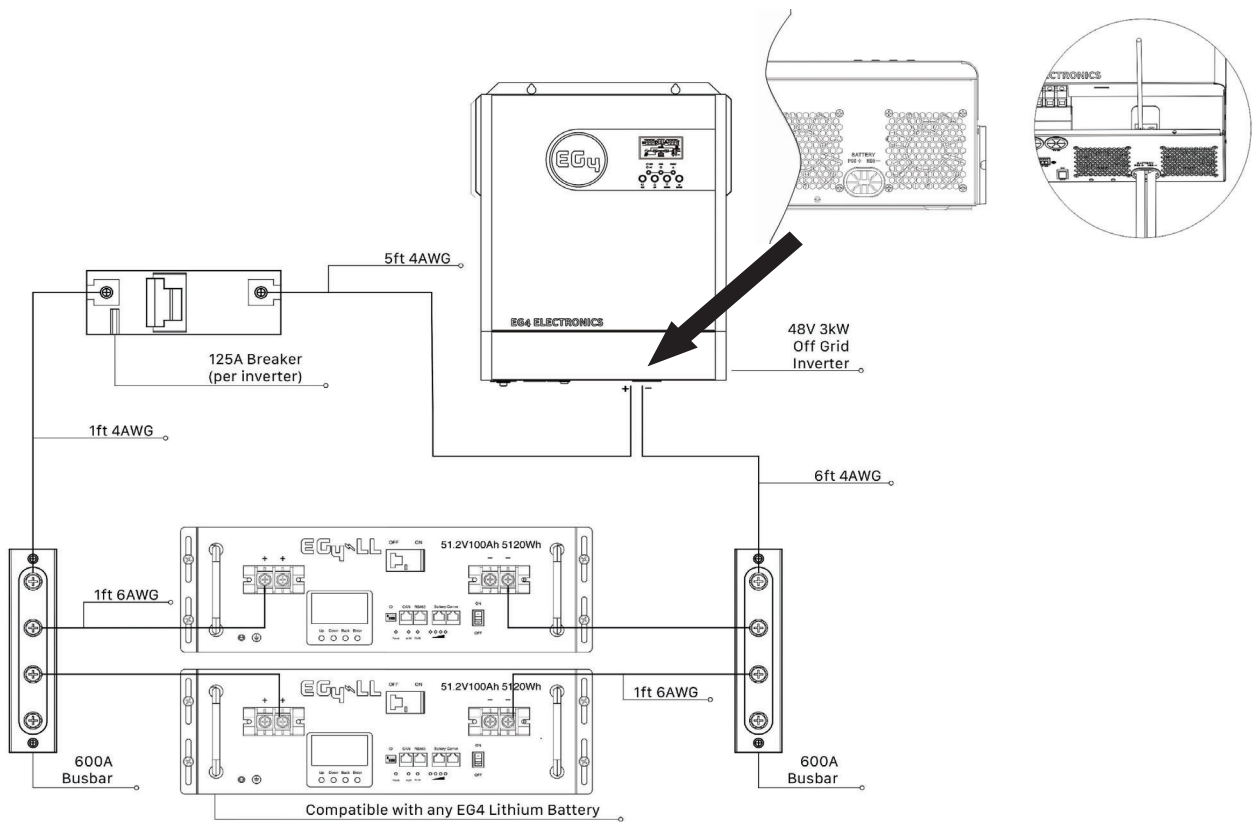

WARNING: Shock Hazard
 Installation must be performed with care due to high battery voltage.

CAUTION!! Do not place anything between the flat part of the inverter terminal. Overheating may occur.
CAUTION!! Do not apply anti-oxidant substance on the terminals before terminals are connected tightly.
CAUTION!! Before making the final DC connection or closing DC breaker/disconnector, be sure positive (+) is connected to positive (+) and negative (-) is connected to negative (-).

AC Input/Output Connection

CAUTION!! Before connecting to AC input power source, please install a **separate** AC breaker between inverter and AC input power source. This will ensure the inverter can be securely disconnected during maintenance and fully protected from AC input over current. Recommended specification of AC breaker is 30A on the input and 30A on the output.

CAUTION!! There are two terminal blocks with "IN" and "OUT" markings. Please do NOT mis-connect input and output connectors.

WARNING! We recommend all wiring be performed by a licensed professional.

WARNING! It is very important for system safety and efficient operation to use appropriately sized cable for AC input connection. To reduce risk of injury, please use the proper recommended cable size as below.

Suggested cable requirement for AC wires

Model	Gauge*	Torque Value	AC Breaker**
3000EHV-48	10AWG up to 32'/16.5m	1.4~ 1.6Nm	30A Input/ 30A Output

* 120V system, 3% max drop, assuming open air. AC output is 25A.

Please follow below steps to implement AC input/output connection:

1. Before making AC input/output connection, be sure to open (turn off) DC protector or disconnecter FIRST.
2. Remove insulation sleeve 10mm for six conductors. And shorten phase L and neutral conductor N 3 mm.
3. Insert AC input wires according to polarities indicated on terminal block and tighten the terminal screws. Be sure to connect the ground (PE) conductor (⊕) first.

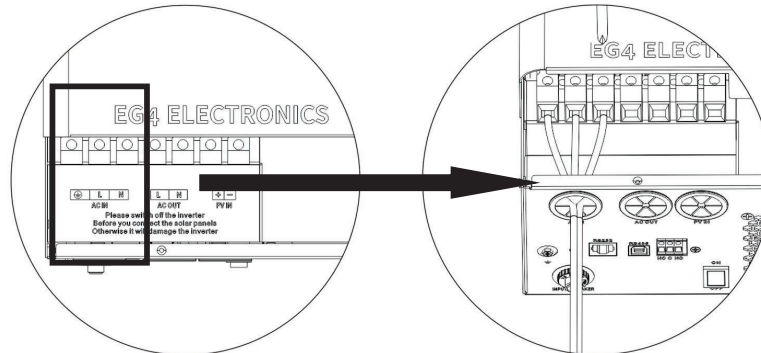

WARNING:

Be sure that AC power source is disconnected before attempting to hardwire it to the unit.

4. Then, insert AC output wires according to polarities indicated on terminal block and tighten terminal screws. Be sure to connect the ground (PE) conductor (⊕) first.



Ground (Green or Green with Yellow stripe)

L→LINE(Black for Line 1)(Red for Line 2 in 120/240 split-phase configuration)

N→Neutral (White or Gray) NOTE: Wire colors may vary.

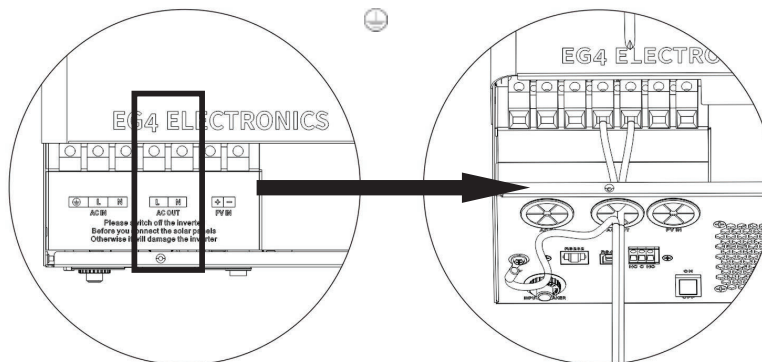

5. Make sure the wires are securely connected.

CAUTION: Important

Be sure to connect AC wires with correct polarity. If L and N wires are reversed, it may cause a utility short-circuit when these inverters are in parallel operation.

CAUTION: Appliances such as air conditioners require at least 2~3 minutes to restart because to have enough time to balance the refrigerant gas. If a power outage occurs and recovers in a short time, it may cause damage to your connected appliances. To prevent this damage, please check the appliance manufacturer for time-delay start function before installation. The inverter/charger will trigger an overload fault and cut off the output to protect your appliance which may cause internal damage to the appliance.

PV Connection

CAUTION: Before connecting to PV modules, please install a **separate** DC circuit breaker between the inverter and PV modules.

WARNING! We recommend all wiring be performed by a licensed professional.

WARNING! It is very important for system safety and efficient operation to use appropriate cable for PV module connection. To reduce risk of injury, please use the proper recommended cable size as below.

Model	Maximum Draw	Cable Size*	Torque
3000EHV-48	18A	10 AWG up to 50'/15.2m	1.4~1.6 Nm

Note - Do not operate inverter with only PV input to run loads. Either the addition of grid power, battery power or both is required for powering loads.

Solar Charging Mode	
INVERTER MODEL	3000EHV-48
Max. PV Array Open Circuit Voltage	500DC
PV Array MPPT Voltage Range	120VDC~450VDC

EXAMPLE: Using a 330W PV module and considering the 3 system parameters below -- the recommended module configurations would be as follows:

Solar Panel Spec.	SOLAR INPUT	Quantity of panels	Total input power	Inverter Model
- 330W 60 cell	Min in serial: 5 pcs, max. in serial: 10 pcs			
- Vmp: 33.25Vdc	6 pcs in serial	6 pcs	1980W	3000EHV-48
- VmpTC: -0.43%/C	8 pcs in serial	8 pcs	2640W	3000EHV-48
- Imp: 9.925A	10 pcs in serial	10 pcs	3300W	3000EHV-48
- Voc: 40.35Vdc	6 pieces in serial and 2 sets in parallel	12 pcs	3960W	3000EHV-48
- VocTC: - 0.31%/C	8 pieces in serial and 2 sets in parallel	16 pcs	5280W	3000EHV-48
- Isc: 10.79A				

* Assuming 10% voltage drop free air

** VOC max @ -25C/-14F = 46.6Vdc and Vmp min @ 40C/104F Ground mount = 27.5Vdc

PV System Parameters:

When selecting proper PV modules, please be sure to consider the following parameters:

1. Temperature adjusted open circuit voltage (VOC) of your PV modules must not exceed maximum MPPT open circuit voltage (VOC).
2. Temperature adjusted voltage at minimum power (VMP) of your PV modules should be higher than the start-up voltage of the inverter.
3. Calculate your panel configuration for your specific location and panel specifications.

PV Module Wire Connection:

Please follow below steps to implement PV module connection:

1. Remove insulation sleeve 10 mm/0.4" for positive and negative conductors.
2. Check correct polarity of connection cable from PV modules and PV input connectors. Then, connect positive pole (+) of connection cable to positive pole (+) of PV input connector. Connect negative pole (-) of connection cable to negative pole (-) of PV input connector.

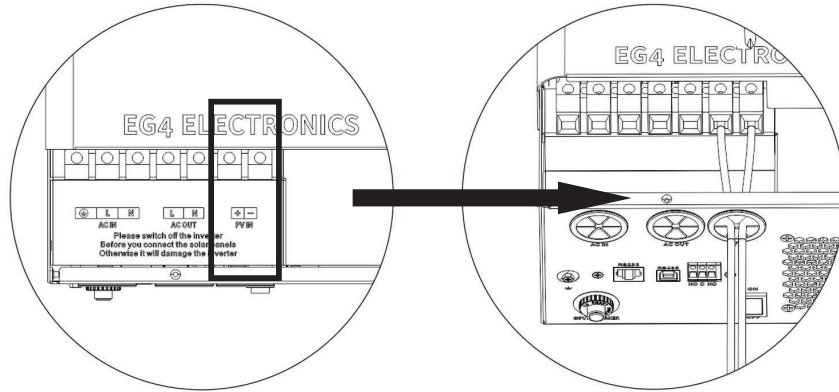
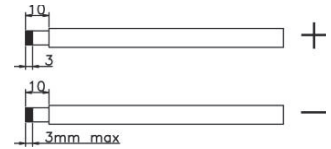

3. Make sure the wires are securely connected.

Final Assembly

After connecting all wirings, please put bottom cover back by screwing in the two screws as shown below.

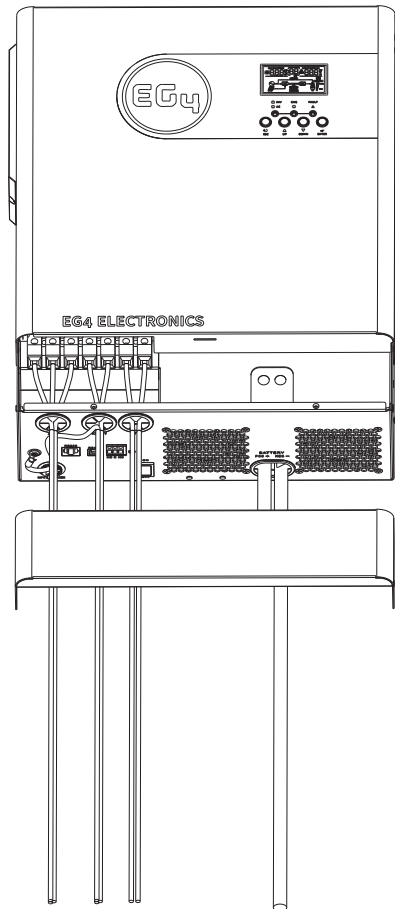

Dry Contact Signal

There is one dry contact (3A/250VAC) available on the rear panel which can be used to deliver signal to external device when battery voltage reaches warning level.

Unit Status	Condition		Dry contact port: 		
			NC & C	NO & C	
Power Off	Unit is off and no output is powered.		Close	Open	
Power On	Output is powered from Utility.		Close	Open	
	Output is powered from Battery or Solar.	Program 01 set as Utility	Battery voltage < Low DC warning voltage	Open	Close
			Battery voltage > Setting value in Program 13 or battery charging reaches floating stage	Close	Open
		Program 01 is set as SBU or SUB or Solar first	Battery voltage < Setting value in Program 12	Open	Close
			Battery voltage > Setting value in Program 13 or battery charging reaches floating stage	Close	Open

OPERATION

Power ON/OFF

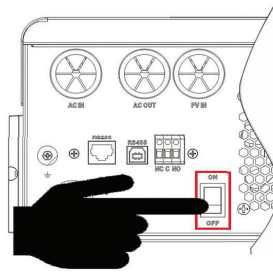

Once the unit has been properly installed and the batteries are connected properly, close (turn on) external battery breakers, power on the batteries and then simply press the On/Off switch (located on the button of the case) to turn on the unit.

Operation of Display Panel

The operation and display panel, shown in the below chart, is on the front panel of the inverter. It includes three indicators, four function keys, and a LCD display which indicates the operating status, input/output power information, et cetera.

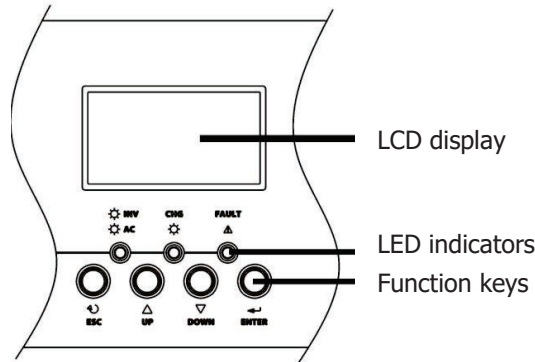

LED Indicator

LED Indicator		Messages	
☀️ AC / ☀️ INV	Green	Solid On	Output is powered by utility in Line mode.
		Flashing	Output is powered by battery or PV in battery mode.
☀️ CHG	Green	Solid On	Battery is fully charged.
		Flashing	Battery is charging.
⚠️ FAULT	Red	Solid On	Fault occurred in the inverter.
		Flashing	Warning condition occurred in the inverter.







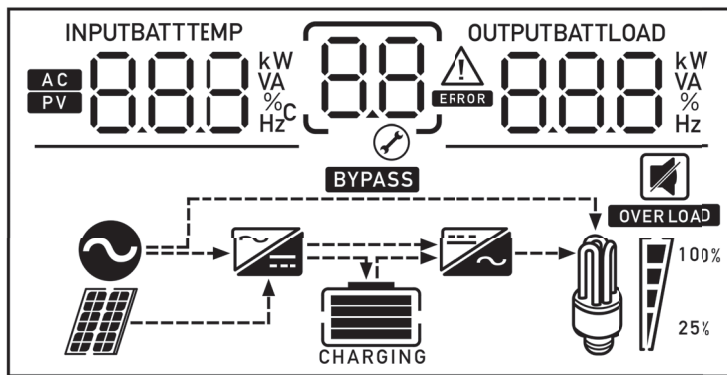

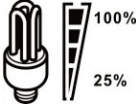

Function Keys

Function Key	Description
ESC	To exit setting mode
UP	To go to previous selection
DOWN	To go to next selection
ENTER	To confirm the selection in setting mode or to enter setting mode

LCD Display Icons







Icon	Function description
Input Source Information	
AC	Indicates the AC input.
PV	Indicates the PV input
INPUTBATT 888 kW VA %C Hz	Indicate input voltage, input frequency, PV voltage, battery voltage and charger current.
Configuration Program and Fault Information	
88 ⚙️	Indicates the program settings
	Indicates the warning and fault codes.
88 ⚠️ ERROR	Warning: 88 ⚠️ flashes the warning code.
88 ERROR	Fault: 88 ERROR lights the fault code
Output Information	
OUTPUTBATTLOAD 888 kW VA % Hz	Indicates the output voltage, output frequency, load percentage, load in VA, load in Watt and discharge current.
Battery Information	
	Indicates battery level: 0-24%, 25-49%, 50-74% and 75-100% for each bar in battery mode and charging status in line mode.

Load Information				
	Indicates overload.			
	Indicates the load level: 0-24%, 25-49%, 50-74% and 75-100%.			
	0%~24%	25%~49%	50%~74%	75%~100%
				
Mode Operation Information				
	Indicates unit is connected to the grid.			
	Indicates unit is connected to the PV panel.			
	Indicates load is directly connected to the grid.			
	Indicates the utility charger circuit is operational.			
	Indicates the DC/AC inverter circuit is operational.			
Mute Operation				
	Indicates unit alarm is disabled.			

Program Setting

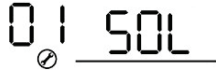
After pressing and holding the **ENTER** button for 3 seconds, the unit will enter setting mode. Press **UP** or **DOWN** button to select setting programs. Then, press **ENTER** button to confirm the selection or **ESC** button to exit.

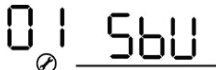
Setting Programs:

Program	Description	Selectable option	
01	Output source priority: To configure load power source priority	Solar first 	Solar energy provides power to the loads as first priority. If solar energy is not sufficient to power all connected loads, battery energy will supply power to the loads at the same time. Utility provides power to the loads only when one or all of the following conditions is in play: <ul style="list-style-type: none"> - Solar energy is not available - Battery voltage drops to either low-level warning voltage or the setting point in <i>program 12</i>.
		Utility first (default) 	Utility will provide power to the loads as first priority. Solar and battery energy will provide power to the loads only when utility power is not available.
		SBU priority 	Solar energy provides power to the loads as first priority. If solar energy is not sufficient to power all connected loads, battery energy will supply power to the loads at the same time. Utility provides power to the loads only when battery voltage drops to either low-level warning voltage or the setting point in program 12.
		SUB priority 	Solar energy provides power to the loads as first priority. If solar energy is not sufficient to power all connected loads, utility energy will supply power to the loads at the same time.



02	Maximum charging current: Configures the total charging current for solar and utility chargers. (Max. charging current = utility charging current + solar charging current)	10A 02 10 ^A	20A 02 20 ^A
		30A 02 30 ^A	40A 02 40 ^A
		50A 02 50 ^A	60A (default) 02 60 ^A
		70A 02 70 ^A	80A 02 80 ^A
03	AC input voltage range	Appliances (default) 03 APL	If selected, acceptable AC input voltage range will be within 70-160VAC.
		UPS 03 UPS	If selected, acceptable AC input voltage range will be within 80-160VAC.
		Generator 03 Gnt Note: Setting available with optional firmware update if unit is not already equipped.	If selected, acceptable AC input voltage range will be within 70-160VAC and compatible with generators. Note: Because generators are unstable, the output of the inverter may be unstable as well.
04	Power saving mode enable/disable	Saving mode disable (default) 04 SDS	If disabled, whether connected load is low or high, the on/off status of inverter output will not be effected.
		Saving mode enable 04 SEN	If enabled, the output of the inverter will be off when connected load is too low or not detected.
05	Battery type	05 AGn	AGM (default)
		05 FLd	Flooded
		05 USE	User-Defined
		05 LI 1	Factory Protocol
		05 LI 2	Pylontech New Protocol
		05 LI 3	Fox ESS Protocol
		05 LI 4	EG4 Protocol
05 LI 5	Pylontech/Dyness Old Protocol		

06	Auto restart when overload occurs	Restart disable (default) 06 Lfd	Restart enable 06 LFE
07	Auto restart when over temperature occurs	Restart disable (default) 07 tfd	Restart enable 07 tFE
08	Output voltage	110V 08 110 ^v	120V (default) 08 120 ^v
		115V 08 115 ^v	
09	Output frequency	50Hz (default) 09 50 _{Hz}	60Hz 09 60 _{Hz}
10	When 'auto' is selected the load will automatically bypass if utility is within the range defined by <i>Program 3</i>	manual(default) 10 nNL	auto 10 Ato
11	Maximum utility charging current	2A 11 2A	10A 11 10A
		20A 11 20A	30A (default) 11 30A
		40A 11 40A	50A 11 50A
		60A 11 60A	70A 11 70A
		80A 11 80A	

12	<p>Point back to Utility: (Low battery voltage level that switches the load to utility if SOL or SBU priority has been set in Program 1)</p> <p>Please Note: This is ONLY for AGM & FLD battery types</p>	<p>***Available options in 48V models: Setting range is from 44.0V to 57.2V for 48v model, but the setting value must be less than the value of Program 13.</p>	
		44V 12 440 ^v ⊗	45V 12 450 ^v ⊗
		46V (default) 12 460 ^v ⊗	47V 12 470 ^v ⊗
		48V 12 480 ^v ⊗	49V 12 490 ^v ⊗
		50V 12 500 ^v ⊗	51V 12 510 ^v ⊗
		52V 12 520 ^v ⊗	53V 12 530 ^v ⊗
		54V 12 540 ^v ⊗	55V 12 550 ^v ⊗
13	<p>Point back to Battery: (Charged battery voltage level that switches the load to battery if SOL or SBU priority has been set in Program 1)</p> <p>Please Note: This is ONLY for AGM & FLD battery types</p>	<p>***Available options in 48V models: Setting range is from 48V to full (the value of program26-0.4V), but the setting value must be more than the value of Program 12.</p>	
		Battery fully charged (default) 13 FUL ⊗	48 13 480 ^v ⊗
		49 13 490 ^v ⊗	50 13 500 ^v ⊗
		51 13 510 ^v ⊗	52 13 520 ^v ⊗
		53 13 530 ^v ⊗	54 13 540 ^v ⊗
		55 13 550 ^v ⊗	56 13 560 ^v ⊗
		57 13 570 ^v ⊗	58 13 580 ^v ⊗
		59 13 590 ^v ⊗	60 13 600 ^v ⊗
		61 13 610 ^v ⊗	62 13 620 ^v ⊗

16	Charger source priority: (To configure charger source priority)	If this inverter/charger is working in Line, Standby or Fault mode, charger source can be programmed as below:	
		Solar first 16 CS0	Solar energy will charge battery as first priority. Utility will charge battery only when solar energy is not available.
		Utility first 16 CUT	Utility will charge battery as first priority. Solar energy will charge battery only when utility power is not available.
		Solar and Utility (default) 16 SNU	Solar energy and utility will charge battery at the same time.
		Only Solar 16 OS0	Solar energy will be the only charger source regardless of whether utility is available or not.
If this inverter/charger is working in Battery mode or Power saving mode, only solar energy can charge battery. Solar energy will charge battery if it is available and sufficient.			
18	Buzzer mode	Mode1 BU2 18 nd1	Buzzer mute
		Mode2 BU2 18 nd2	The buzzer sounds when the input source changes or there is a specific warning or fault
		Mode3 BU2 18 nd3	The buzzer sounds when there is a specific warning or fault
		Mode4(default) BU2 18 nd4	The buzzer sounds when there is a fault
19	Auto return to default display screen	Return to default display screen (default) 19 ESP	If selected, no matter how users switch display screen, it will automatically return to default display screen (Input voltage /output voltage) after 1 minute of inactivity.
		Stay at latest screen 19 LEP	If selected, the display screen will stay at last user-selected screen.

20	Backlight control	Backlight on (default) 20 LON	Backlight off 20 LOF
23	Overload bypass: <i>When enabled, the unit will transfer to line mode if overload occurs in battery mode.)</i>	Bypass disable (default) 23 byd	Bypass enable 23 byE
25	Modbus ID Setting	Modbus ID Setting Range : 001(default)~247 n0d 25 001	
26	Bulk charging voltage (C.V. voltage)	48V models default setting: 56.4V CV 26 56.4 ^{BATT} v	
		If self-defined is selected in program 5, this program can be set up. Setting range is from 48.0V to 62.0V for 48v model. But the setting value must be more than or equal the value of program27. Increment of each click is 0.1V.	
27	Floating charging voltage	48V models default setting: 54.0V FLV 27 54.0 ^{BATT} v	
28	AC output mode (See Parallel Installation Guide on pg. 47 for more details)	Single: This inverter is used in single phase application. 28 S1C	Parallel: This inverter is operated in a single phase parallel system. (Need hardware support) 28 PARL
		L1 phase 28 3P1	The inverter is operated in L1 phase in 3-phase application
		L2 phase 28 3P2	The inverter is operated in L2 phase in 3-phase application
		L3 phase 28 3P3	The inverter is operated in L3 phase in 3-phase application
		28 2P1	The inverter is operated in L1 phase in split phase application
		28 2P2	The inverter is operated in L2 phase in split phase application

29	Low DC cut-off voltage	<p>48V models default setting: 42.0V</p>  <p>If self-defined is selected in program 5, this program can be set up. Setting range is from 40.0V to 54.0V for 48v model. The setting value must be less than the value of program12. Increment of each click is 0.1V.Low DC cut-off voltage will be fixed to setting value no matter what percentage of load is connected.</p>	
30	PV judge condition: (Only applies for setting "Solar first" in Program 1: Output source priority)	<p>One Inverter (Default):</p> 	<p>When "ONE" is selected, as long as one of inverters has been connected to PV modules and PV input is normal, parallel or 3-phase system will continue working according to rule of "solar first" setting.</p> <p>EXAMPLE: If two units are connected in parallel and set to "SOL" in output source priority. Then if one of two units has connected to PV modules and PV input is normal, the parallel system will provide power to loads from solar or battery power. If both of them are not sufficient, the system will provide power to loads from utility.</p>
		<p>All of Inverters:</p> 	<p>When "ALL" is selected, parallel or 3-phase system will continue working according to rule of "solar first" setting only when all of inverters are connected to PV modules.</p> <p>EXAMPLE: If two units are connected in parallel and set to "SOL" in output source priority. When selecting "ALL" in program 30, it is necessary to have all inverters connected to PV modules and the PV input normal in order to allow the system to provide power to loads from solar and/or battery power. Otherwise, the system will provide power to loads from utility.</p>

32	Bulk charging time (C.V stage)	Automatically (Default): 32 AUT	If selected, inverter will set the charging time automatically.
		5 min 32 5	The setting range is from 5 min to 900 min. Increment of each click is 5 min.
		900 min 32 900	
		If "USE" is selected in program 05, this program can be set up.	
33	Battery equalization	Battery equalization 33 EEN	Battery equalization disable (default) 33 EdS
		If "Flooded" or "User-Defined" is selected in program 05, this program can be set up.	
34	Battery equalization voltage	48V models default setting is 58.4V. Setting range is from 48V ~ 64V. Increment of each click is 0.1V. EV 34 64.0 ^{BATT} v	
35	Battery equalized time	60min (default) 35 60	Setting range is from 5min to 900min. Increment of each click is 5min.
36	Battery equalized timeout	120min (default) 36 120	Setting range is from 5min to 900 min. Increment of each click is 5 min.
37	Equalization interval	30days (default) 37 30d	Setting range is from 0 to 90 days. Increment of each click is 1 day
39	Equalization activated immediately	Enable 39 AEN	Disable (default) 39 AdS
		If equalization function is enabled in program 33, this program can be set up. If "Enable" is selected in this program, it is to activate battery equalization immediately and LCD main page will shows "EQ". If "Disable" is selected, it will cancel equalization function until next activated equalization time arrives based on program 37 setting. At this time, "EQ" will not be shown in the LCD main page.	
43	Setting SOC point back to utility	43 050 ^{BAT} %	Default 50%, 20%~50% Settable
44	Setting SOC point back to battery	44 095 ^{BAT} %	Default 95%, 60%~100% Settable
45	Low DC cutoff SOC	45 020 ^{BAT} %	Default 20%, 5%~30% Settable

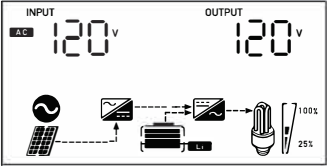
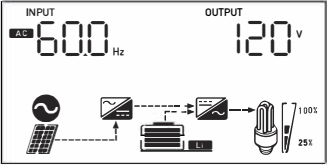
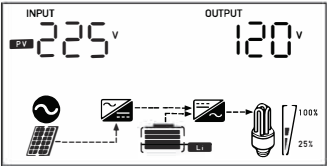
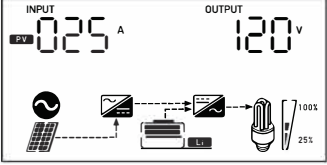
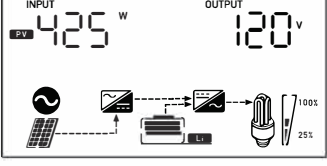

Display Setting

The LCD display information can be switched by pressing the UP or DOWN key. The selectable information is switched in the following order: input/output voltage, input frequency, PV voltage, MPPT charging current, MPPT charging power, charging current, charging power, battery voltage, output voltage, output frequency, load percentage, load in VA, load in Watt, DC discharging current, main CPU Version and second CPU Version.

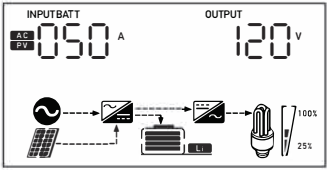
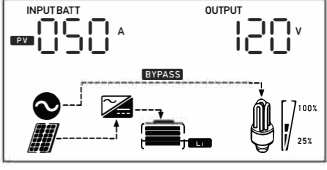
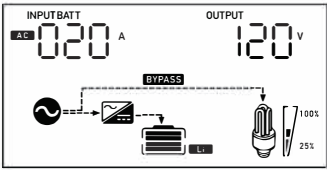
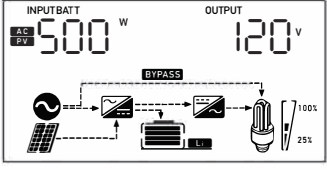
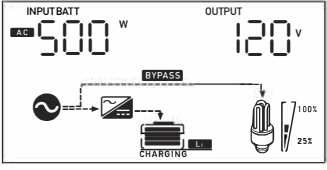
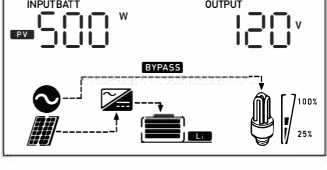

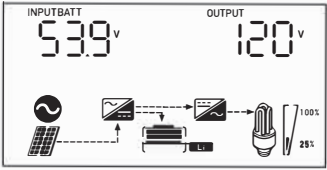
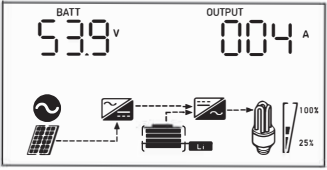
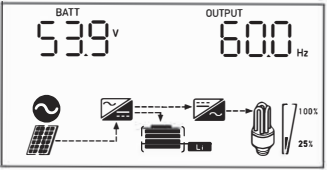
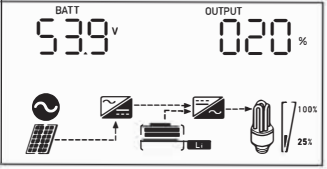

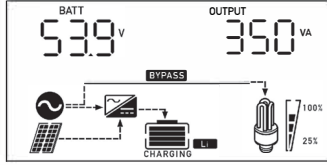
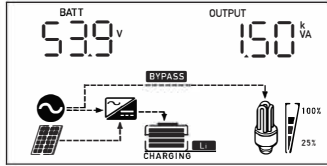
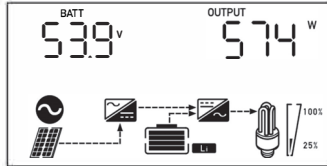
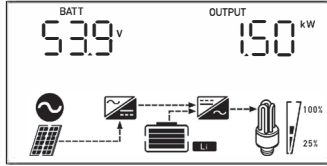

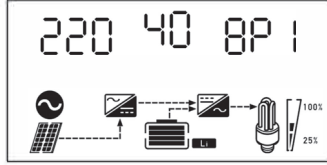

Application	Selectable Information	LCD Display
AC Input	Input Voltage/ Output Voltage (Default Display Screen)	 <p>Input Voltage = 120V Output Voltage = 120V</p>
	Input Frequency	 <p>Input Frequency = 60Hz</p>
PV Input	PV Voltage	 <p>PV Voltage = 225V</p>
	Mppt Charging Current	 <p>Current \geq 10A</p>
	MPPT Charging Power	 <p>MPPT Charging Power = 425W</p>

		<p>AC & PV Charging Current = 50A</p>  <p>PV Charging Current = 50A</p>  <p>AC Charging Current + 20A</p> 
<p>PV/AC Charging</p>	<p>Charging Current</p>	<p>AC & PV Charging Power = 500W</p>  <p>AC Charging Power = 500W</p>  <p>PV Charging Power = 500W</p> 
	<p>Charging Power</p>	

Battery Discharge	Output Voltage	 <p>Output Voltage = 120V</p>
	Output Current	 <p>Output Current = 4A</p>
AC Output	Output Frequency	 <p>Output Frequency = 60Hz</p>
	Load Percentage	 <p>Load Percentage = 20%</p>

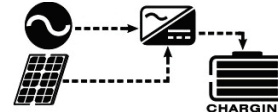
AC Output	Load in VA	<p>When connected load is lower than 1kVA, load in VA will present as xxxVA as in the image below.</p>  <p>When connected load is larger than 1kVA, load in VA will present as x.xkVA as in the image below.</p> 
	Load in Watt	<p>When load is lower than 1kW, load in W will present as xxxW as in the image below</p>  <p>When load is larger that 1kW, load in W will present as x.xkW as in the image below</p> 
System Specifications	Model Number	
	Firmware Version & Revision Number	

Operating Mode Description

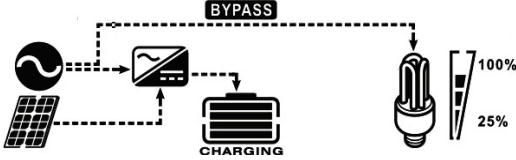
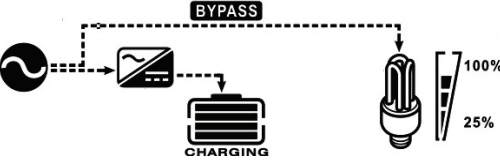
Operation mode	Description	LCD display
<p>Standby mode / Power saving mode</p> <p>Note: <i>*Standby mode: The inverter is not turned on yet but at this time, the inverter can charge battery without AC output.</i> <i>*Power saving mode: If enabled, the output of inverter will be off when connected load is pretty low or not detected.</i></p>	<p>No output is supplied by the unit but it still can charge batteries.</p>	<p>Charging by utility and PV energy.</p> 
		<p>Charging by utility.</p> 
		<p>Charging by PV energy.</p> 
		<p>No charging.</p> 
<p>Fault mode</p> <p>Note: <i>*Fault mode: Errors are caused by inside circuit error or external reasons such as over temperature, output short circuited and so on.</i></p>	<p>PV energy and utility can charge batteries.</p>	<p>Charging by utility and PV energy.</p> 
		<p>Charging by utility.</p> 
		<p>Charging by PV energy.</p> 
		<p>No charging.</p> 
<p>Line Mode</p>	<p>The unit will provide output power from the grid. It will also charge the battery at line mode.</p>	<p>Charging by utility and PV energy.</p> 
	<p>The unit will provide output power from the grid. It will also charge the battery at line mode.</p>	<p>Charging by utility.</p> 

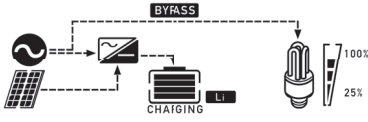
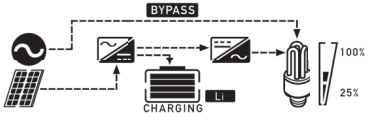
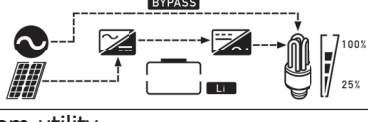
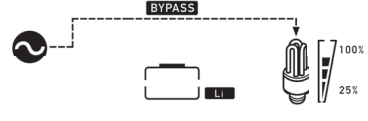
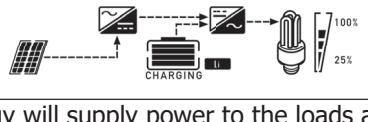
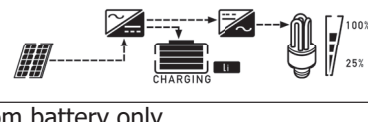
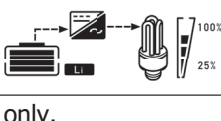
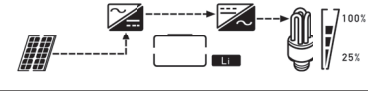
	<p>The unit will provide output power from the grid. It will also charge the battery at line mode.</p>	<p>If "solar first" is selected as the output source priority and solar energy is not sufficient to provide the load, then solar energy and utility will provide the loads as well as charge the battery at the same time.</p> 
<p>Line Mode</p>	<p>The unit will provide output power from the grid. It will also charge the battery at line mode.</p>	<p>If "SUB" is selected as the output source priority and the battery is connected, then solar energy will charge battery as first priority.</p> <p>If solar energy is sufficient for charging, then solar and the utility will provide the loads.</p> 
	<p>The unit will provide output power from the grid.</p>	<p>If "solar first" is selected as the output source priority and the battery is not connected, then solar energy and the utility will provide the loads.</p>  <p>Power from utility.</p> 
<p>Battery Mode</p>	<p>The unit will provide output power from battery and PV power.</p>	<p>Power from battery and PV energy.</p>  <p>PV energy will supply power to the loads and charge battery at the same time</p>  <p>Power from battery only.</p>  <p>Power from PV energy only.</p> 

Typical Application - 120V Single Phase in Parallel

For loads requiring 120V, up to twelve 3000EHV-48's can be set up in parallel.

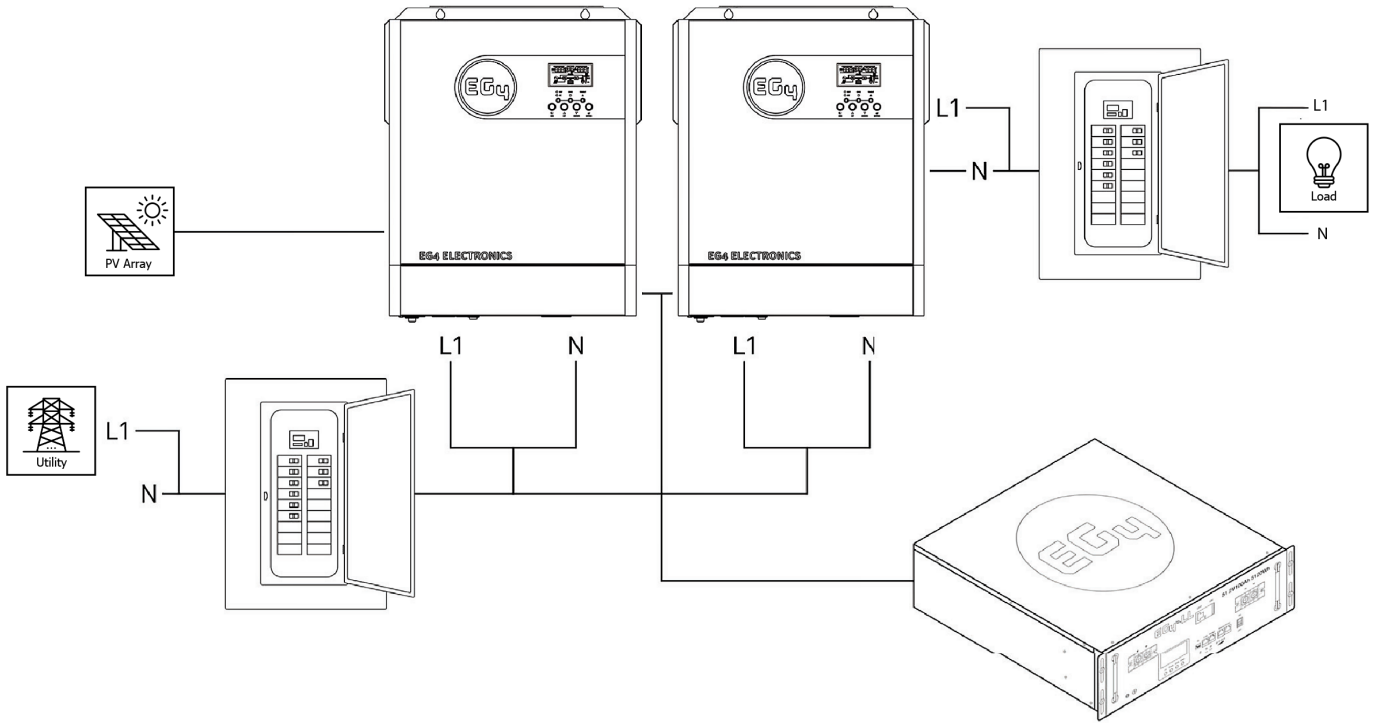

Typical Application - 240/120V Split Phase in Parallel

For loads requiring both 120V & 240V, up to six 3000EHV-48's per phase can be set up in parallel.

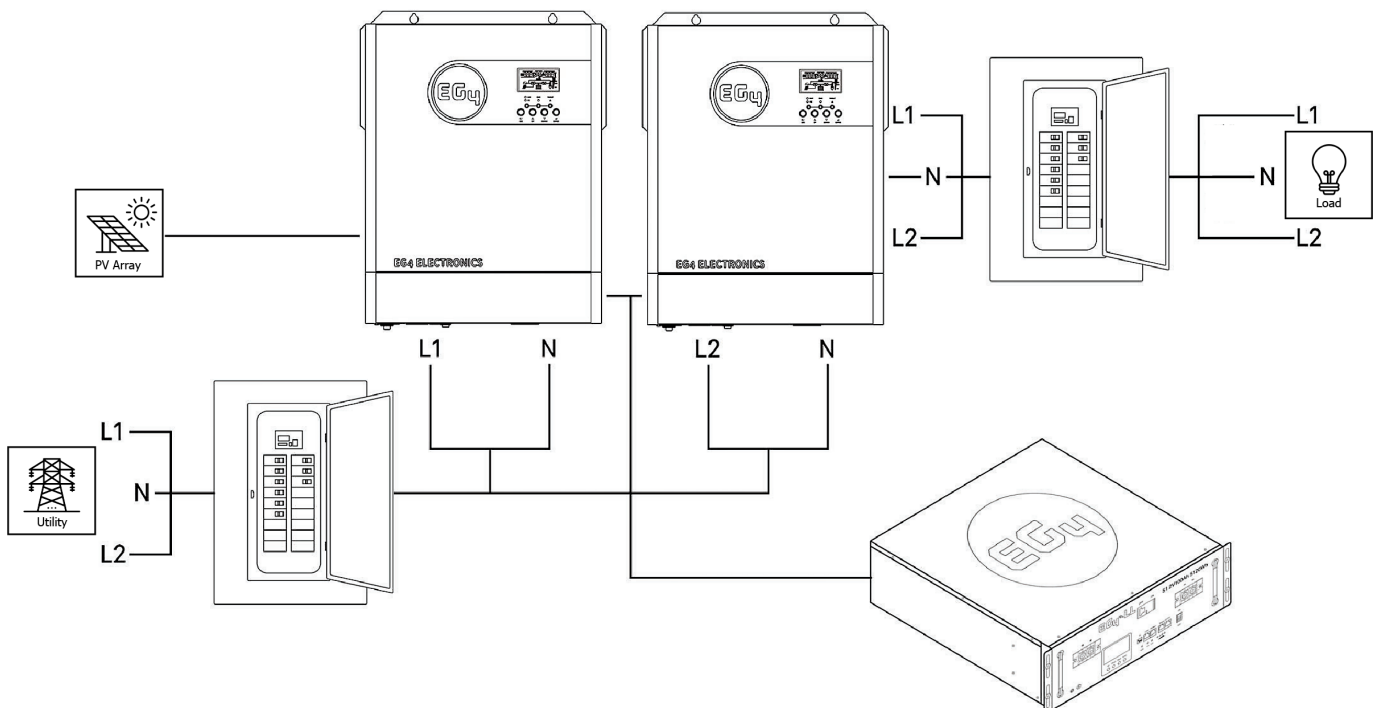

Parallel Installation Guide

1. Instruction

This inverter can be used in parallel with three different operation modes.

1. **Parallel Operation in Single Phase** ☒ up to 12 units. The supported maximum output power is 36KW/36KVA.
2. **Parallel Operation in Three Phase** - Maximum 12 units work together to support three-phase equipment. 10 units support one phase maximum. The supported maximum output power is 36KW/36KVA and one phase can be up to 30KW/30KVA.
3. **Parallel Operation in Split Phase** - up to 6 units per phase.

NOTE: If this unit is bundled with a parallel cable - the inverter's default operation mode is set to **parallel operation**.

2. Package Contents

In the parallel kit, you will find the following items:

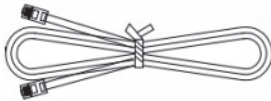

(1) Parallel communication cable

3. Mounting the Unit

When installing multiple units, please follow the chart below.

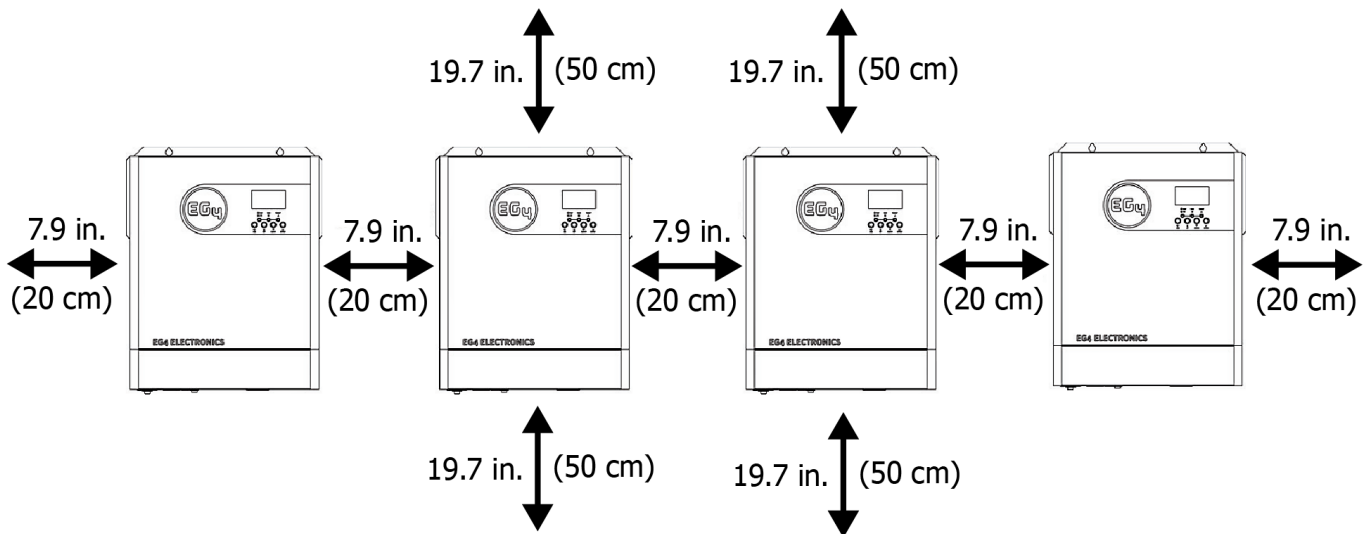

NOTE: For proper air circulation and heat dissipation, allow a clearance of approx. 20 cm/7.9" to the side and approx. 50 cm/19.7" above and below the unit. Be sure to install each unit at the same level.

4. Wiring Connection

The cable size of each inverter is shown as below:

Recommended battery cable and terminal size for each inverter:

WARNING: Be sure the length of all battery cables is the same. Inconsistent battery cable lengths will cause inconsistent voltage readings between inverter and battery, which could result in nonworking parallel inverters.

Stripping Length:

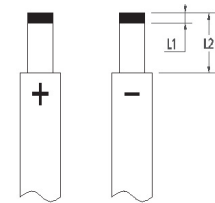

Model	Maximum Amperage	Battery capacity	Wire Size AWG/mm ²	Recommended Wire Length	L1 (mm/in)	L 2 (mm/in)	Torque value
3000EHV-48	80A	100AH	4AWG/25	6'/1.8m up to 15'/4.6m	3/0.1"	18/0.7"	2~ 3 Nm

Recommended AC input and output cable size for each inverter:

Model	Gauge	Torque Value	AC Breaker
3000EHV-48	10AWG up to 32'/9.75m	1.4~ 1.6Nm	30A Input/30A Output

Note - Connect inverters and batteries to a properly sized bus-bar(s)

CAUTION!! Please install a breaker between the battery and inverter and on the AC input side. This will ensure the inverter can be securely disconnected during maintenance and fully protected from over current. The recommended mounting location of the breakers is shown in the figures on the following pages:

Recommended Breaker Size Between Batteries & Inverter is 125 Amps Regardless of System Size.

Recommended main panel breaker specification of AC input with single phase:

1st Panel	up to 2 units	3 units	4 - 5 units	2nd Panel	up to 2 units	3 units	4 - 5 units
3000EHV-48	60A	90A	150A	3000EHV-48	60A	90A	150A

Note: Also, you can use 30A breaker for only 1 unit.

Recommended battery capacity - additional batteries required for larger storage capacities.

Inverter parallel numbers	2	3	4	5	6	7	8	9	10	11	12
Battery Capacity	300AH	400AH	500AH	600AH	800AH	900AH	1000AH	1100AH	1200AH	1300AH	1500AH

WARNING! Be sure that all inverters share the same battery bank. Otherwise, the inverters will transfer to fault mode.

Communicating with battery BMS in parallel system

- 1) Only supports common battery-type installation
- 2) Use RJ45 to USB-A cable to connect any one inverter in the paralleled system to your Lithium battery.

Set Master inverter battery type to "LI X" in LCD program 5. All other inverters should be set to default value "AGM". ** "X" = Battery Communication Protocol Number. For **EG4** batteries, set to **Li4**.

Note: Make sure only one inverter is connected via RJ45 to USB-A cable and set as Lithium in LCD program 5 and all others set to AGM.

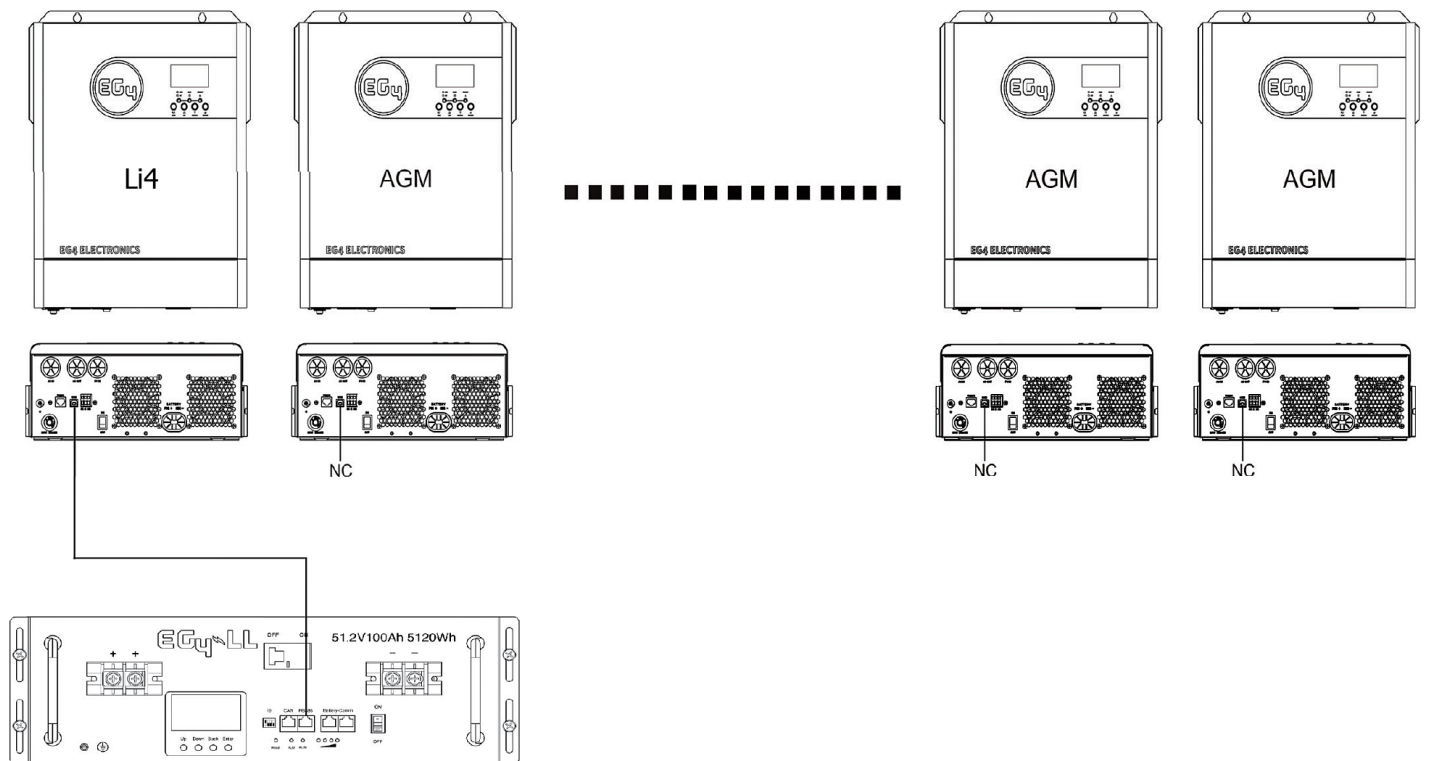

5. Parallel Operation in Single Phase (120V)

Program	Description	Selectable option	
28	AC output mode	28  <u>PARL</u>	Parallel: This inverter is operated in parallel system. Communication cables need to be connected as shown in the diagram below

Power Connection

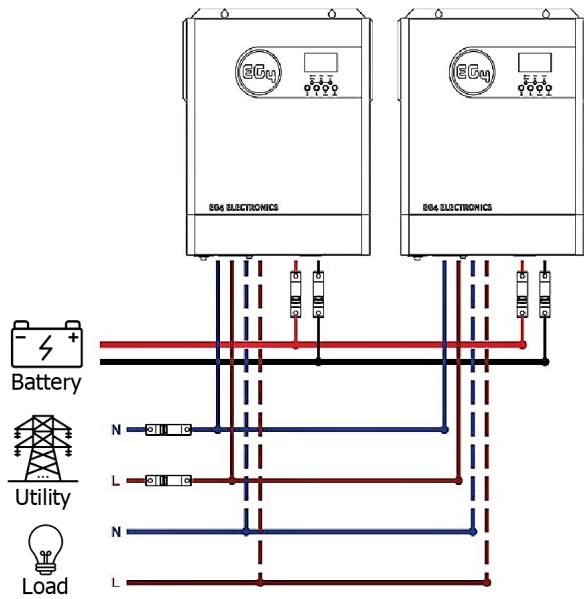

Communication Connection



Three inverters in Single Phase Parallel:

Power Connection

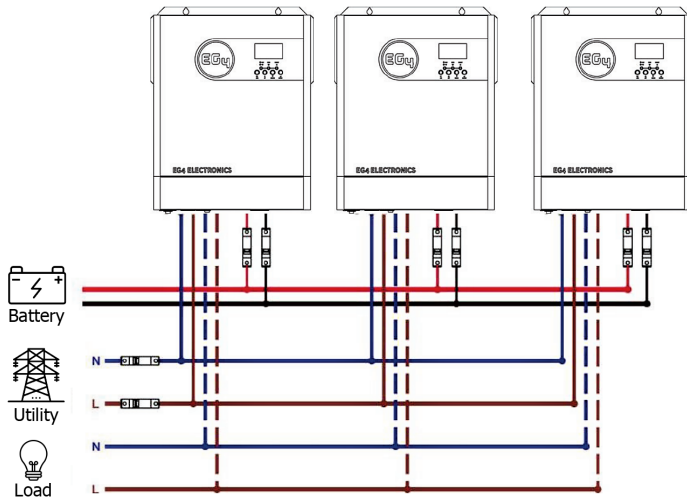

Communication Connection

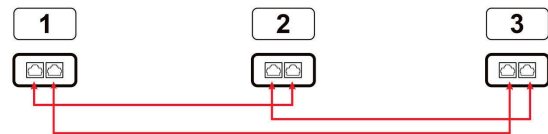

Four inverters in Single Phase Parallel: **Power Connection**

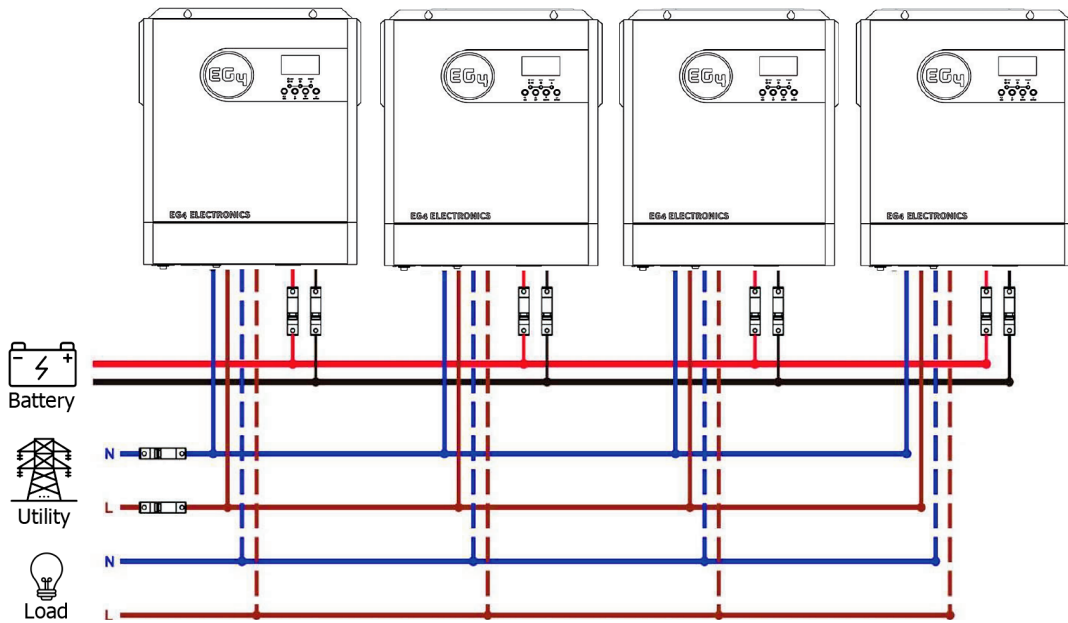

Communication Connection



Five inverters in Single Phase Parallel:

Power Connection

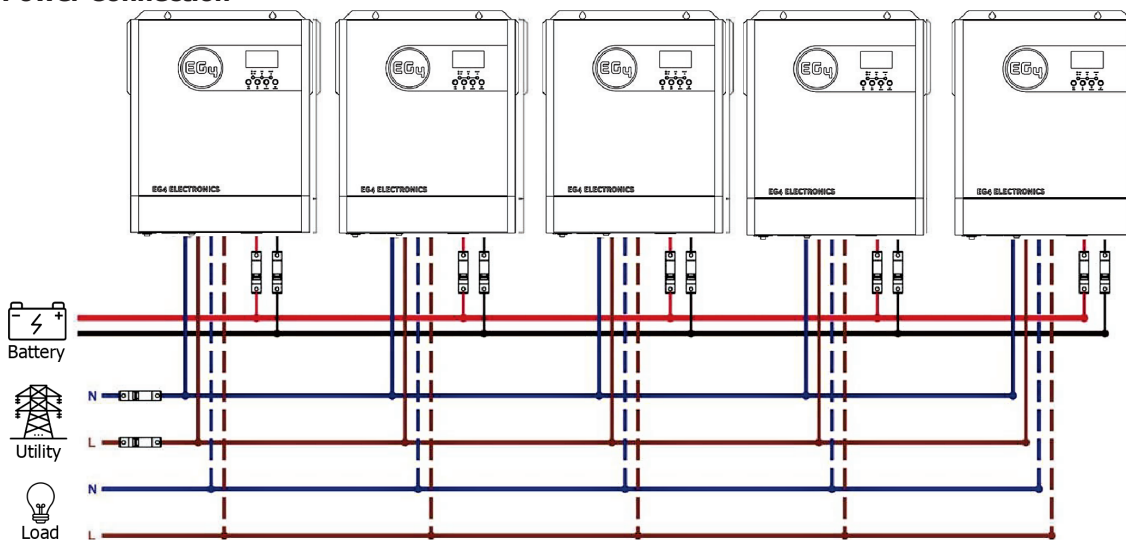

Communication Connection

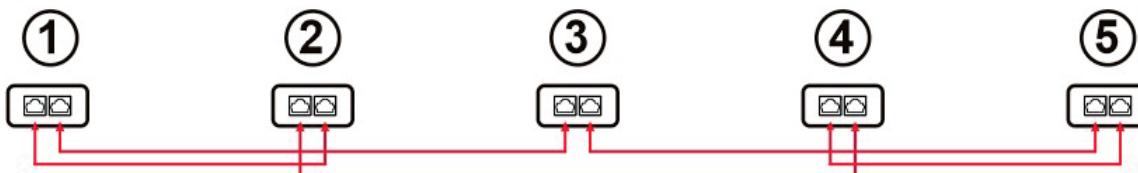

Six inverters in Single Phase Parallel:

Power Connection

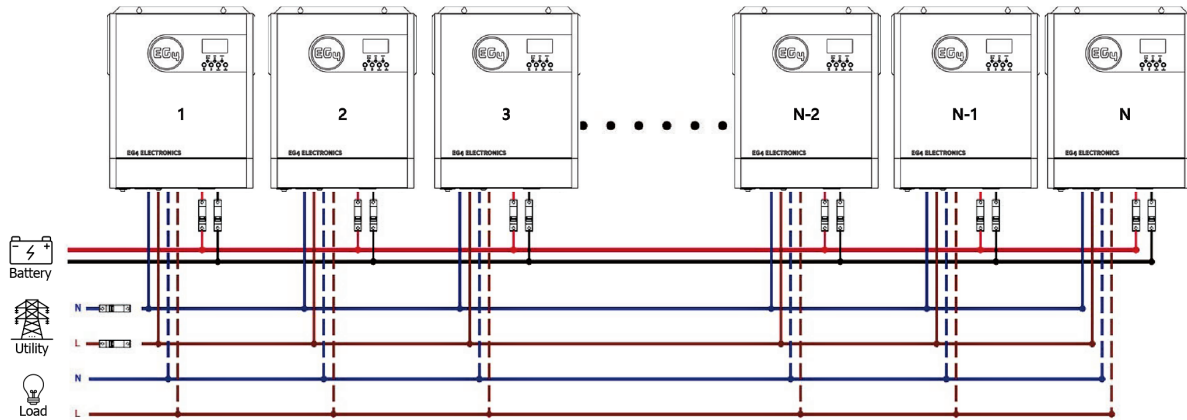

Communication Connection



Note: $N_{max}=12$ units Best practice is to minimize the number of jumps between inverters by alternating between 1 and 2 jumps on each inverter.

6. Support 3-phase equipment

Program	Description	Selectable option	
28	AC output mode	L1 phase 28 3P1 	The inverter is operated in L1 phase in 3-phase application
		L2 phase 28 3P2 	The inverter is operated in L2 phase in 3-phase application
		L3 phase 28 3P3 	The inverter is operated in L3 phase in 3-phase application

Power Connection: One inverter in each phase

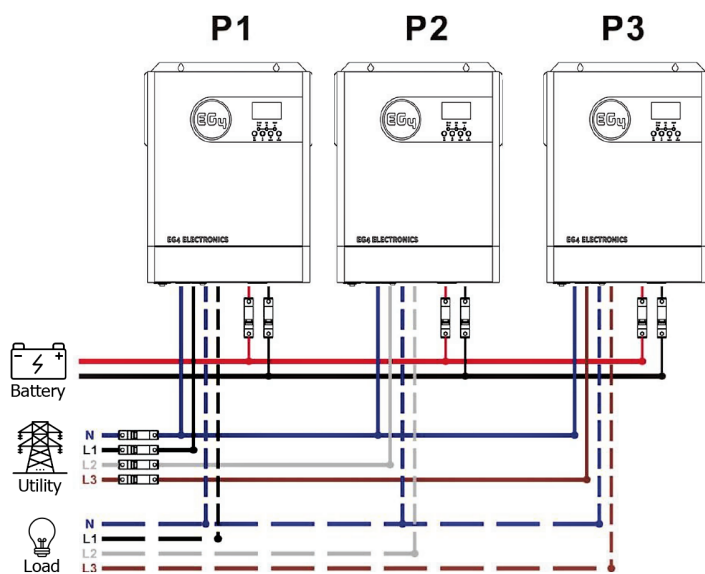

Communication Connection

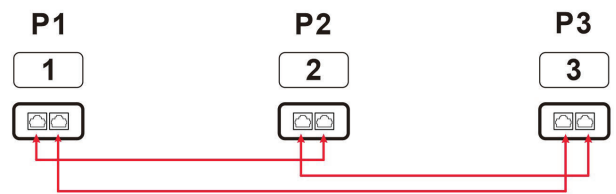

Three inverters in each phase:

Power Connection

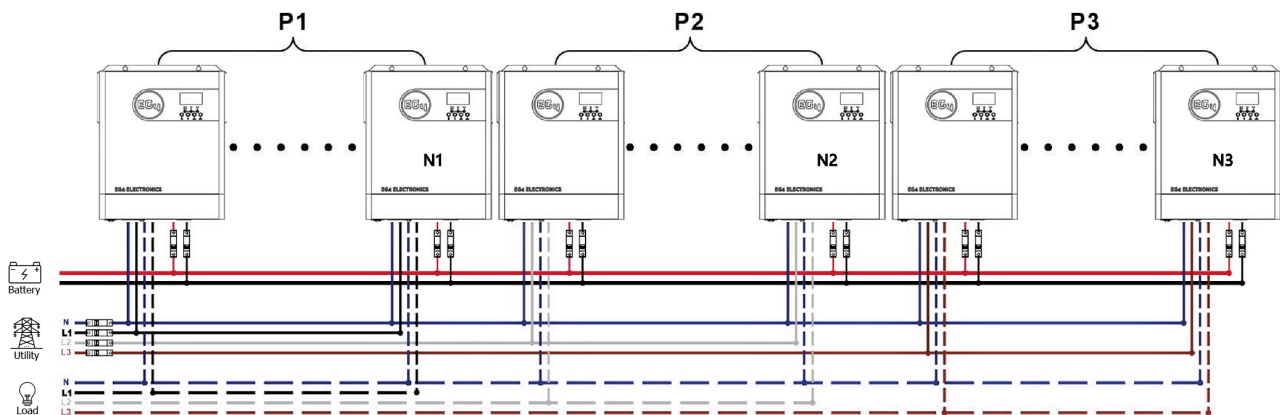

Note: Depending on load demand, there can be up to **10** inverters on any one phase.

P1: L1-phase, P2: L2-phase, P3: L3-phase.

$$N = N1 + N2 + N3, N_{max} = 12 \text{ units}$$

N1max=10units is in one phase and one inverter for the other two phases (N2=N3=1) :

Power Connection

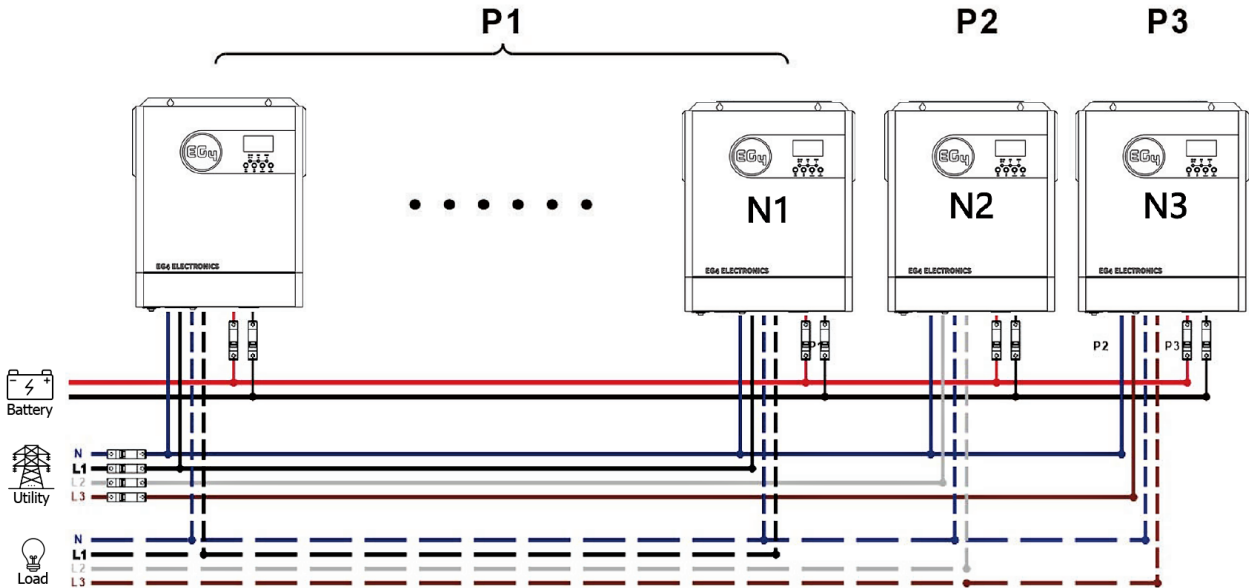

Note: Depending on load demand, there can be up to 10 inverters on any one phase..

P1: L1-phase, P2: L2-phase, P3: L3-phase.

$N=N1+N2+N3, Nmax=12units$

N1max=5 & N2max=6 units is in two phases and one inverter for the one phase (N3=1):

Power Connection

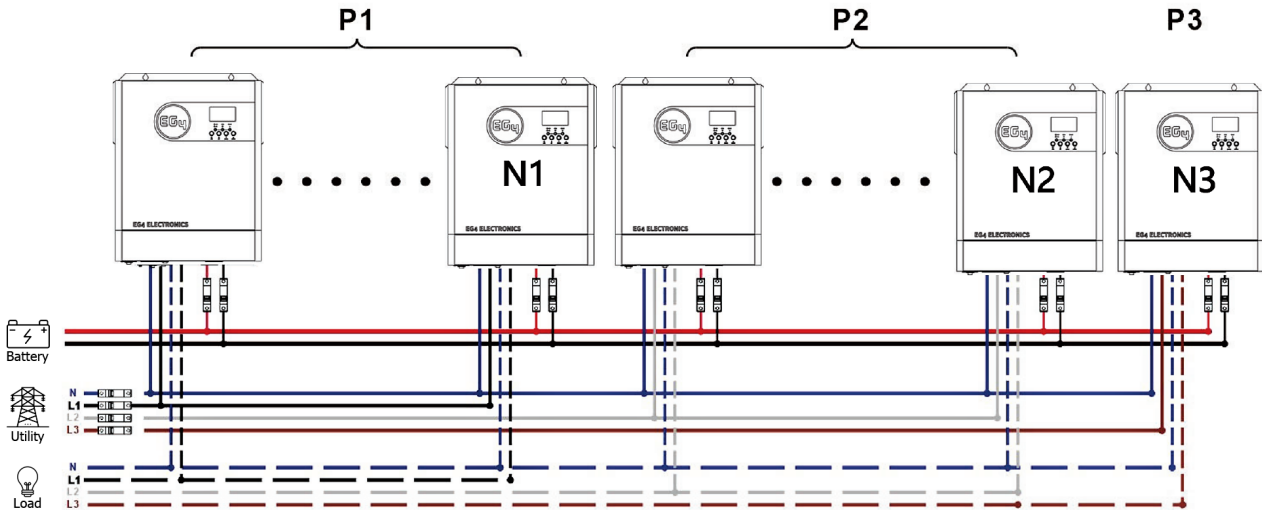

Communication Connection



7. Support for Parallel Split Phase (120V/240V)

Program	Description	Selectable option	
28	AC output mode	28 2P1	The inverter is operated in L1 phase in split application
		28 2P2	The inverter is operated in L2 phase in split application

Two inverters in parallel Split Phase

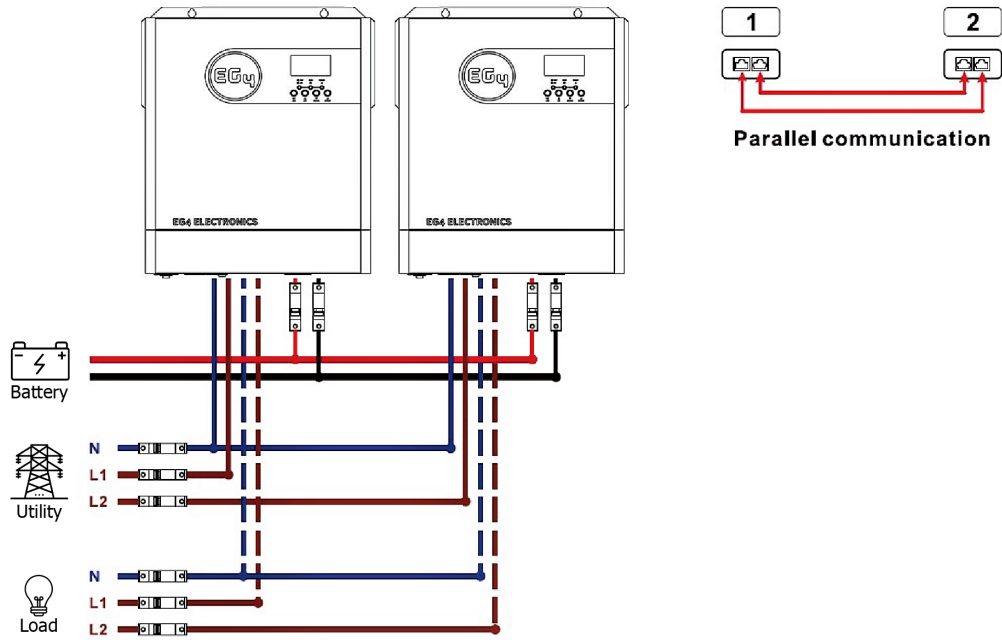

More than two inverters in parallel Split Phase

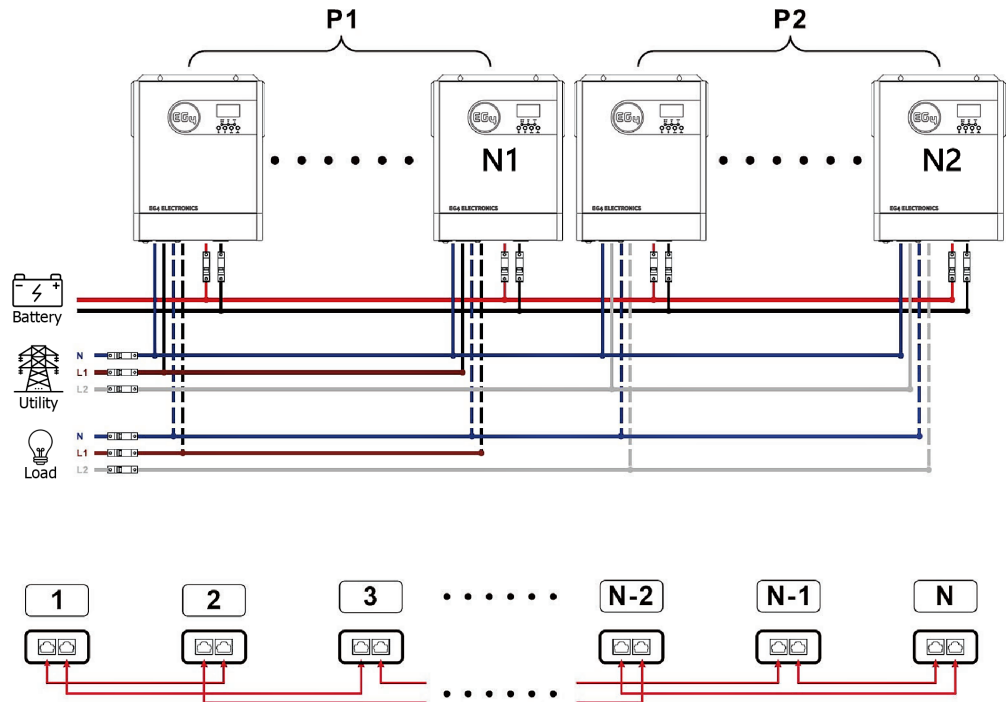

Note: Depending on load demand, there can be up to 6 inverters on any one phase.

2P1: L1-phase, 2P2: L2-phase; $N=N1+N2$, $N_{max}=12$ units

8. PV Connection





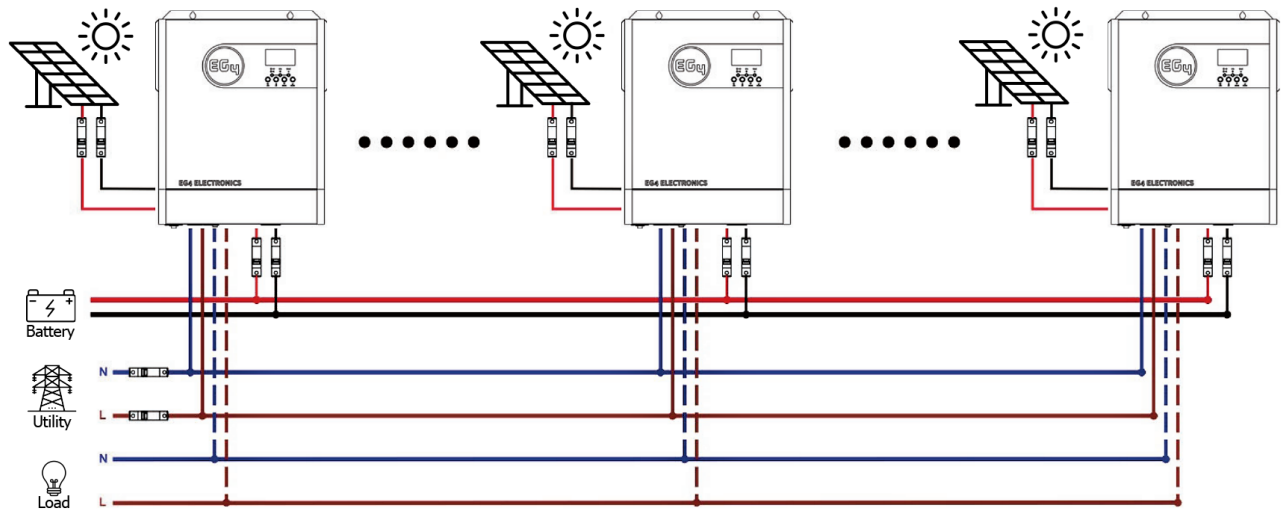

Please refer to user manual of single unit for PV Connection.

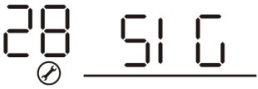

CAUTION: Each inverter should connect to PV modules separately.





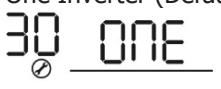

9. Split-Phase and 3 Phase LCD Setting and Display

Setting Program:



Program	Description	Selectable option	
28	AC output mode	Single: This inverter is used in single phase application. 	Parallel: This inverter is operated in parallel application. 
		L1 phase 	The inverter is operated in L1 phase in 3-phase application
		L2 phase 	The inverter is operated in L2 phase in 3-phase application
		L3 phase 	The inverter is operated in L3 phase in 3-phase application
			The inverter is operated in L1 phase in split-phase application
			The inverter is operated in L2 phase in split phase application

30	PV Operation (Only applies for setting "Solar first" in program 1: Output source priority)	One Inverter (Default): 	When "ONE" is selected, as long as one of the inverters has been connected to PV modules and PV input is normal, parallel or 3-phase system will continue working according to the rule of "solar first" setting. For example, two units are connected in parallel and set to "SOL" in output source priority. If one of two units has connected to PV modules and PV input is normal, the parallel system will provide power to loads from solar or battery power. If both of them are not sufficient, the system will provide power to loads from utility.
		All of Inverters: 	When "ALL" is selected, parallel or 3-phase system will continue working according to the rule of "solar first" setting only when all inverters are connected to PV modules. For example, two units are connected in parallel and set to "SOL" in output source priority. When selecting "ALL" in program 30, it is necessary to have all inverters connected to PV modules and the PV input normal to allow the system to provide power to loads from solar and battery power. Otherwise, the system will provide power to loads from utility.

Fault code display:

Fault Code	Fault Event	Icon on
24	Host loss	
25	Synchronization loss	
26	Incompatible battery type	
27	Firmware version inconsistent	

Warning code display:

Warning Code	Warning Event	Icon on
16	CAN communication loss	
17	AC output mode setting is different	
18	Battery voltage detected different	

10. Commissioning Parallel System

Step 1: Check the following requirements before commissioning:

- Ensure all wire connections are correct.
- Ensure the communications cable is connected.
- Ensure all AC In/Out breakers are open (off), and all neutral wires are connected.
- Ensure inverter DC breakers are closed (on), and turn on batteries.

Step 2: Turn on all inverters and wait for boot-up.

LCD display in Master unit	LCD display in Slave unit

NOTE: Master and slave units are randomly defined. If it is master the icon **P** blinks, if it is slave, the icon **P** is on steady

Step 3: Put the unit's power switch into the OFF position to place the unit in Standby Mode.

Step 4: Configure LCD program 28 on each inverter, press enter to save.

- Parallel Single Phase - Each unit is PAL
- Parallel Split Phase - L1 unit(s) set as 2P1 and L2 unit(s) set as 2P2 - $2P1 + 2P2 + N = \text{split phase } 120V/240V$
- Parallel 3 Phase - L1 unit(s) set as 3P1, L2 unit(s) set as 3P2, L3 unit(s) set as 3P3

LCD display in Master unit	LCD display in Slave unit

Step 5: Turn on all units sequentially starting with the Master.

Step 6: Switch on all AC Input breakers. If AC connection is detected and split phases are matched with unit setting, they will work normally. Otherwise, the AC icon on the LCD screen will be flashing and will not work in Line Mode.

Step 7: If there is no fault alarm, the system is ready to support split-phase equipment and is correctly installed.

Step 8: Please switch on all load side breakers. The system will start to provide power to the loads.

Note: To avoid overload occurring, before turning on breakers on load side, ensure all system components are operational.

Parallel Troubleshooting Guide

Below is a list of faults, warning codes, potential scenario issues, explanations of code meaning, as well as possible steps for correction.

In most cases a complete system reboot will remedy any erroneous errors. The steps for a complete system reboot are (in this order) as follows:

1. Inverter - set to standby (move power switch to OFF position)
2. PV/AC - input breaker OFF
3. Batteries - breaker OFF

Once the system has fully shut down, toggle the power switch between the **ON** and **OFF** position for approximately 30 seconds to drain the capacitors. When that step is complete, ensure your inverter's power switch is in the **OFF** position before restarting the system in the following order:

1. Batteries - breaker ON
2. PV/AC - input breaker ON
3. Inverter - breaker ON

Fault Codes

Code	Explanation	Troubleshooting Steps
Fault Code 24 - Host Data Loss	If Running more than one inverter, the host has stopped communicating or has gone offline.	<p>Do a complete system shutdown.</p> <p>Once the system has fully shut down, toggle the power switch between the ON and OFF position for approximately 30 seconds to drain the capacitors.</p> <p>When that is complete, ensure your inverter's power switch is in the OFF position and then restart your system.</p> <p>If this error is showing and a single inverter is being used, ensure that setting 28 is set to SIG.</p> <p><i>**If problem persists, contact your retailer.</i></p>

<p>Fault Code 25 - Synchronization Data Loss.</p>	<p>One or more of the inverters in parallel has stopped communicating with the others.</p>	<p>Ensure that no communications cables have come unplugged or have been removed from the inverters.</p> <p>Do a complete system shutdown.</p> <p>Once the system has fully shut down, toggle the power switch between the ON and OFF position for approximately 30 seconds to drain the capacitors.</p> <p>When that is complete, ensure your inverter's power switch is in the OFF position and then restart your system.</p> <p>Ensure that all of the inverters are in the same paralleling mode/phase mode.</p> <p><i>**If problem persists, contact your retailer.</i></p>
<p>Fault Code 26 - Incompatible Battery Type</p>	<p>It is possible that the battery type in setting 5 is incorrectly configured.</p>	<p>Navigate to setting 5 and configure your system for the correct battery type. EX: LI = Lithium, FLA = Lead Acid, AGM = Absorbed Glass Mat.</p> <p>Ensure that all of your battery connections are tight. <i>*With EG4 batteries we recommend the terminals be torqued to 6ft lbs or 8nm</i></p> <p><i>**If problem persists, contact your retailer.</i></p>
<p>Fault Code 27 - Firmware Version Inconsistent</p>	<p>It is possible, if using multiple inverters, that the firmwares are mismatched.</p>	<p>Check the versions of each inverter via the LCD Screen and ensure that all inverters have the same firmware version. If they are not all the same, contact your retailer and obtain an authorized version of the newest firmware – then update all inverters.</p> <p><i>**If problem persists, contact your retailer.</i></p>

Warning Codes

Code	Explanation	Troubleshooting Steps
Warning Code 16 - CAN Communications Loss	The inverter has stopped communicating with the BMS of the battery connected to it.	<p>Ensure that the correct communications cables are inserted into the proper ports of the inverter as well as the battery.</p> <p>Ensure that your battery's BMS supports communications to the EG4 Inverter.</p> <p>Ensure that the dip switches on your batteries are in the proper orientation.</p> <p><i>**If problem persists, contact your retailer.</i></p>
Warning Code 17 - AC Output Mode is Different.	Could indicate that the output is not in the correct phase mode for the attempted application.	<p>Switch the power switch on the inverter from the ON position to the OFF position (this will place the unit into 'Standby Mode')</p> <p>Once the inverter is standby, check Setting 28.</p> <ul style="list-style-type: none"> ● Single Unit = SIG ● Parallel System = PAL ● Split Phase System = 2P1 for the first leg and 2P2 for the second leg. <p>When this is complete, do a full system shut down (as outlined above) Once the system has fully shut down, toggle the power switch between the ON and OFF position for approximately 30 seconds to drain the capacitors.</p> <p>When that is complete, ensure your inverter's power switch is in the OFF position and then restart your system.</p> <p><i>**If problem persists, contact your retailer.</i></p>
Warning Code 18 - Difference in Battery Voltage	Indicates the inverter is reading a difference in battery voltage within the same stack.	<p>Remove all loads and disconnect AC input and PV input.</p> <p>Check the battery voltage of all inverters (test voltage at the lug on the inverter).</p> <p>If the values from all inverters are CLOSE, ensure that all battery cables are the same length, material type,</p>

<p>Warning Code 18 - Difference in Battery Voltage</p>	<p>Indicates the inverter is reading a difference in battery voltage within the same stack.</p>	<p>and size (all battery cables MUST be the same length for voltages to be equal across all batteries).</p> <p>Ensure that all cables are the same gauge (we recommend that cables between the battery and inverter are 4AWG - 2AWG depending on length)</p> <p>We recommend a 125A Breaker between your batteries and inverter. If you have such a breaker installed, ensure that your breaker is not BAD. You can determine this by temporarily bypassing the breaker and wiring straight to the inverter. If the issue is solved when bypassing, replace the breaker and restart your system.</p> <p>Ensure that all your battery's terminal connections are sufficiently tightened.</p> <p><i>*With EG4 batteries we recommend the terminals be torqued to 6ft lbs or 8nm</i></p> <p><i>** If problem persists, contact your retailer.</i></p>
--	---	---

Lithium Battery Settings

If choosing a lithium battery for the inverter, there are two modes supported.

1. Inverter to BMS communication with the battery via RS 485 Modbus
2. User defined setting using voltage levels (*Program Settings 26 and 27*)

Lithium Battery BMS Connection

There are two connections on the lithium battery, the RS485 port for BMS and the DC power cables.

Please follow the steps below to implement lithium battery connection:

- 1). Connect the battery terminal based on recommended battery cable and terminal size (same as Lead acid, see section Lead-acid Battery connection for details).
- 2). Connect the end of RS485 port of battery to BMS(RS485) communication port of inverter.

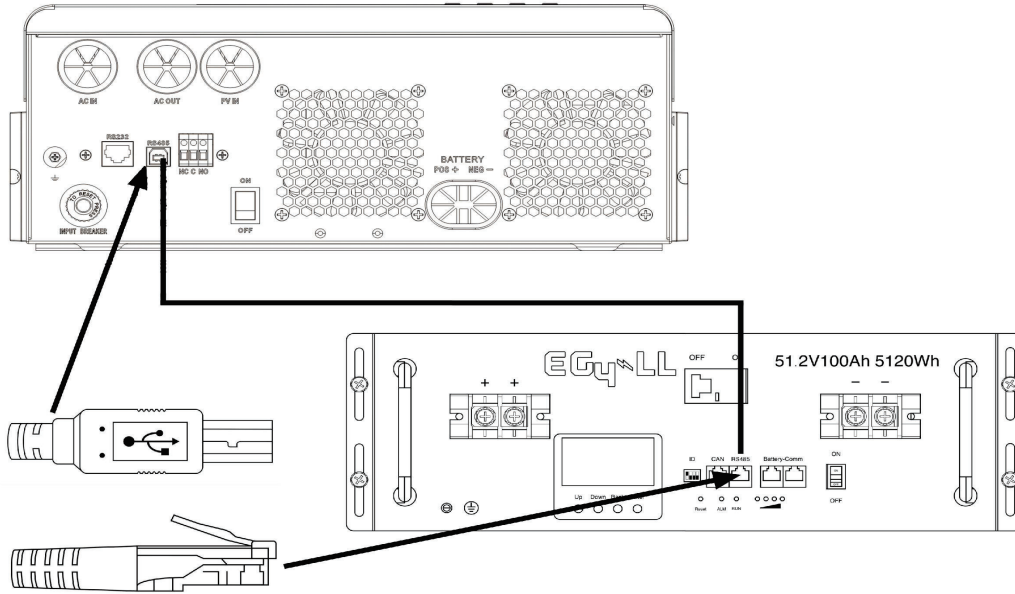

Lithium battery communication and setting

The BMS communication cable (*shown in the figure below) delivers information and signal between a lithium battery and the inverter. Utilizing the BMS will allow the following settings:

- Configure the charging voltage, charging current and battery discharge cut-off voltage according to the lithium battery parameters.
- Start or stop charging according to the status of lithium battery.

Connect one end of the RS485 to the battery and the other to the RS485 communication port of the inverter. Make sure the lithium battery RS485 port connects to the inverter Pin to Pin using the port pin assignment shown below:

Pin number	RS485 Port	Wire color
PIN1	RS485-B	Red
PIN2	RS485-A	White
PIN3	GND	Green
PIN4	GND	Yellow
PIN5	NC	NC

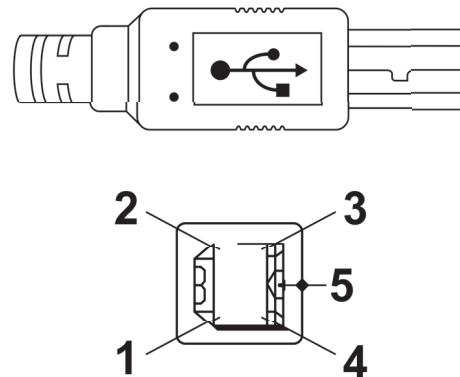

LCD setting

After connecting, finish and confirm the following settings:



Program	Description	Selectable option	
05	Battery type	05 AGM	AGM (default)
		05 FLd	Flooded
		05 USE	User-Defined
		05 LI 1	Standard communication Protocol form inverter supplier
		05 LI 2	Customized Protocol
		05 LI 3	Customized Protocol
		05 LI 4	EG4 Protocol
		05 LI 5	Customized Protocol
43	Setting SOC point back to utility source when selecting "SBU priority" or "Solar first" in program 01	43 BAT 050%	Default 50%, 20%~50% Settable
44	Setting SOC point back to battery mode when selecting "SBU priority" or "Solar first" in program 01	44 BAT 095%	Default 95%, 60%~100% Settable
45	Low DC cut-off SOC	45 BAT 020%	Default 20%, 5%~30% Settable

Note: Program 43/44/45 are only available with successful communication, they will replace the Program 12/13/29 function at the same time program 12/13/29 becomes unavailable.

LCD Display

If communication between the inverter and battery is successful, the following information will be shown on the LCD screen:

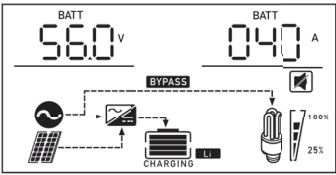
Item	Description	LCD display
1	Communication successful icon	
2	Lithium battery charging voltage	

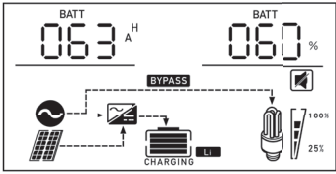
		Max lithium battery charging voltage is 56.0V.
3	Lithium battery charging current	 <p>Max lithium battery charging current is 40A.</p>
4	Lithium battery discharging is forbidden	 will flash once every 1 second
5	Lithium battery charging is forbidden	 will flash once every 2 second
6	Lithium battery capacity (AH)*Left Image	 <p>Lithium battery SOC is 63AH and 60%</p>
7	Lithium battery state of charge (%)*Right Image	

Settings for EG4 Lithium Batteries

1). EG4 lithium battery settings:

Dip Switch: There are 4 Dip Switches which set different baud rates and battery group addresses. If switch position is turned to the "OFF" position, it means "0". If switch position is turned to the "ON" position, it means "1".

EG4-LL Battery

- Dip 1, 2, and 3 are in the "ON" position*on = down
- Dip 4 is in the "OFF" position*off = up
- The 1-3 "ON" & 4 "OFF" configuration is to indicate Master battery status and is reserved for communications with the inverter.
- A Max of 16 batteries can communicate in a single battery bank

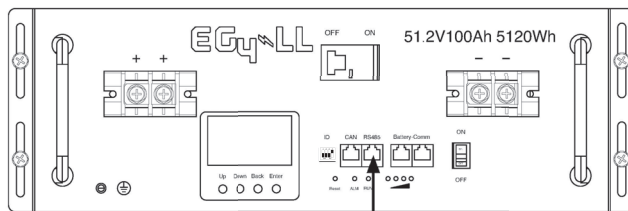
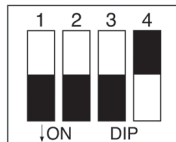

EG4-LifePower4 Battery

- Dip 1, 2, 3, and 4 are in the "OFF" position*off = down
- The ALL "OFF" position is to indicate the Master battery status and is reserved for communications with the inverter
- A Max of 16 batteries can communicate in a single battery bank.

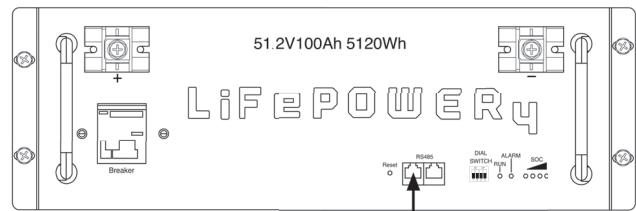
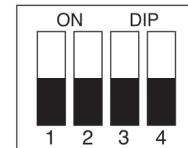

Please Note: If you change the dipswitches, you must power cycle the batteries for the BMS to recognize the new dipswitch address.

2). BMS Communication Guide

Step 1. Use the RS485 cable to connect inverter and EG4 battery.

Step 2. Turn on DC breaker between inverter and battery and switch on EG4 battery.

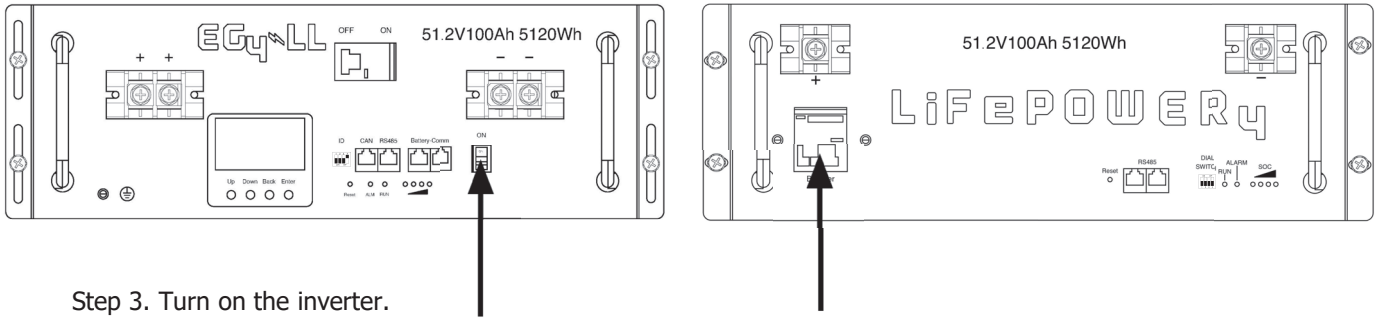

Step 3. Turn on the inverter.

Step 4. Be sure to select battery type as "Li4" in LCD program 5. All other inverters need to be set to "AGM".

If communication between the inverter and battery is successful, the battery icon **Li** on LCD display will light

Setting for lithium battery without communication

This example is used for lithium battery applications without BMS communication, please follow the steps below:

1. Before setting charging parameters, you must get the battery BMS specifications:

- A. Max charging voltage
- B. Max charging current
- C. Discharging protection voltage

2. Set battery type as "USE" (user-defined)

05	Battery type	AGM (default) 05 <u>AGM</u>	Flooded 05 <u>FLD</u>
		User-Defined 05 <u>USE</u>	If "User-Defined" is selected, battery charge voltage and low DC cut-off voltage can be set up in program 26, 27 and 29.

3. Set C.V voltage as Max charging voltage of BMS-**0.5V**.

26	Bulk charging voltage (C.V voltage)	default setting: 56.4V Cv <u>26</u> <u>56.4^v</u>
		If self-defined is selected in program 5, this program can be set up. Setting range is from 24.0V to 31.0V for 24v model and 48.0V to 62.0V for 48v model. But the setting value must be more than or equal the value of program 27. Increment of each click is 0.1V.



4. Set floating charging voltage as C.V voltage.

27	Floating charging voltage	default setting: 54.0V 
		If self-defined is selected in program 5, this program can be set up. Setting range is from 24.0V to the value of program 26 for 24v model and 48.0V to the value of program 26 for 48v model. Increment of each click is 0.1V.

5. Set Low DC cut-off voltage \geq discharging protection voltage of BMS+2V.

29	Low DC cut-off voltage	default setting: 42.0V 
		If self-defined is selected in program 5, this program can be set up. Setting range is from 20.0V to 27.0V for 24v model and 40.0V to 54.0V for 48v model. The setting value must be less than the value of program12. Increment of each click is 0.1V.Low DC cut-off voltage will be fixed to setting value no matter what percentage of load is connected.

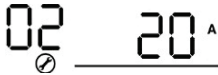
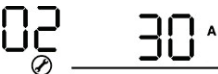
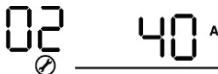
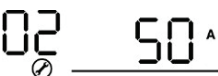
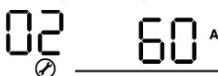
6. Set Max charging current which must be less than the Max charging current of BMS.

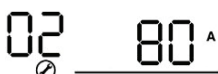
02	Maximum charging current: To configure total charging current for solar and utility chargers. (Max. charging current = utility charging current + solar charging current)	10A 	20A 
		30A 	40A 
		50A 	60A (default) 
		70A 	80A 

7. Setting voltage point back to utility source when selecting "SBU priority" or "Solar first" in program 01. The setting value must be \geq Low DC cut-off voltage+1V, or else the inverter will have a warning as battery voltage low.

12	Setting voltage point back to utility source when selecting "SBU priority" or "Solar first" in program 01. Please Note: This is ONLY for AGM & FLD battery types	Available options in 48V models: 46V (default) 
----	--	--

Troubleshooting Guide

Below is a list of faults, warning codes, potential scenario issues, explanations of code meaning, as well as possible steps for correction.

In most cases a complete system reboot will remedy any erroneous errors. The steps for a complete system reboot are (in this order) as follows:

1. Inverter - set to standby (move power switch to OFF position)
2. PV/AC - input breaker OFF
3. Batteries - breaker OFF

Once the system has fully shut down, toggle the power switch between the **ON** and **OFF** position for approximately 30 seconds to drain the capacitors. When that step is complete, ensure your inverter's power switch is in the **OFF** position before restarting the system in the following order:

1. Batteries - breaker ON
2. PV/AC - input breaker ON
3. Inverter - switch ON

Faults

Problem	Indicator	Explanation/Cause	Possible Solution
Unit shuts down automatically during start up.	LED's will be off. Alarm will sound for 3 seconds.	Indicates your battery voltage is too low	Verify battery voltage and SOC. If the battery has a low charge, charge the battery and then reattempt start up. <i>* If problem persists, contact your retailer.</i>
No response after power switch is set to ON	NO LED's or alarms will sound.	Could indicate that the battery voltage is too low to let the inverter boot up. Could also indicate that battery polarity is connected in reverse.	Ensure battery is connected to the inverter with the correct polarity (RED to +) and (BLACK to -) Ensure that the connections at both the battery and inverter are. <i>*With EG4 batteries we recommend the terminals be torqued to 6ft lbs or 8nm</i> Ensure that the SOC of the batteries is sufficient (greater than 20%) <i>** If problem persists, contact your retailer.</i>
Utility exists but inverter is in battery mode.	Input voltage is displayed as 0 on the LCD screen. Green LED is flashing.	Could indicate that the input protector is tripped.	Ensure the AC input breaker is not tripped and that all AC input wires are installed correctly into the unit.

Problem	Indicator	Explanation/Cause	Possible Solution
Utility exists but the inverter is in battery mode.	Green LED is flashing.	Could indicate an insufficient quality of AC power - either Generator or AC utility Grid	<p>Ensure the AC wires are an appropriate gauge (most use 10awg wire).</p> <p>Ensure that the AC lines are not too long. This could be causing a voltage drop off as well.</p> <p>If using a generator, ensure that it is running and verify the output voltage.</p> <p>Ensure that Setting 3 is set to APL and that the generator output voltage is within the range for that setting. (90-140vac)</p> <p>Ensure Setting 1 is set to UTL</p> <p><i>*If problem persists, contact your retailer.</i></p>
When the inverter is powered on, internal relay is switching on and off repeatedly.	LCD and LEDs are flashing.	Could indicate that batteries are not connected.	<p>Ensure that battery cables are installed correctly and are sufficiently tight.</p> <p><i>*With EG4 batteries we recommend the terminals be torqued to 6ft lbs or 8nm</i></p> <p><i>**If problem persists, contact your retailer.</i></p>



























Fault Codes

Code	Explanation	Troubleshooting Steps
Fault Code 07 - Overload Error	Indicates the load of the inverter has exceeded 110% of the load capacity.	<p>Do a complete system restart.</p> <p>Once the system has restarted and is online, ensure that loads are kept under 110% of operating capacity.</p>
Fault Code 05 - Output Short Circuited	Indicates that on L1 for single inverters or L1 & L2 for paralleled inverters that the output has a short.	<p>Ensure all wiring is going to the correct breaker and phases have not crossed. If running multiple inverters, test the continuity between the units using a multimeter.</p> <p>To run this test:</p> <ul style="list-style-type: none"> • Do a complete system shutdown as instructed above. • Set the multimeter to Ohm mode. • Take the Positive + (RED) probe and place it in L1 on the first inverter • Take the Negative - (BLACK) probe and place it on L1 on the second inverter. • The meter should read 0 • If it reads OL then the two lines are crossed or on the same bus causing the short. <p>Ensure that the appropriately sized wiring is being used (most use 10awg wiring).</p> <p><i>**If problem persists, contact your retailer.</i></p>
Fault Code 02 - Internal Temperature Alarm	Indicates that the internal temperature is over 212° Fahrenheit.	<p>Ensure the inverter has sufficient airflow and the vents/fans are not clogged or blocked by debris.</p> <p>Ensure that the fans spin freely.</p> <p>Ensure the ambient temperature is lower than 212° Fahrenheit.</p> <p><i>**If problem persists, contact your retailer.</i></p>













<p>Fault Code 03 - High Battery Voltage</p>	<p>Indicates the battery could be overcharged</p>	<p>Refer to the battery manufacturer's specs to ensure the inverter is configured to the battery's specifications.</p> <p>Ensure that the correct voltage of batteries for the system is being used. EX: a 48V inverter cannot support 24V batteries.</p> <p>Ensure the busbar is rated for the correct amperage being put on it. Over-amping a bus bar could cause a high battery voltage warning.</p> <p><i>**If problem persists, contact your retailer.</i></p>
<p>Fault Code 06 - Output Abnormal OR Fault Code 22</p>	<p>Indicates that the inverters output is lower than 190vac or greater than 260vac.</p>	<p>Check loads to ensure that it is not attempting to use a 240V load while only having 120V available. <i>*If connected loads are not an incorrect voltage contact your retailer.</i></p> <p>If running multiple inverters, test the continuity between the units using a multimeter. To run this test:</p> <ul style="list-style-type: none"> • Do a complete system shutdown as instructed above • Once system is off, turn on the breakers for AC output panel. • Set the multimeter to Ohm mode. • Take the Positive + (RED) probe and place it in L1 on the first inverter • Take the Negative - (BLACK) probe and place it on L1 on the second inverter. • The meter should read 0 • If it reads OL then the two lines are crossed or on the same bus causing the short.
<p>Fault Code 13 - Overcurrent or Surge</p>	<p>Indicates the inverter has detected an overcurrent event or a power surge.</p>	<p>Follow the directions above and restart the unit. Once the unit is restarted, if Fault 13 is still present - contact your retailer</p>

<p>Fault Code 14 - Bus Voltage Too Low</p>	<p>Indicates the voltage at the bus is insufficient to carry loads</p>	<p>Ensure that the inverter is not in standby mode (power switch in the OFF position)</p> <p>Ensure the inverter is not attempting to power loads that call for a higher voltage than is being produced.</p> <p>Follow directions at the beginning of this guide to do a complete system restart. Once the restart has been completed, if the problem persists - contact your retailer.</p>
<p>Fault Code 16 - Output Voltage is Unbalanced</p>	<p>Indicates that there are possibly multiple loads on a single leg of power.</p>	<p>Ensure that the loads are evenly balanced in the main load panel. EX: equal number of loads on L1 and L2</p> <p>Follow the directions at the beginning of this guide and do a full system restart. If after restart, the problem persists - contact your retailer.</p>

Fault Reference Code

Fault Code	Fault Event	Icon on
01	Over temperature of inverter module	
02	Over temperature of DCDC module	
03	Battery voltage is too high	
04	Over temperature of PV module	
05	Output short circuited.	
06	Output voltage is too high.	
07	Overload time out	
08	Bus voltage is too high	
09	Bus soft start failed	
10	PV over current	
11	PV over voltage	
12	DCDC over current	
13	Over current or surge	
14	Bus voltage is too low	
15	Inverter failed (Self-checking)	
16	Over DC voltage in AC output	
17	Reserved	
18	Op current offset is too high	
19	Inverter current offset is too high	
20	DC/DC current offset is too high	
21	PV current offset is too high	
22	Output voltage is too low	
23	Inverter negative power	
24	Host loss	
25	Synchronization loss	
26	Incompatible battery type	
27	Firmware version inconsistent	

Warning Indicator

Warning Code	Warning Event	Audible Alarm	Icon flashing
02	Temperature is too High	Beep three times every second	
04	Low battery	Beep once every second	
07	Overload	Beep once every 0.5 second	
10	Output power derating	Beep twice every 3 seconds	
15	PV energy is low	Beep twice every 3 seconds	
16	CAN communication loss	None	
17	AC output mode setting disparity	None	
18	Battery voltage disparity detected	None	
19	Lithium Battery communication failure	Beep once every 0.5 second	
20	Battery low and/or it is below the setting value of <i>Program 13</i>	Beep twice every 3 seconds	
E9	Battery equalization	None	
bP	Battery is not connected	None	

Wi-Fi Plug Pro

Quick Installation Guideline

P Packing Accessories Detail

P-1 WIFI Modular; P-2 Communication cable; P-3 Instruction book;



P-1

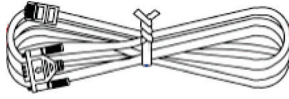

P-2



P-3

1. Installation Steps

1.1 Plug antenna into WIFI box body;

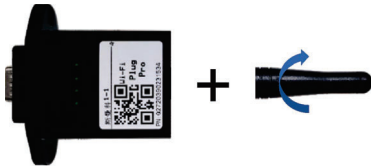

1.2 Plug communication cable into WIFI Modular ;

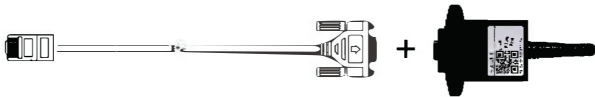

1.3 Plug the communication cable RJ45 head into the inverter RS232 port(RJ45 Port Type);

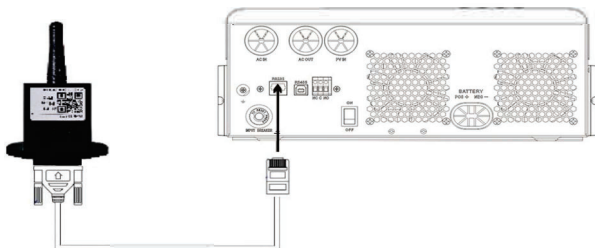

2. Wireless Router Connection

2.1 Download APP

① Scan the QR Code on the right side and download the APP.



SmartESS(iOS)



SmartESS(Android)

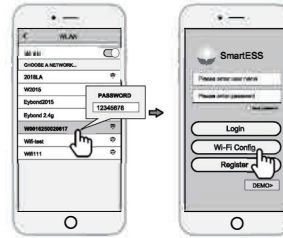

2.2 Connect Wi-Fi Datalogger

① Select the same number of Wi-Fi Plug Pro to connect on your phone WLAN. (InitialPassword:12345678)
② Open the APP, tap the **Wi-Fi Config** button to enter this page.

2.3 Network Setting

① Then tap the Network Setting button.
② According to the prompts, type in the information to finish the network setting.
③ After the Wi-Fi Plug Pro is restarted, reconnect the Wi-Fi which connected by step 2.1.

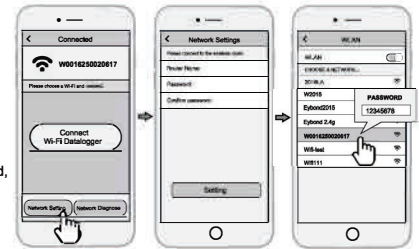

3. Create Account And Add Datalogger

3.1 Create Account

① Open the APP, tap the **Register** button to enter this page.
② According to the prompts, type in the information to create an account.

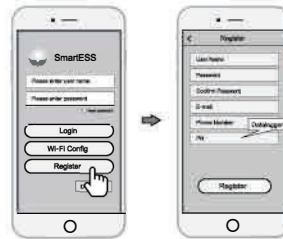

3.2 Add Datalogger

① Login the account and click the **Datalogger** button. Tap the "+" button on the top-right corner of the **Datalogger** page.
② Scan the PN on the Wi-Fi Plug Pro, or input it manually.
③ According to the prompts, type in the information to finish add datalogger.

